

AGENDA
REGULAR MEETING OF THE AMES CITY COUNCIL
COUNCIL CHAMBERS - CITY HALL - 515 CLARK AVENUE
AUGUST 27, 2019

NOTICE TO THE PUBLIC: The Mayor and City Council welcome comments from the public during discussion. **If you wish to speak, please complete an orange card and hand it to the City Clerk. When your name is called, please step to the microphone, state your name for the record, and limit the time used to present your remarks in order that others may be given the opportunity to speak.** The normal process on any particular agenda item is that the motion is placed on the floor, input is received from the audience, the Council is given an opportunity to comment on the issue or respond to the audience concerns, and the vote is taken. On ordinances, there is time provided for public input at the time of the first reading. In consideration of all, if you have a cell phone, please turn it off or put it on silent ring.

CALL TO ORDER: 6:00 p.m.

PROCLAMATION:

1. Proclamation for “National Overdose Awareness Day,” August 31, 2019

CONSENT AGENDA: All items listed under the Consent Agenda will be enacted by one motion. There will be no separate discussion of these items unless a request is made prior to the time the Council members vote on the motion.

2. Motion approving payment of claims
3. Motion approving Minutes of Regular Meeting of August 13, 2019
4. Motion approving Report of Change Orders for August 1 - 15, 2019
5. Motion approving Class C Liquor License Ownership Change - Texas Roadhouse, 519 South Duff Avenue
6. Motion approving Class C Beer Permit Ownership Change - Casey’s General Store #2298, 428 Lincoln Way
7. Motion approving Class E Liquor License Ownership Change - Casey’s General Store #2560, 3020 S Duff Avenue
8. Motion approving Class E Liquor License Ownership Change - Casey’s General Store #2905, 3612 Stange Road
9. Motion approving Class E Liquor License Ownership Change - Kum & Go # 1215, 4508 Lincoln Way
10. Motion approving new 6-month Special Class C Liquor License - Mandarin Restaurant, 415 Lincoln Way - Pending Inspections Approval
11. Motion approving new 12-month Special Class C Liquor License with Class B Native Wine, Outdoor Service, and Sunday Sales - The Love Club, LLC, 4625 Reliable Street
12. Motion approving new 12-month Special Class C Liquor License with Sunday Sales - New Hickory Holding Company, 1404 S Duff Avenue, Pending Dram Shop
13. Motion approving renewal of the following Beer Permits, Wine Permits, and Liquor Licenses:
 - a. Class E Liquor License with Class B Wine, Class C Beer and Sunday Sales - Kwik Stop Liquor & Groceries, 125 6th Street
 - b. Class E Liquor License with Class B Wine, Class C Beer and Sunday Sales - Hy-Vee Drugstore, 500 Main St

- c. Class E Liquor License with Class B Wine, Class C Beer and Sunday Sales - Cyclone Liquors, 626 Lincoln Way
 - d. Class C Liquor License with Outdoor Service and Sunday Sales - Grandpa Noodle Gallery, 926 S 16th Street
14. Motion approving request for Fireworks Permits for display from Jack Trice Stadium for ISU Home Football Games on the following dates:
 - a. Saturday, August 31
 - b. Saturday, September 14
 - c. Saturday, September 21
 - d. Saturday, October 5
 - e. Saturday, October 26
 - f. Saturday, November 16
 - g. Saturday, November 23
 15. Resolution approving Certificate of Consistency with City's 2014-19 CDBG Consolidated Plan on behalf of Youth & Shelter Services
 16. Resolution approving request to waive enforcement of the prohibition of motorized vehicles in Ada Hayden Heritage Park
 17. Resolution approving financial support as a sponsor for the 2019 Symposium on Building Inclusive Organizations in the amount of \$5,000
 18. Resolution approving Release of Subordinate Mortgage for property located at 712 Burnett Avenue, Ames, in connection with the Ames/Story County Partnership (ASCP) Affordable Housing Program
 19. Request for Run for the Roses:
 - a. Motion approving Blanket Temporary Obstruction Permit
 - b. Resolution approving closure of Mortensen Road between Dotson Drive to State Avenue and State Avenue between Lettie Street to Mortensen Road on October 13, 2019, from 6:00 a.m. to 2:00 p.m.
 20. Requests for Crafts & Draughts in Campustown on September 7, 2019:
 - a. Motion approving new 5-day Class B Beer License (September 7 - 11, 2019) - A&R Marketing, Inc, 217 Welch Avenue
 - b. Motion approving Blanket Temporary Obstruction Permit on Welch Avenue from Chamberlain Street to Hunt Street from 7:00 a.m. to 7:00 p.m.
 - c. Resolution approving waiver of electricity costs for the 200 block of Welch Avenue, including the Campustown Court area
 - d. Resolution approving the closure of 14 metered parking spaces and waiver of parking meter fees on Welch from 8:00 a.m. to 6:00 p.m.
 - e. Motion approving blanket Vending Permit on Welch Avenue from Chamberlain Street to Hunt Street
 - f. Resolution approving a waiver of fee for the blanket Vending Permit
 21. Resolution granting the Director of Electric Services authority to negotiate and approve an amendment with Macquarie Energy LLC of Houston, Texas, to extend the existing contract two or three years, if the overall contract cost falls to or below \$2.80/MMBtu
 22. Brookside Restroom Renovation Project:
 - a. Resolution approving reallocation of \$3,900 of savings from the completed Brookside Park Path Lighting Project

- b. Resolution approving preliminary plans and specifications for Brookside Restroom Renovation Project; setting September 25, 2019, as bid due date and October 8, 2019, as date of public hearing
- 23. Resolution approving preliminary plans and specifications for Methane Engine Generator Replacement project, setting September 25, 2019 as the bid due date and October 8, 2019 as the date of public hearing and award
- 24. Resolution awarding contract to Diamond Oil Company of Des Moines, Iowa, in an amount not to exceed \$150,000 for Electric Services Fuel Supply
- 25. Resolution awarding contract to RACOM Communications of Marshalltown, Iowa, for replacement of CyRide radio system in the amount of \$341,146
- 26. Resolution awarding three-year contract to Limble CMMS of Lehi, Utah, in an amount of \$68,796 for CMMS Software Updates for Power Plant
- 27. Resolution approving contract and bond for 2017/18 Shared Use Path System Expansion West Lincoln Way (Sunset Ridge Subdivision to North Dakota Avenue)
- 28. Resolution approving contract and bond for 2017/18 Water System Improvements Program #1 - Water System Transfers
- 29. Resolution approving contract and bond for 2018/19 Water System Improvements (Burnett, Murray)
- 30. Resolution approving contract and bond for 2014/15 Storm Water Facility Rehab (Somerset Subdivision Pond)
- 31. Resolution approving contract and bond for Wellhead Controls Improvements & Repainting Project
- 32. Resolution approving Change Order No. 5 in the amount of \$458,027.41 (inclusive of sales tax) to Helfrich Brothers Boiler Works, Inc., of Lawrence, Massachusetts, for Unit 7 Boiler Repair Project
- 33. Resolution approving completion of conditions for approval of the Final Plat of Wessex Subdivision and releasing security being held therefor
- 34. River Valley Park Softball Infield Renovation Project:
 - a. Resolution approving Change Order No. 1 to Contract with Iowa Cubs Sports Turf Management of Des Moines, Iowa in the amount of (\$7,850)
 - b. Resolution accepting completion of Contract with Iowa Cubs Sports Turf Management of Des Moines, Iowa, in the total amount of \$101,050
- 35. Resolution accepting completion of Fire Station 1 Parking Lot Reconstruction Project
- 36. Resolution accepting completion of Contract with ESA, Inc., for Asbestos Maintenance Service for Power Plant for FY 2014/15 through 2018/19 in the amount of \$562,128.91
- 37. Resolution accepting completion of Contract with TEI Construction Services, Inc., for Boiler Maintenance Services Contract for Power Plant for FY 2016/17 through 2018/19 in the amount of \$2,463,801.45
- 38. Resolution accepting completion of Contract with Total Insulation Mechanical, Inc., for Non-Asbestos Insulation and Related Services for Power Plant for FY 2014/15 through FY 2018/19 in the amount of \$182,575.96

PUBLIC FORUM: This is a time set aside for comments from the public on topics of City business other than those listed on this agenda. Please understand that the Council will not take any action on your comments at this meeting due to requirements of the Open Meetings Law, but may do so

at a future meeting. The Mayor and City Council welcome comments from the public; however, at no time is it appropriate to use profane, obscene, or slanderous language. The Mayor may limit each speaker to three minutes.

ADMINISTRATION:

- 39. Resolution of support for Healthy Life Center
- 40. Resolution approving/motion denying request from Iowa State University to collaborate and co-brand the Principles of Community for inclusion in public buildings and make the campaign available to private organizations that are asked to participate

FINANCE:

- 41. General Obligation Corporate Purpose Bonds, Series 2019A:
 - a. Presentation of bids received
 - b. Resolution accepting bids and authorizing the sale and issuance of General Obligation Bonds in an amount not to exceed \$11,880,000

FIRE:

- 42. Update on changes to Rental Code:
 - a. Discussion regarding three possible changes
 - b. Discussion regarding adding carbon monoxide detectors to requirements
 - c. Public input

FLEET SERVICES:

- 43. Fleet Services B100 Pilot Program; to reduce vehicle carbon and NOx gas emissions by year round use of 100% biodiesel (B100) in selected City vehicles:
 - a. Resolution approving request to equip five existing City snow plow trucks, as selected pilot vehicles, with the Optimus System, allowing the trucks to burn B100 year-round; equipment and installation paid for by the Ames based corporation, Renewable Energy Group (REG), at \$12,000 each vehicle
 - b. Resolution waiving Purchasing Policies pertaining to bidding and approving a sole-source contract with Optimus Systems, Inc., to install system on selected City vehicles; train City Fleet technicians to install and work on the system; collect real-time data about the fuel use, system performance, and location of the pilot vehicles
 - c. Resolution waiving Purchasing Policies pertaining to bidding and approving a sole-source contract with REG to be the sole provider of biodiesel for the 5 selected trucks throughout the 3-year pilot program; for REG to pay for the system, installation, and training of the Optimus System on the 5 pilot vehicles; lease one (1) 12,000 gallon, above-ground fuel kiosk to the City for \$1 per year during the pilot program; place the fuel kiosk at the Public Works Maintenance Facility at 2207 Edison Street, Ames

PLANNING & HOUSING:

- 44. Resolution approving/motion denying Preliminary Plat for Iowa State University Research Park Phase Four, 1st Addition (3898 University Boulevard and 3499 South Riverside Drive)
- 45. Discussion of Vacation Rentals (Tabled from July 23, 2019)

HEARINGS:

46. Hearing on vacation of 180' x 16' alley right-of-way north of Lincoln Way and east of Elm Avenue:
 - a. First passage of ordinance to vacate right-of-way
47. Hearing on 2018/19 Asphalt Street Pavement Improvements:
 - a. Resolution approving final plans and specifications and awarding contract to Con-Struct Inc., in the amount of \$1,002,621.40
48. Hearing on 415 Stanton Avenue Contract Rezoning Agreement:
 - a. Motion to continue the hearing until September 10, 2019
49. Hearing on Amendment to Adaptive Reuse/Major Site Development Plan for North Grand Mall located at 2801 Grand Avenue:
 - a. Resolution approving Adaptive Reuse/Major Site Development Plan with stipulations recommended by staff
50. Hearing on proposed amendments to the Zoning Code (Chapter 29) and the Rental Code (Chapter 13), and the creation of a new Chapter 35 to establish zoning definitions, standards, and enforcement procedures for permitting/licensing of guest lodging in specific zoning districts(Continued from July 23, 2019, and August 13, 2019):
 - a. First passage of ordinance amending Chapter 29 pertaining to guest lodging in specified zoning districts
 - b. First passage of ordinance amending Chapter 13 pertaining to guest lodging
 - c. First passage of ordinance creating Chapter 35 pertaining to guest lodging
51. Hearing on Nuisance Assessments:
 - a. Resolution assessing costs of snow/ice removal and certifying assessments to Story County Treasurer

ORDINANCES:

52. First passage of Ordinance establishing parking regulations for Scenic Valley Subdivision, Fourth Addition

DISPOSITION OF COMMUNICATIONS TO COUNCIL:

COUNCIL COMMENTS:

ADJOURNMENT:

Please note that this Agenda may be changed up to 24 hours before the meeting time as provided by Section 21.4(2), *Code of Iowa*.

MINUTES OF THE REGULAR MEETING OF THE AMES CITY COUNCIL

AMES, IOWA

AUGUST 13, 2019

The Regular Meeting of the Ames City Council was called to order by Mayor John Haila at 6:00 p.m. on August 13, 2019, in the City Council Chambers in City Hall, 515 Clark Avenue, pursuant to law. Present were Council Members, Amber Corrieri, Gloria Betcher, Tim Gartin, David Martin, and Chris Nelson. Council Member Bronwyn Beatty-Hansen was absent. *Ex officio* Devyn Leeson was also in attendance.

CONSENT AGENDA: Council Member Betcher requested to pull Item No. 14d: Renewal of Liquor License for Es Tas Stanton, 216 Stanton, for further discussion. Mayor Haila pulled for separate discussion, Item No. 15, Resolution approving Official Statement for General Obligation Corporate Purpose Bonds, Series 2019A, setting the date of sale for August 27, 2019, and authorizing electronic bidding for the sale.

Moved by Nelson, seconded by Gartin, to approve the following items on the Consent Agenda:

1. Motion approving payment of claims
2. Motion approving Minutes of Special Meetings held July 16, 2019, and August 2, 2019, and Regular Meeting held July 23, 2019
3. Motion approving Report of Change Orders for July 16 - 31, 2019
4. Motion approving new 5-day Class B Beer License (August 28, 2019 - September 2, 2019) - The Whimsical Wine Trailer, 1407 University Boulevard
5. Motion approving new 5-day Class B Beer License (September 25 - 29, 2019) - The Whimsical Wine Trailer, 1407 University Boulevard
6. Motion approving new 5-day Class B Beer License (October 30 - November 3, 2019) - The Whimsical Wine Trailer, 1407 University Boulevard
7. Motion approving new 5-day Special Class C Liquor License (August 22 - 26, 2019) - Gateway Market, ISU Alumni Center, pending satisfactory background checks
8. Motion approving new 12-month Class C Liquor License with Class B Wine and Sunday Sales- Hy-Vee Market Grille, 640 Lincoln Way
9. Motion approving Class A Liquor License Ownership Update - Green Hills Residents' Association, 2200 Hamilton Drive, Suite 100
10. Motion approving new 5-day Special Class C Liquor License (August 24 - 28, 2019) - Ames Historical Society, 416 Douglas Avenue, pending premise approval from Inspections and satisfactory background checks
11. Motion approving temporary Outdoor Service Privilege Update (September 13 - 14, 2019) for Special Class C Liquor License - Sips and Paddy's Irish Pub, 126 Welch Avenue
12. Motion approving temporary Outdoor Service Privilege Update (August 30 - 31, 2019) for Special Class C Liquor License - Sips and Paddy's Irish Pub, 126 Welch Avenue
13. Motion approving temporary Outdoor Service Privilege Update (September 15 - 16, 2019) for Special Class C Liquor License - Tip Top Lounge, 201 E Lincoln Way
14. Motion approving renewal of the following Beer Permits, Wine Permits, and Liquor Licenses:
 - a. Class C Liquor License with Catering, Class B Native Wine, Outdoor Service and Sunday

- Sales - The Mucky Duck Pub, 3100 S. Duff Avenue
- b. Class E Liquor License with Class B Wine, Class C Beer and Sunday Sales - Kum & Go # 1215, 4506 Lincoln Way
 - c. Class C Liquor License with Sunday Sales - El Azteca, 1520 S. Dayton Avenue
 - d. Class B Beer with Sunday Sales - Flame-N-Skewer, 2801 Grand Avenue, Ste. 1125
 - e. Class C Beer Permit with Class B Wine and Sunday Sales - Hy-Vee Gas #5013, 4018 West Lincoln Way
 - f. Class C Liquor License with Sunday Sales - Inside Golf, 2801 Grand Avenue, #1075
 - g. Class C Liquor License with Catering, Outdoor Service and Sunday Sales - Iowa State Center - CY Stephens, CY Stephens- Iowa State University
 - h. Class C Liquor License with Catering, Outdoor Service and Sunday Sales - Iowa State Center – Fisher, Fisher Theatre- Iowa State University
 - i. Class C Liquor License with Sunday Sales - JJC Ames 1 LLC, 2420 Lincoln Way, Suite 103
15. RESOLUTION NO. 19-390 approving Agreement with Iowa Department of Transportation for MPO/STBG-TAP grant funding for 2018/19 Shared Use Path System Expansion - Trail Connection south of Lincoln Way (Beedle Drive to Intermodal Facility)
 16. RESOLUTION NO. 19-391 approving Certificate of Consistency with City’s 2014-19 CDBG Consolidated Plan on behalf of the Emergency Residence Project
 17. RESOLUTION NO. 19-392 waiving Purchasing Policies and awarding a single-source contract with Donna Gilligan, Nevada, Iowa, in an amount not to exceed \$70,900 for FY 2019/20 for organizational development consulting services
 18. Edward Byrne Memorial Justice Assistance Grant:
 - a. RESOLUTION NO. 19-393 authorizing staff to apply for Grant
 - b. RESOLUTION NO. 19-394 approving Memorandum of Understanding with Story County
 - c. Motion authorizing Mayor to sign certification indicating that the City will abide by the Grant terms and conditions
 19. RESOLUTION NO. 19-395 approving Memorandum of Agreement and Agency Access Agreement with Story City Police Department allowing access to Multi-Agency Public Safety Network
 20. Requests from Ames Historical Society for “Uncorked” Exhibit Grand Opening on August 24:
 - a. RESOLUTION NO. 19-396 approving closure of four metered parking spaces in the 100 Block of 5th Street
 - b. RESOLUTION NO. 19-397 approving request for a waiver of fee for metered parking spaces
 - c. Motion approving Blanket Temporary Obstruction Permit
 - d. Motion approving Blanket Vending License
 - e. RESOLUTION NO. 19-398 approving request for a waiver of the fee for Vending License
 - f. RESOLUTION NO. 19-399 authorizing use of City-owned electrical outlets and approving a waiver of the fee for the cost of electricity used
 21. Requests from American Campus Communities for Campustown Fest on August 29:
 - a. Motion approving Blanket Temporary Obstruction Permit
 - b. RESOLUTION NO. 19-400 approving closure of Stanton Avenue from Chamberlain Street to driveway 230 feet south of the intersection
 - c. RESOLUTION NO. 19-401 approving closure of five metered parking spaces in the 200

block of Stanton

22. RESOLUTION NO. 19-402 awarding contract to Star Equipment of Ames, Iowa, for a combination unit for the Public Works Department in the amount of \$77,950 with applied credit of \$10,800 for rental charges, making the net purchasing price of \$67,150
23. RESOLUTION NO. 19-403 approving preliminary plans and specifications for 2018/19 Traffic Signal Program (U. S. Hwy. 30 Westbound Off-Ramp and South Dakota Avenue) setting September 4, 2019, as bid due date and September 10, 2019, as date of public hearing
24. RESOLUTION NO. 19-404 approving preliminary plans and specifications for 2019/20 Sanitary Sewer Rehabilitation (Munn Woods); setting September 18, 2019, as bid due date and September 24, 2019, as date of public hearing
25. RESOLUTION NO. 19-405 approving preliminary plans and specifications for 2018/19 Sanitary Sewer Rehabilitation (Siphon); setting September 18, 2019, as bid due date and September 24, 2019, as date of public hearing
26. RESOLUTION NO. 19-406 approving contract and bond for Non-Asbestos Insulation and Related Services & Supplies
27. RESOLUTION NO. 19-407 approving Contract Change Order No. 1 with GE Steam Power, Inc., of Windsor, Connecticut, for ash grate parts needed for Unit 7 Boiler project in the amount of \$5,011.02 inclusive of sales tax
28. Water Treatment Plant Lime Sludge Disposal Operation:
 - a. RESOLUTION NO. 19-408 approving Change Order No. 1 to FY 2018/19 contract with Wulfekuhle Injection & Pumping, Inc., the deduct amount of \$128,793.30
 - b. RESOLUTION NO. 19-409 accepting completion of FY 2018/19 contract with Wulfekuhle Injection and Pumping, Inc., in the final adjusted amount of \$253,106.70 and releasing retainage
 - c. RESOLUTION NO. 19-410 authorizing carry-over of unspent funds in the amount of \$128,793.30 from 2018/19 Operating Budget to FY 2019/20
 - d. RESOLUTION NO. 19-411 awarding contract to Wulfekuhle Injection and Pumping, Inc., of New Vienna, Iowa, for Year Two (FY 2019/20) in the amount of \$510,693.30
29. RESOLUTION NO. 19-412 approving Change Order to Professional Services Agreement with Strand Associates, Inc., to add bidding and construction phase services for Water Pollution Control Facility Methane Engine Generator Replacement Project in an amount not to exceed \$89,200
30. RESOLUTION NO. 19-413 accepting partial completion of public improvements and reducing security for Quarry Estates, 2nd Addition
31. 2016/17 Storm Water Erosion Control Program (S. Skunk River - Carr Park to Homewood Golf Course) Contract B:
 - a. RESOLUTION NO. 19-414 approving Change Order No. 1 with GreenTech of Iowa, LLC., of Grimes, Iowa
 - b. RESOLUTION NO. 19-415 accepting completion of project in the amount of \$57,381
32. Underground Trenching Services: FY 2014/15 through FY 2018/19:
 - a. RESOLUTION NO. 19-416 accepting completion of primary contract with Ames Trenching & Excavating, Inc., of Ames, Iowa, in the total amount of \$669,729.19
 - b. RESOLUTION NO. 19-417 accepting completion of secondary contract with

Communication Data Link, LLC, of Grimes, Iowa, in the total amount of \$243,017.30
Roll Call Vote: 5-0. Resolutions/Motions declared adopted/approved unanimously, signed by the Mayor, and hereby made a portion of these Minutes.

RENEWAL OF LIQUOR LICENSE FOR ES TAS STATION, 216 STANTON: Council Member Betcher explained that she had pulled this item because, in the past when discussing liquor licenses, the Council had issued six-month licenses instead of for a full year. She mentioned that Es Tas did not have any issues, but she was wondering how to get Es Tas employees to go to training when they haven't been to one in a year and a half. Police Chief Cychosz explained that the Police Department had communicated to Es Tas the expectations regarding attendance when going over the review process. He noted that since this item was pulled for discussion, it gives the Police Department another mechanism to use to point out to Es Tas the vulnerability of its liquor license if there are violations in combination with lack of attendance.

Moved by Betcher, seconded by Nelson, to approve the Liquor License with Sunday Sales for Es Tas Stanton, 216 Stanton.

Vote on Motion: 5-0. Motion declared carried unanimously.

OFFICIAL STATEMENT FOR GENERAL OBLIGATION CORPORATE PURPOSE BONDS, SERIES 2019A: Finance Director Duane Pitcher stated that he had requested to have this item pulled for a separate vote. He noted this is a bond issue that the Council has seen several times before during the bond process. Director Pitcher explained that no information has been withheld and they have followed all the required practices of the Municipal Securities Rule Making Board, which will include placing the report on its website.

Director Pitcher stated that they are ready for the date of sale on August 27, 2019. A rating call was held with Moody's and the City's rating will be announced next Thursday.

Moved by Betcher, seconded by Gartin, to approve RESOLUTION NO. 19-389 approving the Official Statement for General Obligation Corporate Purpose Bonds, Series 2019A, setting the date of sale for August 27, 2019, and authorizing electronic bidding for the sale.

Roll Call Vote: 5-0. Resolution declared adopted unanimously, signed by the Mayor, and hereby made a portion of these Minutes.

PUBLIC FORUM: Roman Lynch, 3720 Jewell Drive, Ames, explained he had been the Director of Midnight Madness for 33 years and wanted to thank the City of Ames for all the help throughout the years. He explained that they have provided a quality event for over 50,000 people where they have guarded intersections, had a party every year with no issues, put up a double fence with few complaints, and given thousands a chance to achieve goals. Mr. Lynch stated that he has appreciated working with different City departments throughout the years and appreciated everyone's help.

Mayor Haila stated that on behalf of the Council members they want to thank Mr. Lynch for spending the last

33 years spearheading the Midnight Madness event.

Bernard Dutchik, 101 3rd Avenue SW, Cedar Rapids, explained that he is with Imon Communications, which is a fiber-to-the-premises provider in Cedar Rapids, Dubuque, Iowa Falls, and other smaller communities throughout Iowa. Mr. Dutchik commented that he wanted to speak today to correct some misrepresentation regarding their interest in providing retail services to the Ames community. He explained that they are very interested in providing service to Ames and noted that if Ames was to do a public option, Imon would be happy to work with the City of Ames in that capacity as well. Mr. Dutchik stated they would be flexible in providing retail service or support a public option as well.

HEALTHY LIFE CENTER: City Manager Steve Schainker stated, as they get ready for the bond referendum on September 10, 2019, there was some work that needed to be done to make sure the necessary agreements were secure with Mary Greeley Medical Center (MGMC), Story County, Heartland Senior Services, and Iowa State University for the lease of the site. Mr. Schainker then briefly summarized some of the major aspects of each agreement. He did note that each agreement had been signed except for the Lease Agreement with Iowa State University; the Board of Regents has approved the document, but would like the City of Ames to sign it first.

Mayor Haila opened public comment and closed it after seeing no one come forward.

Moved by Nelson, seconded by Gartin, to adopt RESOLUTION NO. 19-418 approving the Memorandum of Understanding between the City of Ames and Mary Greeley Medical Center.
Roll Call Vote: 5-0. Resolution declared adopted unanimously, signed by the Mayor, and hereby made a portion of these Minutes.

Moved by Betcher, seconded by Gartin, to adopt RESOLUTION NO. 19-419 approving the Memorandum of Understanding between the City of Ames and Story County.
Roll Call Vote: 5-0. Resolution declared adopted unanimously, signed by the Mayor, and hereby made a portion of these Minutes.

Moved by Gartin, seconded by Betcher, to adopt RESOLUTION NO. 19-420 approving the Memorandum of Understanding between the City of Ames and Heartland Senior Services.
Roll Call Vote: 5-0. Resolution declared adopted unanimously, signed by the Mayor, and hereby made a portion of these Minutes.

Moved by Betcher, seconded by Martin, to adopt RESOLUTION NO. 19-421 approving the Lease Agreement between the City of Ames and Iowa State University.
Roll Call Vote: 5-0. Resolution declared adopted unanimously, signed by the Mayor, and hereby made a portion of these Minutes.

Moved by Martin, seconded by Corrieri, to ask staff to draft a Resolution for Council in support of the Healthy Life Center.

Vote on Motion: 5-0. Motion declared carried unanimously.

PRESENTATION FROM METRONET REGARDING FIBER-TO-THE-PREMISES INTERNET SERVICE: Mayor Haila notified the public that no public comment would be taken at this time, as the presentation is for informational purposes only. If the public is interested in speaking with representatives from MetroNet, they will be available in the lobby after their presentation.

Assistant City Manager Brian Phillips explained that, at the June 25, 2019, City Council meeting, City staff provided a follow-up report regarding internet service in the community. At that meeting, staff reported that a provider had approached the City with interest in providing privately operated fiber-to-the-premises service in Ames. The City Council directed staff to have MetroNet present its plans regarding the Council's interest in speed, availability, reliability, customer service, cost, and net neutrality. Mr. Phillips stated no action is needed for this item by City Council.

Kathy Scheller, Government Affairs Director for MetroNet stated that she and her colleague Keith Leonhardt, Vice President of Communications and Market' Development, were at the City Council meeting to introduce the Council to MetroNet, a fiber-to-the-premises provider. Ms. Scheller explained that their company will be bringing a \$20 million investment to the City of Ames and will be able to show an impact to the residents.

MetroNet is a 100% fiber-optic internet, television, and phone company established in 2004 that serves over 80 communities in seven states and has over 112,000 subscribers. They offer blazing-fast symmetrical internet service. Ms. Scheller noted that part of their corporate culture is their passion for Customer Service. She explained that a true fiber-optic-to-the-premises connection gives reliably-fast broadband, simultaneous streaming, distance learning, tele-commuting, and more. Other benefits of fiber-optics-to-the-premises are increases in home value of approximately 3.1%, exclusive access, competition, better customer service, and competitive pricing.

Ms. Scheller commented that the City of Ames will see the following benefits:

- High Level of Customer Service - An average of 30% higher customer satisfaction scores than peers. Eight different scores are measured monthly.
- Broad Availability
- Local Presence - local retail stores, local staff, community involvement, and local events
- Superior Fiber Services - 1 gigabit symmetrical speeds, no long-term contracts, best technology, attractive "more for the same" pricing, pass-thru video pricing, redundancy route, and outage communication plan.

Ms. Scheller explained that when MetroNet comes in to build new infrastructure, it wants the residents to understand the full process. When building new infrastructure, it has the following neighborhood communication plan:

- Construction Communications - Letters, postcards, turf signs, entrance signs, etc.
- Construction Website - Document questions or concerns, yard restoration, locate underground

utilities, etc.

- Responsiveness - 95% response rate within 24 hours to problems

Mr. Leonhardt stated that their objective is to not create any chaos as the neighborhoods are notified several times that the company will be in their area doing construction work. He noted that they will work with the City by giving reports regarding their actions, as this helps hold them accountable, in responding to the residents. Ms. Scheller explained that prior to construction they go to the City to get direction from leadership as to who will be answering the phone and other ways they can educate the public.

Ms. Scheller appreciates the Council looking at a fiber-optic service and MetroNet is already in Bettendorf and Davenport. They are excited about the opportunity to have service within the City of Ames. Dan Casciato, Governmental Affairs Manager, was introduced as the MetroNet representative who will be in the City of Ames during construction.

Council Member Nelson inquired if MetroNet rates differentiate between commercial and residential customers. Ms. Scheller explained that they do have a business and commercial team that will closely work with businesses for the best option, and they also have a team that is for school and government entities.

Mayor Haila asked if Ms. Scheller could better explain what the citizens might expect their yard to look like during construction. Ms. Scheller stated that, before they go into a neighborhood, they will have a pre-construction meeting for that neighborhood with City officials, any utilities already present, and MetroNet engineers. She explained that they follow the power, if above will follow the power line, and if underground, they will bore and the areas will be dug up and restore the properties as they go along. Mr. Leonhardt explained that they do have two videos on their website showing some of the construction processes, and if during restoration the customer is not happy, they will come back and do more restoration.

Council Member Gartin commented that the Council had received about 25-30 emails from citizens who have expressed interest in the Council pursuing a program for a utility that would provide internet service on a community basis. The primary reason the citizens are wanting this is to provide 100% coverage in the City of Ames. He wondered if MetroNet can provide this coverage. Ms. Scheller stated that this is a common question; and there will be some pocket areas that are not dense enough for MetroNet to provide service during the initial build-out, however, the company is open to discussions to try and come up with solutions to those areas. Mr. Gartin inquired what the highest level of coverage in a community that MetroNet covers. Ms. Scheller stated she is not sure, but can obtain that information and provide it to Assistant City Manager Brian Phillips.

Mr. Gartin asked if there was a time frame that MetroNet is looking to come to Ames. Ms. Scheller stated that this spring they will be in the area to set-up and to start installing. The construction process will take about two years.

Council Member Betcher stated she wanted to go back to the issue of coverage as her ward has older neighborhoods, and she is concerned that coverage would not be available. Ms. Scheller stated that this had happened in Bloomington. Its Council had given MetroNet the opportunity to put in their own temporary poles until new poles could be installed by the city.

Council Member Martin asked if there are any maps available showing where MetroNet will be building out. Ms. Scheller stated they have started on a design for the City of Ames, but nothing is ready yet. Mr. Leonhardt explained that this map will be shown on their website so everyone can see where service will be available. The maps will be available around the same time MetroNet starts to dig.

Mr. Martin asked for a time frame of when a local office will be set-up. Mr. Leonhardt mentioned that a local office is usually up and operating a month before services are available.

Mr. Martin explained that MetroNet is offering a very fast service and inquired what MetroNet does to make sure they have the back-end capacity to serve all the customers. Mr. Leonhardt stated that is a question for one of their engineers, but did state that fiber optic provides incredible bandwidth that doesn't cause the upstream/downstream that a person would get with copper systems.

Further discussions were had regarding what MetroNet can offer.

STAFF REPORT REGARDING OUTSIDE FUNDING REQUEST PROCESS PRIORITIES:

Assistant City Manager Brian Phillips stated this is a follow-up from the budget wrap-up session in February 2019. He noted that the application period for funding requests will close in November so if the Council has any new priorities, those will be relayed to any perspective applicants.

Council Member Betcher asked if there were any challenges noted from the citizen committees regarding the general nature of the priorities. Mr. Phillips stated that they are no longer involving outside residents in the process. He stated they will probably have the same issues as they normally do as there will always be more interest and proposals than what is available for funding. Mr. Phillips stated that, in the past, they had asked the applicants to prioritize their own tasks in their preferred order.

Council Member Gartin commented that one of his concerns is that he doesn't want any organization to have a sense of entitlement; i.e., doesn't want an organization to think that the funds will come their way just because they have been awarded money in the past. Mr. Gartin commented that he appreciates the recommendation that regardless of the criteria, no requests are grandfathered.

Mayor Haila noted that there are four items that were approved a few years ago and asked the Council if they wanted to make any changes. Council Member Betcher mentioned that it is hard to quantify broad-based appeal and wanted to know if this means it is a representation from a number of groups or the number of people involved. Mr. Phillips stated he is not sure he can point to a specific application, but it was something that was important to the Council when it was established.

Ms. Betcher stated they get a lot of different applications that either have very little or a lot of data. She wanted to know if there was a way to have the process run a little bit smoother and would like to have more data for each request be required. Mr. Phillips stated that if the Council wanted to incorporate that into the application process, that could be done.

Council Member Amber Corrieri mentioned that she would recommend keeping the four bulleted items but put them in an order of priority. It was suggested that the four items be listed as:

1. A program or activity that would otherwise be operated by the City at a greater cost
2. Requests that have broad-based appeal to the community
3. Requests that provide a unique benefit or service to the community
4. Requests that pursue current City Council goals (www.cityofames.org/goals)

Moved by Corrieri, seconded by Betcher, to have staff leave the four bulleted criteria in place, but have them ordered sequentially by priority and to have number two read as “requests that have broad-based appeal to the community demonstrated by the number of participants” or something similar as staff can work on the wording.

Vote on Motion: 4-1 Voting aye: Betcher, Gartin, Nelson, Corrieri. Voting nay: Martin. Motion declared carried.

Moved by Gartin, seconded by Martin, to adopt Item 3, “Regardless of the criteria, no requests are grandfathered” in the instructions and criteria.

Vote on Motion: 5-0. Motion declared carried unanimously.

Further discussion ensued regarding previous years’ requests.

STAFF REPORT REGARDING REGULATION OF MASSAGE ESTABLISHMENTS:

Assistant City Manager Brian Phillips recalled that a workshop on this topic was held on April 16, 2019, and City Council had directed staff to bring back possibilities for an ordinance that would regulate massage establishments within Ames as well as further decision points along the lines of the City of Des Moines ordinance. Staff was also tasked with adding provisions to hold owners and managers responsible and measures to assist staff during an investigation when warranted. Mr. Phillips explained that staff is recommending an ordinance be drafted using the Des Moines ordinance as a model and include requirements similar to Davenport/Iowa City related to providing information pertaining to the business and its employees upon demand by City staff and a requirement to designate a manager, in writing, who will be responsible for compliance and for providing information as required in the ordinance.

Council Member Betcher inquired if the manager would need to be located within the City of Ames or if they could be located elsewhere. Mr. Phillips stated he is not sure if the other ordinances specified if the manager had to be local, but that is something that could be written into the City of Ames ordinance.

Mayor Haila wanted to know if it would be possible if there was a business with multiple therapists

for the therapists to display their license and a picture of them on the wall in the main office and also in the therapy room. He asked if this would be beneficial to the customer and the Police Department.

Police Chief Chuck Cychosz explained that the Police department would like the ordinance to give them the ability to go into a business and be able to match up the licenses with the therapists. He noted that the key would be the designation of a manager to help discuss the everyday practices of the business. Chief Cychosz also mentioned that to have the license and picture available would help make the customers feel more comfortable as well.

Mayor Haila noted that he had heard from one person who rents a room in a business and is a licensed massage therapist. He wondered if the therapist would be considered the manager. Chief Cychosz stated that some therapists will be a sole-proprietorship where they are the owner and the manager.

Mayor Haila stated that Davenport had added a reflexologist. He asked if that would be something that the City of Ames needs to add to the ordinance as well. Mr. Phillips stated he can look into the reflexology and see if they are exempt from licensing.

Council Member Martin wanted to know if the manager were unable to be located if the City would still be able to take action against the business. Chief Cychosz explained that is how they are envisioning the ordinance to read. The Police Department would be able to placard the business until the business is compliant.

Michelle DeMarie, 4933 Utah Drive, Ames, explained that she is a licensed massage therapist who operates out of her home. She had an opportunity to review the staff report and supports the staff's recommendation. She noted that Licensed Massage Therapists (LMTs) are already required to post their license in their office space; and if they are doing work outside of the office, they have to have a wallet-size card showing they are a LMT. Ms. DeMarie mentioned that she feels it is a loophole at the state level that the LMTs have to take a test to pass to get their license, but there is no background check done and no photo identification on file. She inquired if the recommendation to draft an ordinance was passed tonight, when the estimated time would be for an ordinance when come back to the Council for approval. City Attorney Mark Lambert stated that it would be two to four weeks and then it will have to go through first, second, and third readings. Mayor Haila asked Ms. DeMarie if she would be supportive if the ordinance asked for a photo to be displayed. Ms. DeMarie commented that she would not have a problem at all and felt that might be helpful to the customers as well.

George Belitsos, 5508 West Lincoln Way, Ames, mentioned that he is representing the Iowa Network Against Human Trafficking, of which he is the Chair of the Board of Directors. He stated this day has been a long day coming; they have been working for the past two years to have something done. Dr. Belitsos commented that he has worked with other cities that have passed ordinances and has seen the good that has come of it. He mentioned that the City of Davenport had passed an ordinance, and within a week of the ordinance being in effect, five businesses were closed,

five women were saved, and two traffickers were arrested. Dr. Belitsos stated they are in support of Alternative #1 and adding the section about keeping the managers accountable. He recommended that staff add that the manager must live in the state of Iowa and require that businesses not operate between the hours of midnight to 5 a.m. with an allowance for exceptions. He noted that the City of Ames is one of the first cities to provide training for hotel/motel employees; this is now being done in several cities throughout Iowa.

Council Member Betcher mentioned that she thought the Council had received feedback from someone that does massages for shift workers that are off work from midnight to 5 a.m. Ms. DeMarie believed that was mentioned by another LMT that is employed by Mary Greeley Medical Center and the service is provided at the hospital.

Moved by Nelson, seconded by Betcher, to direct staff to draft an ordinance using the Des Moines ordinance as a model and 1) include requirements similar to Davenport/Iowa City related to providing information about the business and its employees upon demand by City staff, 2) include requirements to designate a manager, in writing, who will be responsible for compliance and for providing information as required in the ordinance, 3) the manager must be a resident of Iowa and shall consent to serve as an agent for services of notices relating to the business, 4) to have staff add language to the ordinance to prohibit services from midnight to 5 a.m., but with an exception process to be made by staff.

Vote on Motion: 5-0. Motion declared carried unanimously.

Moved by Martin, seconded by Betcher, to draft language into the ordinance to require having the LMT's photo on display in the waiting and therapy rooms at their primary place of business.

Vote on Motion: 5-0. Motion declared carried unanimously.

Mayor Haila stated that he is going to move Item 38 and 40 until the end of the Agenda (before the Closed Session). Those two items will be discussed if time allows.

INCLUSIVE CROSSWALK AT 5TH STREET AND DOUGLAS AVENUE: Public Works Director John Joiner stated that at the June 25, 2019, City Council meeting, Council had directed staff to proceed with a project to install an inclusive crosswalk treatment at the 5th Street and Douglas Avenue intersection in Downtown Ames. It was the Council's intent to complete the installation prior to Pridefest on Saturday, September 7th. However, approximately one week following the City Council meeting, the staff from the local Federal Highway Administration (FHWA) had notified City staff that they were reviewing the proposed design for compliance with the Manual on Uniform Traffic Control Devices (MUTCD). In an email dated July 16, 2019, the FHWA determined that the proposed inclusive crosswalk design was non-compliant, and that if the City installed the treatment, FHWA would issue an official letter of non-compliance. Director Joiner also noted that because it is in the height of the construction season and the project has a relatively short deadline, the City only received one quote for \$68,760, which is approximately \$56,000 greater than the amount originally quoted to the City Council. He explained that staff reached out to the City Attorney, and his opinion was that a letter of non-compliance from the FHWA does not, in and of itself, increase

the City's liability.

Mr. Joiner briefly explained the five alternatives available to the Council.

Moved by Gartin, seconded by Corrieri, to direct staff to install the decorative crosswalk bars with non-specialty paint using City staff labor prior to 2019 Pridefest with an estimated cost of \$4,000. Vote on Motion: 5-0. Motion declared carried unanimously.

Moved by Martin, seconded by Corrieri, to direct staff to rebid the thermoplastic installation over the winter of 2019/20 for contractor installation prior to Pridefest 2020.

Council Member Betcher mentioned that she is interested in possible other funding options by working with other local community groups.

Vote on Motion: 5-0. Motion declared carried unanimously.

ALCOHOL SERVICE AT SIDEWALK CAFÉ AT MOTHER'S PUB, 2900 WEST STREET: Assistant City Manager Brian Phillips explained that this item is a request for an exception to the sidewalk café ordinance. He noted that the Council has approved an exception for this establishment in the past. Staff has reviewed the application and compliance history and is comfortable approving the exception for this sidewalk café season only.

Public comment was opened by Mayor Haila and then closed when no one came forward to speak.

Moved by Nelson, seconded by Corrieri, to approve RESOLUTION NO. 19-422 approving the request from Mother's Pub for an Outdoor Service Privilege and a waiver to allow alcohol service at its sidewalk café during the 2019 Sidewalk Café season.

Roll Call Vote: 5-0: Resolution declared adopted unanimously, signed by the Mayor, and hereby made a portion of these Minutes.

Mayor Haila declared a recess at 8:01 p.m. The meeting reconvened at 8:07 p.m.

RENTAL HOUSING CODE CHANGES: Building Official Sara Van Meeteran explained that, on July 23, 2019, the Council voted on the Rental Code to add three options to put into a draft ordinance.

Council Member Martin explained that his motion regarding the one-year letter of compliance revocation was to be put it in the tool-box, rather than require a one-year revocation. Mr. Martin stated that the drafted ordinance reads like it is a requirement, but he would like to leave it up to staff discretion.

Moved by Martin, seconded by Betcher, to give staff discretion on whether to apply the penalty or not.

Motion withdrawn.

Moved by Martin, seconded by Betcher, to revise the wording under Section 13.301: Letter of Compliance (LOC), in the italicized paragraph, to change the word “are” to “may be.”

Vote on Motion: 5-0. Motion declared carried unanimously.

Moved by Betcher, seconded by Corrieri, to approve the draft ordinance as amended and move it forward for public comment.

Vote on Motion: 5-0. Motion declared carried unanimously.

PURCHASE OF 1417 DOUGLAS AVENUE AND ALLOCATE FUNDS FOR ASBESTOS REMOVAL AND DEMOLITION IN CONJUNCTION WITH THE CITY’S DANGEROUS BUILDINGS PROGRAM: Housing Coordinator Vanessa Baker-Latimer explained that as part of the City’s Dangerous Building Code (Chapter (5.401) of the *Ames Municipal Code*), the property at 1417 Douglas Avenue owned by Phyllis Range was declared a dangerous structure on May 7, 2019. This decision was upheld by the Board of Appeals at its June 3, 2019, meeting and was authorized to be demolished. Ms. Baker-Latimer noted that it would be advantageous for the City to buy the property, tear it down, and then resell the lot in the hope to recoup some of the funds. The property owner is willing to sell the property for \$11,532, but after deductions the property owner would net approximately \$8,000.

Mayor Haila opened public comment. No one came forward to speak, and he closed public comment.

Moved by Corrieri, seconded by Gartin, to approve RESOLUTION NO. 19-423 approving borrowing approximately \$11,532 from the City-wide Affordable Housing Fund for the purchase of the property and approximately \$45,000 for asbestos removal and demolition of the structure at 1417 Douglas Avenue and approve the re-selling of the lot with the proceeds used to reimburse that fund. Roll Call Vote: 5-0: Resolution declared adopted unanimously, signed by the Mayor, and hereby made a portion of these Minutes.

HEARING ON VACATION OF PUBLIC UTILITY, SURFACE WATER FLOWAGE, AND STORM SEWER EASEMENTS AT 397 WILDER AVENUE (CONTINUED FROM JULY 23, 2019): The public hearing was continued from the City Council meeting on July 23, 2019. The Mayor opened and closed public comment since there was no one wishing to speak.

Moved by Betcher, seconded by Corrieri, to adopt RESOLUTION NO. 19-424 approving the vacation of Public Utility, Surface Water Flowage, and Storm Sewer Easements at 397 Wilder Avenue.

Roll Call Vote: 5-0: Resolution declared adopted unanimously, signed by the Mayor, and hereby made a portion of these Minutes.

Moved by Betcher, seconded by Corrieri, to adopt RESOLUTION NO. 19-425 accepting the donation of Parcel A (1.2 acres) from the Sunset Ridge Property Owners’ Association for future park

land, contingent upon receiving a 10' public utility easement along the east edge of Parcel A and surface flowage and storm sewer easements over the northeast corner of Parcel A.

Roll Call Vote: 5-0: Resolution declared adopted unanimously, signed by the Mayor, and hereby made a portion of these Minutes.

HEARING ON 2019-2023 CONSOLIDATED PLAN AND 2019-2020 ANNUAL ACTION PLAN: City of Ames Housing Coordinator Vanessa Baker-Latimer advised that the 2019-2023 Five-Year Consolidated Plan includes HOME funds. Goals for the 2019-2023 Five-Year Plan will be:

1. To create and expand affordable housing for low-income households through:
 - Increase supply of single-family or two-family housing for ownership in the Neighborhood Revitalization Strategy Area (NRSA)
 - Reduce the cost burden for low-income households to access or maintain rental housing city-wide
 - Increase the affordability and availability of owner housing for homebuyers city-wide

Ms. Baker-Latimer stated that the Council always has the option to update the goals with Housing and Urban Development (HUD). The Council would just need to go through another public comment process.

Housing Coordinator Baker-Latimer explained that the proposed 2019-2020 Annual Action Plan projects include the following:

- Homebuyer Assistance Program - over \$300,000 was set aside
- Public Infrastructure Improvements Program - roll-over money from 2018-2019 plus a 2019 allocation of approximately \$600,000 and GO Bond roll-over money of about \$250,000 to finish the 321 State Avenue site
- Rehabilitation/Resale of 241 Village Drive - funds in the amount of \$45,000 have been set aside to rehabilitate/resell to low-income first time homebuyer
- Acquisition/Reuse Affordable Housing Program - \$400,000 has been set aside to purchase property for conversion to single-home ownership and resale to low-income homebuyer

HOME money in 2019-2020 in the amount of \$883,976 has been set aside for new home construction at 321 State Avenue.

Ms. Baker-Latimer brought the Council's attention to two comments that she had received during the comment period. The first comment was regarding a residential area on the northeast corner of Hickory and McDonald Drive. Ms. Baker-Latimer explained that she had misunderstood the comment to be that of infrastructure improvements rather than residential properties and she sent an email to clarify what specific property address they were referring to so she could respond accordingly. In regards to residential properties, in the 2019-2020 CDBG Acquisition/Reuse Program funds have been set aside to address vacant, abandoned, or deteriorated housing units to convert them back to single-family home ownership. In the Plan it has been stipulated that this could be implemented on a city-wide basis, rather than just in the Neighborhood Revitalization Strategy Area.

First, it would need to be determined if any of the properties being referred to would be eligible for purchase. Some of the determining factors would include: 1) meeting environmental requirements, 2) if the properties are vacant or occupied, 3) if there is a willing seller, and 4) if this would be a priority area for City Council. She also noted that the 2019-2020 HOME funds have been designated for affordable housing at the 321 State Avenue site.

The second comment was received from the AMOS organization. It was regarding utilizing CDBG or HOME funding for a Housing First/Permanent Support Housing Program for the chronically homeless and the chronically homeless experiencing mental illness in Ames. She noted that she had been researching this program and HUD's funding for the Housing First philosophy and Permanent Support Housing Program is directly required for homeless shelter providers as part of the Continuum of Care (CoC) and the Emergency Solutions Grant (ESG) Programs. The City of Ames does not receive funding from either of those programs. The funding of those programs is administered by the Iowa Finance Authority (IFA) for agencies in Ames/Story County. The City of Ames does, however, as part of the Consolidated Plan provide a letter of support to IFA for three agencies (ACCESS, ERP, and YSS) that apply for those funds on an annual basis. She explained that in speaking with the AMOS representative, they are aware of the extensive research that needs to take place to determine what the need would be for a Housing First/Permanent Support Housing Program in Ames. AMOS did want the Council to be aware that they will be moving forward on this for the future.

The public hearing was opened and then closed by Mayor Haila when no one came forward to speak.

Moved by Gartin, seconded by Betcher, to adopt RESOLUTION NO. 19-426 approving the submittal of the 2019-2023 Consolidated Plan, 2019 Fair Housing Impediments Study, and the 2019 Update to the Citizen Participation Plan.

Roll Call Vote: 5-0: Resolution declared adopted unanimously, signed by the Mayor, and hereby made a portion of these Minutes.

Moved by Betcher, seconded by Martin, to adopt RESOLUTION NO. 19-427 the submittal of the documents pertaining to the 2019-2020 Annual Action Plan.

Roll Call Vote: 5-0: Resolution declared adopted unanimously, signed by the Mayor, and hereby made a portion of these Minutes.

HEARING ON WATER TREATMENT PLANT HANDRAIL MODIFICATIONS PROJECT:

The Mayor opened the public hearing and closed it after there was no one wishing to speak.

Moved by Betcher, seconded by Nelson, to accept the report of bids and reject all bids.

Vote on Motion: 5-0. Motion declared carried unanimously.

HEARING ON WELLHEAD CONTROLS IMPROVEMENTS & REPAINTING PROJECT:

The Mayor opened the public hearing and closed it after no one came forward to speak.

Moved by Gartin, seconded by Betcher, to adopt RESOLUTION NO. 19-428 approving the plans and specifications and awarding a contract to Baker Electric from Des Moines, Iowa, in the amount of \$287,000.

Roll Call Vote: 5-0: Resolution declared adopted unanimously, signed by the Mayor, and hereby made a portion of these Minutes.

HEARING ON 2017/18 WATER SYSTEM IMPROVEMENTS PROGRAM #1 - WATER SYSTEM TRANSFERS (10TH STREET, 12TH STREET, GRAY AVENUE, COUNTRY CLUB BOULEVARD, AND CESSNA STREET): The Mayor opened the public hearing and closed it after there was no one wishing to speak.

Moved by Betcher, seconded by Martin, to adopt RESOLUTION NO. 19-429 approving the plans and specifications and awarding a contract to Ames Trenching & Excavating, of Ames, Iowa, in the amount of \$320,456.

Roll Call Vote: 5-0: Resolution declared adopted unanimously, signed by the Mayor, and hereby made a portion of these Minutes.

HEARING ON 2017/18 SHARED USE PATH SYSTEM EXPANSION (WEST LINCOLN WAY - SUNSET RIDGE SUBDIVISION TO NORTH DAKOTA AVENUE): The public hearing was opened by the Mayor. He closed the hearing after no one asked to speak.

Moved by Martin, seconded by Betcher, to adopt RESOLUTION NO. 19-430 approving the plans and specifications and awarding a contract to Manatt's Inc., of Ames, Iowa, in the amount of \$193,618.93.

Roll Call Vote: 5-0: Resolution declared adopted unanimously, signed by the Mayor, and hereby made a portion of these Minutes.

HEARING ON STORM WATER FACILITY REHAB (SOMERSET SUBDIVISION POND IMPROVEMENTS): The Mayor opened the public hearing and closed it after there was no one wishing to speak.

Moved by Betcher, seconded by Martin, to adopt RESOLUTION NO. 19-431 approving the plans and specifications and awarding a contract to Con-Struct, Inc., of Ames, Iowa, in the amount of \$322,997.

Roll Call Vote: 5-0: Resolution declared adopted unanimously, signed by the Mayor, and hereby made a portion of these Minutes.

HEARING ON 2018/19 WATER SYSTEM IMPROVEMENTS (BURNETT AVENUE, MURRAY DRIVE):The public hearing was opened by the Mayor. He closed the hearing after no one came forward to speak.

Moved by Betcher, seconded by Nelson, to adopt RESOLUTION NO. 19-432 approving the plans and specifications and awarding a contract to Keller Excavating Inc., of Boone, Iowa, in the amount

of \$1,194,492.10.

Roll Call Vote: 5-0: Resolution declared adopted unanimously, signed by the Mayor, and hereby made a portion of these Minutes.

ORDINANCE TO ALLOW MULTIPLE BUILDINGS ON SINGLE LOTS IN CERTAIN ZONING DISTRICTS: City Attorney Mark Lambert explained that on the first reading, the Council had adopted an Amendment to add the Hospital-Medical Zone, but then the at second reading, that wording was not in the ordinance as Planning staff decided there was not a need for that Amendment. The ordinance passed on second reading without rescinding the Amendment. Attorney Lambert mentioned that a motion to strike any reference to the Hospital-Medical Zone from the ordinance will be needed tonight and then the Council will be able to approve it on third reading and adopt it.

Moved by Nelson, seconded by Betcher, to amend the ordinance to delete the reference to Hospital-Medical Zone.

Roll Call Vote: 5-0: Motion declared adopted unanimously.

Moved by Nelson, seconded by Betcher, to adopt the revised ORDINANCE NO. 4390 amending Chapter 29.401(5) to allow multiple buildings on single lots in certain zoning districts.

Roll Call Vote: 5-0. Ordinance declared adopted unanimously, signed by the Mayor, and hereby made a portion of these Minutes.

PARKING METER WAIVERS: Mayor Haila asked the Council if it would like to discuss this item or move it to another agenda as it is not time-sensitive.

Council Member Corrieri commented that she would be in favor of waiting to discuss this item until after the parking study is complete.

Council Member Gartin asked if the parking study would give the Council members information that would help them with the policy change and infrastructure. City Manager Steve Schainker stated that it is not directly geared towards that, but may indirectly help.

Council Member Martin noted that the Council will still continue to get requests for parking meter waivers that will have to be reviewed on a case-by-case basis.

Moved by Corrieri, seconded by Betcher, to hold off on discussing the Parking Meter Waivers issue until the Council has received the parking study.

Vote on Motion: 5-0. Motion declared carried unanimously.

COLLABORATION WITH IOWA STATE UNIVERSITY'S PRINCIPLES OF COMMUNITY CAMPAIGN: Mayor Haila asked if the City Council would like to discuss this item tonight or move to a future agenda.

Council Member Gartin wanted to know if this was a topic that Council Member Bronwyn Beatty-Hansen should be in attendance for. Mayor Haila stated it would be preferable to have a full Council when discussing this item as Council Member Betcher did email more information to Council for review.

Moved by Corrieri, seconded by Betcher, to hold off discussion of this item at a future meeting to be determined by staff.

Vote on Motion: 5-0. Motion declared carried unanimously.

CLOSED SESSION: Council Member Gartin asked City Attorney Mark Lambert if there was a legal reason to go into Closed Session. Mr. Lambert replied in the affirmative, citing *Code of Iowa* Section 21.5(1)(k) to discuss security-related plans or reports.

Moved by Gartin, seconded by Corrieri, to go into Closed Session under Section 21.5(1)(k), *Code of Iowa*, to discuss security-related plans or reports.

Roll Call Vote: 5-0. Motion declared carried unanimously.

The Council went into Closed Session at 8:42 p.m. and returned to Regular Session at 9:06 p.m.

Moved by Gartin, seconded by Betcher, to adopt RESOLUTION NO. 19-433 approving the Story County Courthouse Security Plan.

Roll Call Vote: 5-0. Resolution declared adopted unanimously, signed by the Mayor, and hereby made a portion of these Minutes.

Moved by Gartin, seconded by Betcher, to direct the City Attorney to pursue other options as discussed during the Closed Session.

Vote on Motion: 5-0. Motion declared carried unanimously.

DISPOSITION OF COMMUNICATIONS TO COUNCIL: Moved by Nelson, seconded by Betcher, to place the letter from Dan Culhane requesting the City of Ames to be a sponsor for the second annual Symposium on Building Inclusive Organizations on a future agenda.

Vote on Motion: 5-0. Motion declared carried unanimously.

Moved by Betcher, seconded by Corrieri, to get a memo from staff with more information to clarify what Rick Thompson is referring to in his email about storm water being pumped onto Mr. Flummerfelt's property.

Vote on Motion: 5-0. Motion declared carried unanimously.

Moved by Betcher, seconded by Nelson, to place the letter from Joel Hochstein, Chair of AHRC, on a future agenda for discussion.

Council Member Gartin stated this is a major intervention in the landlord/tenant relationship and he feels there is going to unintended consequences. Mayor Haila commented that this item will take

up a lot of time and asked the Council if it wants staff to spend the time to work on it. Ms. Betcher stated that she is not setting a time and thinks staff can decide when this item can go on an Agenda.

Vote on Motion: 4-1. Voting aye: Betcher, Martin, Nelson, Corrieri. Voting nay: Gartin. Motion declared carried.

COUNCIL COMMENTS: City Council Member Betcher stated that Rummage Ramage made \$33,000 and kept a lot of recoverable resources out of the waste stream. There were 22 non-profits that benefitted from this event.

Council Member Martin mentioned that he is excited about the Greenhouse Gas Inventory and has learned from staff that the Request for Proposals (RFPs) are out right now with a contract to be awarded in September or October.

Council Member Martin commented that MetroNet showed everyone that it is an interesting offer in addition to the options in Ames. He was impressed with its willingness to engage the community to minimize disruption and offer transparency. However, he noted that he doesn't think the Council can conclude that MetroNet will fix all the internet problems in Ames.

Moved by Martin, seconded by Betcher, to add the discussion of a feasibility study to an agenda in the future.

Council Member Gartin stated that would like the study to look at a city utility, but also options to what it would take to close the gap.

Vote on Motion: 5-0. Motion declared carried unanimously.

Council Member Martin stated that the Council received a brief email from a resident of Ames, on July 30, 2019, that asked for options for safe place to meet for purchases off of Craigslist or other applications. Other Council member stated that this has been discussed in the past, Assistant City Manager Brian Phillips stated that people are encouraged to use the City of Ames Parking Lot M. It was recommended that Council Member Martin send an email reply.

Council Member Martin explained that he is happy that the 2018/19 Traffic Signal Program (US Hwy 30 Westbound Off-Ramp and South Dakota Avenue) is coming up, but has heard from several people that the traffic backs up onto US Hwy. 30, and with the high speed of traffic, this can be dangerous.

Moved by Martin, seconded by Gartin, to ask staff for a memo on ideas for short-term ways to address the problem of traffic congestion on the westbound off-ramp of Hwy. 30 towards Mortensen Road.

Vote on Motion: 5-0. Motion declared carried unanimously.

Council Member Gartin stated that the Council had received an email from Dr. Robert Brown, Director of the Bioeconomy Institute at Iowa State University, asking the City for a letter of support for the use of bio-asphalt for paving bicycle paths. He noted that it does not require any financial support from the City just a letter of general support. The proposal is due September 15, 2019.

Moved by Gartin, seconded by Martin, to direct staff to work with Dr. Brown to provide a letter of support for the use of bio-asphalt for paving bicycle paths.

Vote on Motion: 5-0. Motion declared carried unanimously.

Council Member Gartin mentioned that he and Council Member Beatty-Hansen had met with Merry Rankin and several ISU faculty member to learn about carbon sequestration efforts. He would like to invite Merry Rankin to speak at a City Council meeting to discuss some items that have some merit for the Council to consider specific ways to partner with ISU in regards to carbon sequestration.

Moved by Gartin, seconded by Martin, to invite Merry Rankin to a City Council meeting to give a report on opportunities to partner with ISU regarding carbon sequestration efforts.

Vote on Motion: 5-0. Motion declared carried unanimously.

ADJOURNMENT: Moved by Gartin to adjourn the meeting at 9:23 p.m.

Amy L. Colwell, Deputy City Clerk

John A. Haila, Mayor



REPORT OF CONTRACT CHANGE ORDERS

Period:	<input checked="" type="checkbox"/>	1 st – 15 th
	<input type="checkbox"/>	16 th – End of Month
Month & Year:	August 2019	
For City Council Date:	August 27, 2019	

Department	General Description of Contract	Contract Change No.	Original Contract Amount	Contractor/ Vendor	Total of Prior Change Orders	Amount this Change Order	Change Approved By	Purchasing Contact (Buyer)
Public Works	2007/08 Shared Use Path (Bloomington Rd to Ada Hayden)	1	\$385,000.00	Elder Corporation	\$0.00	\$1,467.99	J. Joiner	MA
Public Works	2017/18 South Duff Ave Improvements	5	\$2,374,992.00	Con-Struct Inc.	\$-(17,356.04)	\$-(1,990.92)	J. Joiner	MA
Electric Services	Engineering Services for Top-O-Hollow Substation Improvements	4	\$264,791.00	DGR Engineering	\$106,500.00	\$24,000.00	B. Phillips	KS
Human Resources	Professional Services for ETP Expansion	3	\$42,950.00	Donna L. Gilligan	\$20,800.00	\$13,875.00	B. Jorgenson	KS
			\$		\$	\$		
			\$		\$	\$		

Applicant License Application (LC0039334)

Name of Applicant: <u>Texas Roadhouse Holdings LLC</u>		
Name of Business (DBA): <u>Texas Roadhouse</u>		
Address of Premises: <u>519 South Duff Avenue</u>		
City <u>Ames</u>	County: <u>Story</u>	Zip: <u>50010</u>
Business <u>(515) 232-7427</u>		
Mailing <u>6040 Dutchmans Lane</u>		
City <u>Louisville</u>	State <u>KY</u>	Zip: <u>40205</u>

Contact Person

Name <u>Laura Young</u>	Phone: <u>(502) 638-5469</u>	Email <u>laura.young@texasroadhouse.com</u>
--------------------------------	-------------------------------------	----------------------------------------------------

Classification Class C Liquor License (LC) (Commercial)

Term: 12 months

Effective Date: 07/02/2020

Expiration Date:

Privileges:

Class C Liquor License (LC) (Commercial)

Status of Business

BusinessType: <u>Limited Liability Company</u>
Corporate ID Number: <u>XXXXXXXXXX</u> Federal Employer ID <u>XXXXXXXXXX</u>

Ownership

W. Kent Taylor

First Name: W. Kent **Last Name:** Taylor
City: Crestwood **State:** Kentucky **Zip:** 40014
Position: Chief Executive Officer
% of Ownership: 0.00% **U.S. Citizen:** Yes

Texas Roadhouse, Inc. (Publicly Traded Company)

First Name: Texas Roadhouse, Inc. **Last Name:** (Publicly Traded Company)
City: Louisville **State:** Kentucky **Zip:** 40205
Position: Manager/Owner
% of Ownership: 100.00% **U.S. Citizen:** Yes

Celia Catlett

First Name: Celia **Last Name:** Catlett
City: Louisville **State:** Kentucky **Zip:** 40207
Position: Gen Counsel / Corp Sec
% of Ownership: 0.00% **U.S. Citizen:** Yes

Chris Jacobsen

First Name:	<u>Chris</u>	Last Name:	<u>Jacobsen</u>		
City:	<u>Anchorage</u>	State:	<u>Kentucky</u>	Zip:	<u>40223</u>
Position:	<u>Chief Marketing Officer</u>				
% of Ownership:	<u>0.00%</u>	U.S. Citizen:	<u>Yes</u>		

Tonya Robinson

First Name:	<u>Tonya</u>	Last Name:	<u>Robinson</u>		
City:	<u>Shelbyville</u>	State:	<u>Kentucky</u>	Zip:	<u>40065</u>
Position:	<u>Chief Financial Officer</u>				
% of Ownership:	<u>0.00%</u>	U.S. Citizen:	<u>Yes</u>		

Doug Thompson

First Name:	<u>Doug</u>	Last Name:	<u>Thompson</u>		
City:	<u>Louisville</u>	State:	<u>Kentucky</u>	Zip:	<u>40222</u>
Position:	<u>Chief Operating Officer</u>				
% of Ownership:	<u>0.00%</u>	U.S. Citizen:	<u>Yes</u>		

Insurance Company Information

Insurance Company: <u>Twin City Fire Insurance Company</u>	
Policy Effective Date: <u>07/02/2019</u>	Policy Expiration <u>07/02/2020</u>
Bond Effective	Dram Cancel Date:
Outdoor Service Effective	Outdoor Service Expiration
Temp Transfer Effective	Temp Transfer Expiration Date:

Name of Applicant: <u>Casey's Marketing Company</u>		
Name of Business (DBA): <u>Casey's General Store #2298</u>		
Address of Premises: <u>428 Lincolnway</u>		
City <u>Ames</u>	County: <u>Story</u>	Zip: <u>5001000</u>
Business	<u>(515) 232-0024</u>	
Mailing	<u>PO Box 3001</u>	
City <u>Ankeny</u>	State <u>IA</u>	Zip: <u>500218045</u>

Contact Person

Name JESSICA FISHER, Store Operations
Phone: (515) 446-6404 Email JESSICA.FISHER@caseys.com

Classification Class C Beer Permit (BC)

Term:12 months

Effective Date: 01/04/2020

Expiration Date:

Privileges:

Class C Beer Permit (BC)

Status of Business

BusinessType: <u>Publicly Traded Corporation</u>
Corporate ID Number: <u>XXXXXXXXXX</u> Federal Employer ID <u>XXXXXXXXXX</u>

Ownership

42-0935283 Casey's General Stores, Inc

First Name: <u>42-0935283</u>	Last Name: <u>Casey's General Stores, Inc</u>
City: <u>Ankeny</u>	State: <u>Iowa</u> Zip: <u>50021-804</u>
Position: <u>Owner</u>	
% of Ownership: <u>100.00%</u>	U.S. Citizen: <u>No</u>

JULIA JACKOWSKI

First Name: <u>JULIA</u>	Last Name: <u>JACKOWSKI</u>
City: <u>Urbandale</u>	State: <u>Iowa</u> Zip: <u>50322</u>
Position: <u>Secretary</u>	
% of Ownership: <u>0.00%</u>	U.S. Citizen: <u>Yes</u>

James Pistillo

First Name: <u>James</u>	Last Name: <u>Pistillo</u>
City: <u>Urbandale</u>	State: <u>Iowa</u> Zip: <u>50323</u>
Position: <u>Treasurer</u>	
% of Ownership: <u>0.00%</u>	U.S. Citizen: <u>Yes</u>

JOHN SOUPENE**First Name:** JOHN**Last Name:** SOUPENE**City:** ANKENY**State:** Iowa**Zip:** 50023**Position:** VICE-PRESIDENT**% of Ownership:** 0.00%**U.S. Citizen:** Yes**MEGAN ELFERS****First Name:** MEGAN**Last Name:** ELFERS**City:** CLIVE**State:** Iowa**Zip:** 50325**Position:** PRESIDENT**% of Ownership:** 0.00%**U.S. Citizen:** Yes**Insurance Company Information****Insurance Company:** First Western Insurance**Policy Effective Date:****Policy Expiration****Bond Effective****Dram Cancel Date:****Outdoor Service Effective****Outdoor Service Expiration****Temp Transfer Effective****Temp Transfer Expiration Date:**

Applicant License Application (LE0002744)

Name of Applicant: <u>Casey's Marketing Company</u>		
Name of Business (DBA): <u>Casey's General Store #2560</u>		
Address of Premises: <u>3020 S Duff Ave</u>		
City <u>Ames</u>	County: <u>Story</u>	Zip: <u>50010</u>
Business	<u>(515) 232-1148</u>	
Mailing	<u>PO Box 3001</u>	
City <u>Ankeny</u>	State <u>IA</u>	Zip: <u>50021</u>

Contact Person

Name	<u>JESSICA FISHER, Store Operations</u>		
Phone:	<u>(515) 446-6404</u>	Email	<u>JESSICA.FISHER@caseys.com</u>

Classification Class E Liquor License (LE)

Term: 12 months

Effective Date: 06/29/2020

Expiration Date:

Privileges:

Class E Liquor License (LE)

Status of Business

BusinessType:	<u>Publicly Traded Corporation</u>		
Corporate ID Number:	<u>XXXXXXXXXX</u>	Federal Employer ID	<u>XXXXXXXXXX</u>

Ownership

42-0935283 Casey's General Stores, Inc.

First Name: 42-0935283 **Last Name:** Casey's General Stores, Inc.
City: Ankeny **State:** Iowa **Zip:** 50021
Position: Owner
% of Ownership: 100.00% **U.S. Citizen:** Yes

JULIA JACKOWSKI

First Name: JULIA **Last Name:** JACKOWSKI
City: Urbandale **State:** Iowa **Zip:** 50322
Position: Secretary
% of Ownership: 0.00% **U.S. Citizen:** Yes

James R. Pistillo

First Name: James R. **Last Name:** Pistillo
City: Urbandale **State:** Iowa **Zip:** 50323
Position: Treasurer
% of Ownership: 0.00% **U.S. Citizen:** Yes

JOHN SOUPENE

First Name: JOHN **Last Name:** SOUPENE
City: ANKENY **State:** Iowa **Zip:** 50023
Position: VICE-PRESIDENT
% of Ownership: 0.00% **U.S. Citizen:** **Yes**

MEGAN ELFERS

First Name: MEGAN **Last Name:** ELFERS
City: CLIVE **State:** Iowa **Zip:** 50325
Position: PRESIDENT
% of Ownership: 0.00% **U.S. Citizen:** **Yes**

Insurance Company Information

Insurance Company: <u>Merchants Bonding Company</u>	
Policy Effective Date: <u>06/29/2019</u>	Policy Expiration <u>01/01/1900</u>
Bond Effective <u>2</u>	Dram Cancel Date:
Outdoor Service Effective	Outdoor Service Expiration
Temp Transfer Effective	Temp Transfer Expiration Date:

Applicant License Application (LE0003019)

Name of Applicant: <u>CASEY'S MARKETING</u>		
Name of Business (DBA): <u>CASEY'S GENERAL STORE #2905</u>		
Address of Premises: <u>3612 STANGE RD</u>		
City <u>Ames</u>	County: <u>Story</u>	Zip: <u>50010</u>
Business	<u>(515) 233-4089</u>	
Mailing	<u>PO BOX 3001</u>	
City <u>ANKENY</u>	State <u>IA</u>	Zip: <u>50021</u>

Contact Person

Name	<u>JESSICA.FISHER@CASEYS.COM</u>		
Phone:	<u>(515) 446-6404</u>	Email	<u>JESSICA.FISHER@CASEYS.COM</u>

Classification Class E Liquor License (LE)

Term: 12 months

Effective Date: 04/01/2020

Expiration Date:

Privileges:

Class E Liquor License (LE)

Status of Business

BusinessType:	<u>Publicly Traded Corporation</u>		
Corporate ID Number:	<u>XXXXXXXXXX</u>	Federal Employer ID	<u>XXXXXXXXXX</u>

Ownership

42-0935283 CASEY'S GENERAL

STORE INC

First Name: 42-0935283 **Last Name:** CASEY'S GENERAL STORE, INC.

City: ANKENY **State:** Iowa **Zip:** 50021

Position: OWNER

% of Ownership: 100.00% **U.S. Citizen:** Yes

JOHN SOUPENE

First Name: JOHN **Last Name:** SOUPENE

City: ANKENY **State:** Iowa **Zip:** 50023

Position: VICE-PRESIDENT

% of Ownership: 0.00% **U.S. Citizen:** Yes

JULIA JACKOWSKI

First Name: JULIA **Last Name:** JACKOWSKI

City: URBANDALE **State:** Iowa **Zip:** 50322

Position: SECRETARY

% of Ownership: 0.00% **U.S. Citizen:** Yes

JAMES PISTILLO

First Name: JAMES **Last Name:** PISTILLO
City: URBANDALE **State:** Iowa **Zip:** 50323
Position: TREASURER
% of Ownership: 0.00% **U.S. Citizen:** Yes

MEGAN ELFERS

First Name: MEGAN **Last Name:** ELFERS
City: CLIVE **State:** Iowa **Zip:** 50325
Position: PRESIDENT
% of Ownership: 0.00% **U.S. Citizen:** Yes

Insurance Company Information

Insurance Company: <u>Merchants Bonding Company</u>	
Policy Effective Date: <u>04/01/2019</u>	Policy Expiration <u>01/01/1900</u>
Bond Effective <u>2</u>	Dram Cancel Date:
Outdoor Service Effective	Outdoor Service Expiration
Temp Transfer Effective	Temp Transfer Expiration Date:

Name of Applicant: <u>Kum & Go LC</u>		
Name of Business (DBA): <u>Kum & Go # 1215</u>		
Address of Premises: <u>4506 Lincoln Way</u>		
City <u>Ames</u>	County: <u>Story</u>	Zip: <u>50010</u>
Business <u>(515) 292-4368</u>		
Mailing <u>1459 Grand Avenue</u>		
City <u>Des Moines</u>	State <u>IA</u>	Zip: <u>50309</u>

Contact Person

Name <u>Drew Carter</u>
Phone: <u>(515) 457-6188</u> Email <u>licenses@kumandgo.com</u>

Classification Class E Liquor License (LE)

Term: 12 months

Effective Date: 08/28/2019

Expiration Date:

Privileges:

Class E Liquor License (LE)

Fills and Sells Growlers

Status of Business

BusinessType: <u>Limited Liability Company</u>
Corporate ID Number: <u>XXXXXXXXXX</u> Federal Employer ID <u>XXXXXXXXXX</u>

Ownership

Kyle Krause

First Name: Kyle **Last Name:** Krause
City: Waukee **State:** Iowa **Zip:** 50263
Position: CEO
% of Ownership: 0.00% **U.S. Citizen:** Yes

Craig Bergstrom

First Name: Craig **Last Name:** Bergstrom
City: Johnston **State:** Iowa **Zip:** 50131
Position: CFO
% of Ownership: 0.00% **U.S. Citizen:** Yes

Charles Campbell

First Name: Charles **Last Name:** Campbell
City: Urbandale **State:** Iowa **Zip:** 50323
Position: Secretary

% of Ownership: 0.00%

U.S. Citizen: Yes

Krause Group LTD

First Name: Krause Group

Last Name: LTD

City: Des Moines

State: Iowa

Zip: 50309

Position: shareholder

% of Ownership: 100.00%

U.S. Citizen: Yes

Insurance Company Information

Insurance Company: <u>Merchants Bonding Company</u>	
Policy Effective Date: <u>08/28/2018</u>	Policy Expiration <u>01/01/1900</u>
Bond Effective <u>2</u>	Dram Cancel Date:
Outdoor Service Effective	Outdoor Service Expiration
Temp Transfer Effective	Temp Transfer Expiration Date:

Name of Applicant: <u>Mandarin Restaurant of Ames,Inc</u>		
Name of Business (DBA): <u>Mandarin Restaurant</u>		
Address of Premises: <u>415 LINCOLN WAY</u>		
City <u>Ames</u>	County: <u>Iowa</u>	Zip: <u>50010</u>
Business <u>(515) 233-5300</u>		
Mailing <u>415 Lincoln way</u>		
City <u>Ames</u>	State <u>IA</u>	Zip: <u>50010</u>

Contact Person

Name <u>Gary Pei</u>	
Phone: <u>(515) 291-8006</u>	Email <u>garypei888@hotmail.com</u>

Classification Special Class C Liquor License (BW) (Beer/Wine)

Term:6 months

Effective Date: 09/17/2019

Expiration Date: 01/01/1900

Privileges:

Special Class C Liquor License (BW) (Beer/Wine)

Sunday Sales

Status of Business

BusinessType: <u>Privately Held Corporation</u>	
Corporate ID Number: <u>XXXXXXXXXX</u>	Federal Employer ID <u>XXXXXXXXXX</u>

Ownership

Gary Pei

First Name: Gary

Last Name: Pei

City: Ames

State: Iowa

Zip: 50010

Position: President

% of Ownership: 51.00%

U.S. Citizen: Yes

Insurance Company Information

Insurance Company: <u>Continental Western Insurance Company</u>	
Policy Effective Date: <u>09/17/2019</u>	Policy Expiration <u>03/17/2020</u>
Bond Effective	Dram Cancel Date:
Outdoor Service Effective	Outdoor Service Expiration
Temp Transfer Effective	Temp Transfer Expiration Date:

Name of Applicant: <u>The Love Club, LLC</u>		
Name of Business (DBA): <u>The Love Club, LLC</u>		
Address of Premises: <u>4625 Reliable St</u>		
City <u>Ames</u>	County: <u>Story</u>	Zip: <u>50014</u>
Business <u>(515) 231-2907</u>		
Mailing <u>3122 Ross Rd</u>		
City <u>Ames</u>	State <u>IA</u>	Zip: <u>50014</u>

Contact Person

Name <u>Lyndsay Nissen</u>	
Phone: <u>(515) 231-2907</u>	Email <u>lyndsaynissen@gmail.com</u>

Classification Special Class C Liquor License (BW) (Beer/Wine)

Term: 12 months

Effective Date: 07/15/2019

Expiration Date: 01/01/1900

Privileges:

- Class B Native Wine Permit
- Outdoor Service
- Special Class C Liquor License (BW) (Beer/Wine)
- Sunday Sales

Status of Business

BusinessType: <u>Limited Liability Company</u>	
Corporate ID Number: <u>XXXXXXXXXX</u>	Federal Employer ID <u>XXXXXXXXXX</u>

Ownership

Elliot Thompson

First Name: Elliot **Last Name:** Thompson
City: Ames **State:** Iowa **Zip:** 50014
Position: Owner
% of Ownership: 50.00% **U.S. Citizen:** Yes

Lyndsay Nissen

First Name: Lyndsay **Last Name:** Nissen
City: Ames **State:** Iowa **Zip:** 50014
Position: Owner
% of Ownership: 50.00% **U.S. Citizen:** Yes

Insurance Company Information

Insurance Company: Illinois Casualty Co

Policy Effective Date: 07/15/2019

Policy Expiration 07/14/2020

Bond Effective

Dram Cancel Date:

Outdoor Service Effective

Outdoor Service Expiration

Temp Transfer Effective

Temp Transfer Expiration Date:

Applicant License Application ()

Name of Applicant: <u>New Hickory Holding Company</u>		
Name of Business (DBA): <u>New Hickory Holding Company</u>		
Address of Premises: <u>1404 S. Duff Avenue</u>		
City <u>Ames</u>	County: <u>Story</u>	Zip: <u>50010</u>
Business <u>(515) 225-9029</u>		
Mailing <u>1001 Grand Avenue</u>		
City <u>West Des Moines</u>	State <u>IA</u>	Zip: <u>50265</u>

Contact Person

Name Tom Bernau
Phone: (515) 225-9029 Email tbernau@bernaucapital.com

Classification Special Class C Liquor License (BW) (Beer/Wine)

Term: 12 months

Effective Date: 08/31/2019

Expiration Date: 01/01/1900

Privileges:

Living Quarters

Special Class C Liquor License (BW) (Beer/Wine)

Sunday Sales

Status of Business

BusinessType: <u>Privately Held Corporation</u>
Corporate ID Number: <u>XXXXXXXXXX</u> Federal Employer ID <u>XXXXXXXXXX</u>

Ownership

Thomas Bernau

First Name: Thomas **Last Name:** Bernau
City: West Des Moines **State:** Iowa **Zip:** 50265
Position: President
% of Ownership: 100.00% **U.S. Citizen:** Yes

Insurance Company Information

Insurance Company: <u>Selective Insurance Company of America</u>	
Policy Effective Date:	Policy Expiration
Bond Effective	Dram Cancel Date:
Outdoor Service Effective	Outdoor Service Expiration
Temp Transfer Effective Date	Temp Transfer Expiration Date:



MEMO

Item No. 13

To: Mayor John Haila and Ames City Council Members
From: Lieutenant Tom Shelton, Ames Police Department
Date: August 21, 2019
Subject: Beer Permits & Liquor License Renewal Reference City Council Agenda

The Council agenda for August 21, 2019 includes beer permits and liquor license renewals for:

- Class E Liquor License with Class B Wine, Class C Beer and Sunday Sales – Kwik Stop Liquor & Groceries, 125 6th Street
- Class E Liquor License with Class B Wine, Class C Beer and Sunday Sales - Hy-Vee Drugstore, 500 Main St
- Class E Liquor License with Class B Wine, Class C Beer and Sunday Sales - Cyclone Liquors, 626 Lincoln Way
- Class C Liquor License with Outdoor Service and Sunday Sales - Grandpa Noodle Gallery, 926 S 16th Street

A review of police records for the past 12 months found no liquor law violations for any of the above locations. The Ames Police Department recommends renewal of licenses for all the above businesses.

ISU Fireworks Permit Application

Fireworks, Pyrotechnics or Flame Effects Application
Iowa State University of Science and Technology

Applicant Information

Name of Event: Iowa State University - 2019 Football Season
 Name of Organization Sponsoring Event: Iowa State University - Athletics Marketing
 Address of Organization: Intercollegiate Athletics Marketing Office, Jacobson Athletic Bldg., Ames, IA 50011
 Name of Applicant: Mary Pink - Associate Athletics Director
 Phone: 515.294.1534 Fax: 515.294.2988 E-Mail: mpink@iastate.edu

Event Information

Event Location: Jack Trice Stadium - See Attached Aerial View Estimated attendance: 85,000
 Event Date: See Attached Time: See Attached a.m./p.m. Alternate Date (rain date) for event: N/A
 Organization's on-site manager or contact for day of Display: Mary Pink - Associate Athletics Director
 Phone: 515.294.1534 Fax: 515.294.2988 E-Mail: mpink@iastate.edu

Firework Display Information: Attach a copy of the Display Operator credentials and applicable U.S. DOT requirement information for transportation with this application

Display Operator (company name): J & M Displays
 Address: 4104 83rd Street
 City: Urbandale State: IA Zip Code: 50322
 Work-week Phone: 515.321.2761 Fax: 515.276.6828 E-Mail: kelnbrueschke@gmail.com
 Operator Name for day of Display: Kelm Brueschke Cell Phone: 515.321.2761
 Other Contact for day of Display: Mike Merrill Cell Phone: 641.891.9689

NOTE: Electronic firing ONLY

Type of Fireworks: Flames & Close Proximate Pyrotechnics **Attach Display Program**
 Length of Display: 60 - 90 Seconds
 Fireworks Supplier: J & M Displays
 Exact Location of Display: Jack Trice Stadium - See Attached Aerial View **Attach Diagram of Display/Shoot Location**

Insurance Requirements: Insurance coverage and certificate requirements are on the back of this form.

Student Organizations Only: Submit an Event Authorization and Notification Form with other event documents (including this application) at least 6 weeks prior to the event.

The display operator, EH&S and ISU Police will monitor weather conditions prior to and during the display event. EH&S, ISU Police or the Ames Fire Department have the authority to cancel or postpone any display if they determine there is not strict adherence to the approved application; or there is lightning, wind gusts or inclement weather that will cause risks to the crowd or surrounding property.

8/16/19
Date

Mary Pink
Sponsoring Organization Representative Signature

I have read and agree to the responsibilities stated in the ISU Fireworks, Pyrotechnics and Flame Effects Procedures and also agree that I will meet all insurance requirements listed on this application and that this insurance will be primary.

August 14th, 2019
Date

Kelm P Brueschke
Display Operator Representative Signature

APPROVAL SIGNATURES:
8/20/19
Date

Ray Lewis
Environmental Health and Safety

8/20/19
Date

Michael R. Wentz
ISU Police

21 Aug 2019
Date

[Signature]
City of Ames Fire Inspector

8/21/19
Date

Susan [Signature]
Office of Risk Management

Show Details:

Event Name: Iowa State University – 2019 Football Season

Organization: Iowa State University Athletics Marketing

Contact: Mary Pink

Address: Intercollegiate Athletics Marketing Office, Jacobson Athletic Building
Ames, IA 50011-1140

Phone: 515.294.1534

Fax: 515.294.2988

Email: mpink@iastate.edu

Venue: Jack Trice Stadium – See Attached Aerial View for Effects

Responding Fire Department: Ames Fire Department - Ames, IA

Show Dates/Times: 2019 Football Season Schedule

- Game 1: Saturday August 31st, 2019 – 11:00 a.m. (UNI)
- Game 2: Saturday September 14th, 2019 – 11:00 a.m. (Iowa)
- Game 3: Saturday September 23rd, 2019, – TBA (Louisiana-Monroe) change to 9/21/2019
- Game 4: Saturday October 5th, 2019 – TBA (TCU)
- Game 5: Saturday October 26th, 2019 – TBA (Oklahoma State – Homecoming)
- Game 6: Saturday November 16th, 2019 – TBA (Texas)
- Game 7: Saturday November 23rd, 2019 – TBA (Kansas)

Duration of Show: 60 – 90 Seconds

Lead Display Operator:

Kelm Brueschke – Credentials – See Attached

- PGI Certified Shooter/Trainer
- Minnesota Fireworks License & Indoor - Close Proximity License
- Missouri Fireworks License & Indoor - Close Proximity License
- Cell Phone: 515.321.2761

Back-up Display Operator:

Mike Merrill – Credentials

- PGI Certified Shooter
- Cell Phone: 641.990.6760

Pyrotechnic Products Proposed – Games 1, 2, 3, 4, 5, 6 & 7:

Quantity	Type/Class	Description
4	Indoor/Outdoor	Flame Heads – 4 Galaxis G-Flame Propane/Canister Systems

Pyrotechnic Products Proposed – No Games identified, but will do this if a night game comes up:

Quantity	Type/Class	Description
50	Close Prox (1.4g)	100mm Mines
50	Close Prox (1.4g)	48mm Mines
50	Close Prox (1.4g)	40mm Comets
50	Close Prox (1.4g)	30mm Comets
50	Close Prox (1.4g)	1 x 65' Gerbs
50	Close Prox (1.4g)	1 x 50' Gerbs



PERMIT TO DISPLAY FIREWORKS APPLICATION

Name of Event ISU 2019 Football - Flames & Pyrotechnic

Date & Time of Event See Attached **Rain Date & Time** TBD

Applicant Name Mary Pink **Phone** 515.294.1534

Email mpink@iastate.edu

Organization Name Iowa State University Athletics Mktg

Address Athletics Mktg Office - Jacobson Bldg

City Ames **State** IA **Zip Code** 50011

Contact for Day of Display Mary Pink **Phone** 515.231.4286

Exact location of shoot/display Jack Trice Stadium - See attached view

Attach diagram of display location

Size of shells and/or type of display No Shells - Flames Only

Attach effects list or schedule

Name of Display Operator/Responsible Shooter Kelm Brueschke

(This person is to be present on the day of the event.)

Attach a resume showing pyrotechnic certification/qualifications

Phone number for Display Operator/Responsible Shooter 515.321.2761

Name of Insurance Company Britton Gallagher - Everest Indemnity

See below for detailed information about insurance requirements.

Display sites are subject to examination by the City Fire Inspector or his/her designee. The Ames Fire Department has authority to cancel/postpone any display if it is determined that there are safety concerns.

Applicant Signature *Mary Pink* **Date** 8/16/19

Display Operator Signature *Kelm P Brueschke* **Date** 8/14/2019

City of Ames Insurance Requirements:

- Comprehensive General Liability limits in the amount of \$1,000,000 combined single limit and Excess Liability limits in the amount of \$5,000,000. Coverage shall be at least as broad as the ISO Form Number CG0001 covering commercial general liability written on an occurrence basis only.
- Applicant and/or Sponsor must be named as certificate holder(s)
- The City of Ames, its officers and employees must be named as additional insured.
- A copy of the current insurance certificate must be filed with the City Clerk.

NOTE: This application not to be used for displays originating on Iowa State University property.

Submit your completed permit application to: rknutson@city.ames.ia.us

City of Ames
City Clerk's Office
PO Box 811
Ames, IA 50010

For displays on property owned by Iowa State University, an alternate application must be submitted to ISU Risk Management at least six (6) weeks prior to the event. Please refer to forms and information found at: <http://www.riskmanagement.iastate.edu/events/fireworks> or contact the ISU Office of Risk Management at 515-294-7711.

For Office Use Only

Documents Received

Date: _____

___ Completed Application

___ Sketch

___ ISU Property

Fee

___ Fee \$25.00

Date Fee Paid _____

Insurance

___ Received _____

___ Approved _____

Follow Up

___ Application approved

___ Fire Inspector approved

___ Permits database updated

___ Permit Letter prepared

___ Letter copied and mailed

City Council Meeting

___ Added to Agenda

___ City Council Approved

Permit Number _____

Special Conditions:

Application Denial Reasons:

COUNCIL ACTION FORM

SUBJECT: CERTIFICATE OF CONSISTENCY WITH THE CITY'S 2014-2019 CDBG CONSOLIDATED PLAN ON BEHALF OF YOUTH AND SHELTER SERVICES (YSS), INC.

BACKGROUND:

Since 1995, Youth and Shelter Services (YSS) has received grant funds through the Department of Housing & Urban Development's (HUD) Supportive Housing Program (SHP). Under this program, YSS administers its Lighthouse Transitional Living Programs in Story, Boone, Hardin, and Marshall Counties. The Lighthouse Transitional Living Program targets young mothers who are 16-25 years of age, homeless youth ages 16-21, and homeless pregnant/parenting women ages 16-25 with their children. The HUD funds are for leasing of rental properties, supportive services, and operations for the clients.

The YSS renewal funding application request is for approximately \$141,100 of which approximately \$21,390 is designated for Ames/Story County. YSS is in the process of preparing their 2020-21 Supportive Housing Program renewal application that will be submitted as part of the State of Iowa's Balance of State Continuum of Care Application on or by August 16, 2019.

Since Ames is a designated CDBG entitlement community, agencies requesting funding from HUD must have approval from the City that their program application matches the goals of the City's Consolidated Plan. Therefore, in order for YSS to submit its application to the State of Iowa, they must receive a certification (see attachment) from the City of Ames that their application is consistent with the goals outlined in the most current City's Consolidated Plan.

ALTERNATIVES:

1. The City Council can authorize the Mayor to sign the Certificate of Consistency on behalf of YSS.
2. The City Council can deny approval authorizing the Mayor to sign the Certificate of Consistency on behalf of YSS.

MANAGER'S RECOMMENDED ACTION:

Staff has determined that the YSS program application is consistent with the goals outlined in the City's current CDBG 2014-2018 Consolidated Plan.

Therefore, it is the recommendation of the City Manager that the City Council adopt Alternative #1 which will authorize the Mayor to sign the Certificate of Consistency on behalf of YSS to submit an application for Supportive Housing Program funding to the Iowa Finance Authority.

CERTIFICATION OF LOCAL GOVERNMENT APPROVAL

**FOR NONPROFIT ORGANIZATIONS RECEIVING IOWA STATEWIDE
EMERGENCY SOLUTIONS GRANT (ESG) FUNDS FOR SHELTER**

ESG Nonprofit Recipient:	ACCESS-Assault Care Center Extending Shelter and Support
ESG Shelter Project:	ACCESS Shelter/Emergency Housing Program
Unit of General Purpose Local Government for the geographic area served (city or county):	City of Ames
Project Description (2-3 sentences):	ACCESS provides 14-16 beds of shelter through a scattered site model within the City of Ames. Additionally, ACCESS compliments shelter with rapid rehousing, homelessness prevention and essential community based support services.

I certify that I am duly authorized to act on behalf of the unit of general purpose local government named above, and that I hereby approve* of this project.

By: _____
Signature

Date

Printed Name and Title of Signatory Local Official

* This approval is made to carry out 24 CFR Part 576.202(a), which states the following:

"...The recipient must subgrant the remaining funds in its fiscal year grant to:

- (1) Units of general purpose local government in the State, which may include metropolitan cities and urban counties that receive ESG funds directly from HUD; or
- (2) Private nonprofit organizations, provided that for emergency shelter activities the recipient obtains a certification of approval from the unit of general purpose local government for the geographic area in which those activities are to be carried out."

Iowa Statewide ESG Policy: This certification is required at least once every two years.

Form updated 5/10/2018

COUNCIL ACTION FORM

**SUBJECT: REQUEST TO WAIVE ENFORCEMENT OF PROHIBITION OF
MOTORIZED VEHICLES IN ADA HAYDEN HERITAGE PARK**

BACKGROUND:

Each September from 2004 through 2011, members of the local Moose Lodge provided golf cart rides around Ada Hayden Heritage Park (AHHP) for older adults with mobility impairments. Lodge members determined that if they did not provide this service, these individuals may never get to experience the overall beauty of the 437 acre site. Please note that mobility impaired individuals can use motorized mobility devices (i.e. electric wheelchairs, motorized mobility scooters, etc.) on the trails, however, many individuals do not have this type of device that enables them to enjoy the park system.

In 2016 through 2018, the Friends of Ada Hayden Heritage Park (Friends) provided this valuable service to individuals with mobility impairments and received many positive comments. As a result, the Friends are proposing to offer tours on Thursday, September 12, 2019, between 8:00 AM and 5:00 PM. The Friends will rent golf carts, provide volunteers as drivers and interpreters, and provide the City with a Certificate of Insurance to cover liability. Tours will be promoted and reservations will be taken for various time slots.

This opportunity has been well received in the past, however, Ordinance 19.9 restricts motorized vehicles to streets and parking lots. **Therefore, the Friends are requesting City Council waive the enforcement of this Ordinance on Thursday, September 12 between the hours of 8:00 AM and 5:00 PM at AHHP. In the event of inclement weather, they will use Friday, September 13 as a rain date.**

The Parks and Recreation Commission reviewed this request at its August 15, 2019 meeting recommending City Council grant this waiver.

ALTERNATIVES:

1. Waive enforcement of Ordinance 19.9 between the hours of 8:00 AM and 5:00 PM on Thursday, September 12 as well as Friday, September 13 if needed for a rain date, at Ada Hayden Heritage Park to allow the Friends of Ada Hayden Heritage Park to provide golf cart tours to mobility impaired individuals.

2. Deny the request to waive enforcement of Ordinance 19.9 between the hours of 8:00 AM and 5:00 PM on Thursday, September 12, as well as Friday, September 13 if needed for a rain date, at Ada Hayden Heritage Park to allow the Friends of Ada Hayden Heritage Park to provide golf cart tours to mobility impaired individuals.

CITY MANAGER'S RECOMMENDATION:

The Friends of Ada Hayden Heritage Park are proposing to provide a tremendous service for members of our community that otherwise would not have the opportunity to tour this park in its entirety. Therefore, it is City Manager's recommendation to approve Alternative #1 as stated above.

16 July 2019

Keith Abraham and Ames Parks Commissioners
Director of Ames Parks and Recreation
Email: kabraham@city.ames.ia.us

Dear Keith and Parks Commissioners:

For the past several years, the Friends of Ada Hayden Heritage Park have held a one-day opportunity in the fall for Ames folks who have mobility issues to access Ada Hayden Park. We have rented golf carts from an Ankeny firm, provided a driver/interpreter for each one, and provided 1.5-2 hour tours of the park for these folks. The reviews have consistently been outstanding, with 60-80 people participating each year. We have, in the past, contacted various senior housing operations in Ames (Northcrest, Green Hills, etc.) plus Mainstream Living. The response has always been enthusiastic.

We would like to offer this opportunity again in fall, 2019. Our proposed date is Thursday, September 12, 2019, with a rain date of Friday, September 13, 8:00 a.m. to 5:00 p.m. on those days. We seek approval from both the Parks Commission and Ames City Council for temporarily suspending the "no motorized vehicles" rule on the trails to hold this special event.

The Friends of Ada Hayden are happy to provide this service to mobility challenged citizens of Ames at no cost to the City or the Parks Department. We hope you will approve this request. Please let me know if you have questions or concerns with this request.

Thank you for your consideration.

Best,

A handwritten signature in black ink that reads "James Pease". The signature is written in a cursive style with a large, looping initial "J".

James Pease, President
Friends of Ada Hayden Heritage Park

COUNCIL ACTION FORM

SUBJECT: **FUNDING REQUEST FOR 2019 SYMPOSIUM
ON BUILDING INCLUSIVE ORGANIZATIONS**

BACKGROUND:

Like other cities across the country that are impacted by increased incidents of racism, vandalism, and violence against humanity; Ames/Story County is not immune from these types of issues. Therefore, in October 2018 the City of Ames, the Ames Human Relations Commission (AHRC), the Ames Chamber of Commerce, and the Iowa State University of Diversity and Inclusion partnered together to host the first “Symposium on Building Inclusive Organizations” event to educate, raise awareness, and provide resources for the leaders in our community. The event was a deemed a major success with over 250 participants from the community.

On January 24, 2019, the Mayor and City Council received a letter from Dan Culhane, President & CEO of the Ames Chamber of Commerce seeking the City’s and Ames Human Relations Commission’s support to host a 2109 “Symposium on Building Inclusive Organizations” event. This year’s event will be held on Tuesday, October 27, 2019 and again will be held at the Gateway Hotel and Conference Center. The preliminary budget for the event is approximately \$47,000.

Each primary partner is being asked again to contribute \$5,000 towards the cost of hosting the event which will help cover breakfast, honorariums, speaker fees, lunches, marketing & promotion and signage/staging. If approved by the City Council, the City’s \$5,000 contribution would be comprised of \$4,000 from Council Contingency (which currently has a balance of \$25,000) and \$1,000 from funds currently appropriated for the Ames Human Relations Commission (which received a positive recommendation from the Commission at their January 2019 meeting). The \$5,000 contribution will include 10 tickets for each organization. Besides the funding from the City, ISU, and the Chamber, revenue for the event will be generated from participant registration fees and sponsorships.

ALTERNATIVES:

1. The City Council can authorize the expenditure of \$5,000 (\$4,000 from the Council Contingency account and \$1,000 from funds budgeted for AHRC activities) in support of the 2019 Symposium on Building Inclusive Organizations event in partnership with the Ames Chamber of Commerce and the Iowa State University of Diversity and Inclusion.
2. The City Council can choose to not authorize the expenditure of \$5,000 (\$4,000 from the Council Contingency account and \$1,000 from funds budgeted for AHRC activities) in support of the 2019 Symposium on Building Inclusive Organizations event in partnership with the Ames Chamber of Commerce and the Iowa State University of Diversity and Inclusion.

CITY MANAGER'S RECOMMENDED ACTION:

This event offers the City the opportunity to partner with other groups and organizations to educate our citizens regarding this important topic of creating “one community.”

Therefore, it is the recommendation of the City Manager that the City Council adopt Alternative No. 1, thereby authorizing the expenditure of \$5,000 (\$4,000 from the Council Contingency account and \$1,000 from funds budgeted for AHRC activities) in support of The 2019 Symposium on Building Inclusive Organizations event in partnership with the Ames Chamber of Commerce and the Iowa State University of Diversity and Inclusion.



Smart Choice

January 24, 2019

The Honorable Mayor John Haila
City of Ames
515 Clark Ave.
Ames, IA 50010

RE: Symposium on Building Inclusive Organizations

Mayor Haila,

I want to thank you, the Ames City Council, and the Ames Human Relations Commission for your support of the inaugural Symposium on Building Inclusive Organizations. The October 2018 event was a major success with 250 community members in attendance.

The overwhelmingly positive response to our first attempt at such an event has given us a clear directive to begin the planning for the second annual Symposium. The 2019 event will be held Tuesday, October 29th of this year. I write to you respectfully seeking your partnership, once again.

Diversity and inclusivity are paramount to the success of our residents, businesses, and community so as our planning process moves forward, I request your continued partnership with a \$5000 sponsorship to support this endeavor. The Ames Chamber of Commerce will once again be financially supporting this event and a similar request is being made to Iowa State University, along with other local partners.

Our board of directors understands that making our community more diverse and inclusive is of utmost importance, and an ongoing process, with the Symposium being one way to educate and raise awareness in our community.

Thank you again for your support in 2018. I appreciate your anticipated consideration of this request for 2019 and we look forward to a great event in October!

Sincerely,

A handwritten signature in black ink that reads 'Daniel A. Culhane'.

Daniel A. Culhane, CECD, CCE
President & CEO
Ames Chamber of Commerce

CC: Gloria Betcher, Ward I
Tim Gartin, Ward II
David Martin, Ward III

COUNCIL ACTION FORM

SUBJECT: RESOLUTION APPROVING SUBORDINATE MORTGAGE FOR THE PROPERTY LOCATED AT 712 BURNETT (YSS) IN CONNECTION WITH THE CITY'S CDBG MINOR REPAIR PROGRAM FOR NON-PROFITS.

BACKGROUND:

In June 2007, Youth and Shelter Services (YSS) participated in the City's CDBG Minor Repair Program for local nonprofits organizations. Through this program, local nonprofits received 5-Year deferred loans to make minor repairs to their facilities. YSS received approximately \$9,900 to complete minor repairs at their 712 Burnett property.

To receive the financial assistance, YSS signed a Subordinate Mortgage agreement with the City of Ames that required a payback of the minor repair loan if the property was sold, transferred, rented, or unoccupied for a period or any default or breach of the program policies, procedures, agreements, etc. for a period five (5) years from the date of the agreement. The loan amount also decreased 20% per year, thereby if none of the conditions occurred the subordinate mortgage would be released.

Although YSS met the five (5) year commitment back in 2012, the release of the subordinated mortgage did not occur. The Department of Planning and Housing is requesting that the City Council authorize the release of the Subordinate Mortgage so that the lien recorded by the City against the above property can be released.

ALTERNATIVES:

1. The City Council can approve a resolution authorizing the Mayor to sign the attached Release of Contract and Lien for the property located at 712 Burnett Avenue in the CDBG Minor Repair Program.
2. The City Council can deny a resolution authorizing the Mayor to sign the attached Release of Contract and Lien for the property located at 712 Burnett Avenue in the CDBG Minor Repair Program.

CITY MANAGER'S RECOMMENDED ACTION:

The terms of the original agreement have been met by YSS. In order for YSS to have a clear title for the property it is important to provide a Release of the Contract and Lien for the property located at 712 Burnett Avenue.

Therefore, it is the recommendation of the City Manager that the City Council approve Alternative #1 as described above.

DO NOT WRITE IN THE SPACE ABOVE THIS LINE - RESERVED FOR RECORDER

Prepared by: Victoria Feilmeyer, City of Ames Legal Department, 515 Clark, Ames, Iowa 50010 Phone: 515-239-5146
Return to: Ames City Clerk, 515 Clark Avenue, P. O. Box 811, Ames, Iowa 50010-0811

RELEASE

(712 Burnett Avenue, Ames, Iowa)

Re: The South 55 feet of Lot Six (6), Block 3 in the Original Town of Ames, Iowa

THE CITY OF AMES, IOWA, a municipal corporation of the State of Iowa, hereby certifies that it has received full satisfaction under the terms of a certain Mortgage, dated the 7th day of August 2007, executed by Youth and Shelter Services, Inc., as Instrument Number 2007-09472 and filed in the records in the office of the County Recorder of Story County, Iowa, on August 13, 2007, and does hereby acknowledge full satisfaction of said Mortgage and release the lien upon the Real Property described in the Mortgage.

IN WITNESS WHEREOF, the said City has caused this instrument to be signed by its Mayor and City Clerk, and its seal to be affixed, this ____ day of August 2019, at Ames, Iowa.

CITY OF AMES, IOWA

By: _____

John A. Haila, Mayor

Attest: _____

Diane R. Voss, City Clerk

STATE OF IOWA, COUNTY OF STORY, SS.:

This instrument was acknowledged before me on _____, 2019, by John A. Haila and Diane R. Voss, as Mayor and City Clerk, respectively, of the City of Ames, Iowa.

NOTARY PUBLIC

ITEM # 19
DATE: 08/27/19

COUNCIL ACTION FORM

SUBJECT: **REQUESTS FOR RUN FOR THE ROSES**

BACKGROUND:

The members of Alpha Omicron Pi and the Ames Area Running Club are proposing to host their 33rd annual Run for the Roses event on Sunday, October 13th from 7:00 a.m. to 1:00 p.m. The event includes a 5k race/walk, 10k race, kid's run, and a post-race breakfast. An estimated 1,200 guests are anticipated to attend.

In order to facilitate the movement of participants, a Blanket Temporary Obstruction Permit and temporary street closures are required on the following streets on Sunday, October 13th from 6:00 a.m. to approximately 2:00 p.m.:

- Mortensen Road between Dotson Drive and State Avenue
- State Avenue between Lettie Street and Mortensen Road

Runners will use the shared-use path on the north side of Mortensen between State Avenue and Hayward Avenue. Additionally, runners will use coned-off portions of the following streets, which will remain open to traffic during the event:

- Hayward Avenue from Mortensen Road to Knapp Street
- Knapp Street from Hayward Avenue to Sheldon Avenue
- Sheldon Avenue from Knapp Street to Arbor Street
- Arbor Street from Sheldon Avenue to State Street

The streets will reopen as runners pass through each area. The route is configured to allow traffic through the south and east legs of the State/Mortensen intersection, which will reduce the length of detouring required compared to a full intersection closure.

Public Works Traffic Division will provide barricades and traffic cones to facilitate the road closures, and volunteers will staff them. Event organizers have indicated they will place signs in the affected areas prior to the event and will go door to door with event information. Campustown Action Association has provided a letter of support.

ALTERNATIVES:

1. Approve the road closures as requested by Alpha Omicron Pi and the Ames Area Running Club.
2. Deny the requests and direct staff to work with organizers to find an alternate location for the event.

CITY MANAGER'S RECOMMENDED ACTION:

Run for the Roses raises awareness for arthritis. Funds raised from the event benefits arthritis research. Alpha Omicron Pi and the Ames Area Running Club have contributed over \$385,000 to arthritis research grants.

Therefore, it is the recommendation of the City Manager that the City Council adopt Alternative No. 1, thereby approving the road closures as requested by Alpha Omicron Pi and the Ames Area Running Club.



SPECIAL EVENT APPLICATION

Applications received less than thirty (30) days before the event may not be processed by the City in time for the event and will automatically be denied. Each application is viewed as a new event regardless of previous occasions.

Event Name RUN FOR THE ROSES

Location/Address AMES MIDDLE SCHOOL

Region (Select one or more)

- Ames Main Street (Downtown)
- Campustown District
- Iowa State University Property
- City Parks
- Other (please explain)

Please note that events occurring in the Downtown, Campustown, in City parks, or on ISU property require prior approvals. A letter of support will be required from CAA if the event occurs in Campustown or from MSCD if the event occurs in Downtown. Please contact the appropriate office well in advance.

Downtown - Main Street Cultural District: (515) 233-3472 events@amesdowntown.org
 Campustown - Campustown Action Association: (515) 450-8771 director@amescampustown.com
 ISU - Events Authorization Committee: (515) 294-1437 eventauthorization@iastate.edu

TIMELINE

Setup Date 10/12/19 Time 11-1 PM M T W R F Sa Su
 Event Starts Date 10/13/19 Time 9 AM M T W R F Sa Su

Detailed Description of Event Activities (written overview of event and what's going to happen)

SEE ATTACHED BROCHURE

Event Ends Date 10/13/19 Time 1 PM M T W R F Sa Su
 Teardown Complete Date 10/13/19 Time 2 PM M T W R F Sa Su

Event Category

- Athletic/Recreation
- Exhibits/Misc.
- Festival/Celebration
- Parade/Procession/March
- Concert/Performance
- Farmer/Outdoor Market
- Other (please explain)

Rain Date N/A Rain Location N/A

Yes No

Is this an annual event? If yes, how many years? 33

For Office Use Only

Documents Received

Date: _____

- Completed Application
- Fireworks Application (\$25 fee)
- Insurance Certificate
- Public Safety & Event Management Plan
- Site Plan/Route Map (\$25 fee)
- Vendor List (\$50 fee/each)
- Parking fees

Special Events Meeting

Date: _____

Time: _____

Room: _____

Documents Sent:

- Alcohol License
- ABD
- Fireworks Permit
- Road Race Permit
- TOP
- Vending Permit
- Other

Departments Included

- City Manager: Brian Phillips and Tasheik Kerr
- CityRide: Jenny Bethuren or Rob Holm or Kevin Gries
- Electric: Mark Imhoff
- Fire: Jason Ziph or Rich Higgins
- Parks & Rec: Craig Kaufman or Joshua Thompson
- Public Works: Brad Becker or Dave Cole
- Police: Jason Tuttle or Geoff Huff
- Water: Heidi Petersen
- Risk Management: Bill Walton

CAA: Karen Chitty
 AMS: Jess Clyde or Sarah Dvorsky
 ISU: Events Authorization Committee

City Council Meeting

Date: _____
 Added to Agenda with CAF Approved Y N

Reminder Date: _____

CONTACTS

Sponsor/Applicant Name AMES AREA RUNNING CLUB/DON MUFF
 Address P.O. BOX 266
 City AMES State IA Zip Code 50010
 Daytime Phone 515-292-2925 Cell Phone 515-290-8836
 E-mail donmuff@tntmail.com
 Alternate Contact Name ROMAN LYNCH
 Daytime Phone N/A Cell Phone 515-231-9995
 E-mail roman.lynych@american-national.com

ATTENDANCE

Anticipated Daily Attendance 1,200+

Yes No

Is this event open to the public?

Is your event being held in conjunction with another event (e.g. Farmers' Market, 4th of July, etc.)? If yes, please list:

ORGANIZATION STATUS/PROCEEDS

- For-Profit
- Bona Fide Tax Exempt
- Nonprofit

Yes No

Are patron admission, entry, or participant fees required? If yes, please describe and provide amounts: SEE ATTACHED BROCHURE

Are vendor or other fees required? If yes, please provide amounts:

Percentage of net proceeds going towards fundraising 100 %

Percentage of net proceeds going towards for-profit entity %

SECURITY

Ames Police Department 24 hour non-emergency phone number: 515-239-5133

Please complete the course at <https://www.crowdmanagers.com/training> for crowd management training.

Yes No

Have you hired a professional security company to develop and manage your event's security plan? If yes, please fill out the following information:

Security Organization _____

Address _____

City _____

State _____

Zip _____

Phone _____

Email _____



campustown
action
association

Campustown Action Association
119 Stanton Ave, Suite 802
Ames, IA 50014

July 30, 2019

The Campustown Action Association is supportive of the Run for the Roses race being held October 13th. The course skirts around just the outer edges of the Campustown District. They have selected a Sunday morning, on an away game weekend, which further minimizes how the district and neighborhood is affected. Routes will be marked, they have a great volunteer base, and a proven history of successful events. CAA will add the event to our calendar and the CAA September newsletter as a way to help notify the district. We see no issues for concern and wish them great success for race day.

Sincerely,

Karin Chitty
Executive Director

From: "Don Muff Sr." <donjmuff@hotmail.com>
To: "Tasheik Kerr/COA" <TKerr@city.ames.ia.us>
Cc: "Captain Midnight" <roman.lynch@american-national.com>, "Ron Skrdla" <rkskrdla@agron.iastate.edu>

Date: Thursday, August 22, 2019 11:28AM
Subject: Fw: Run For The Roses Route Map--Street Closure Request

History: ✉ This message has been replied to and forwarded.

Hello Tasheik,

Organizers for the 33rd Annual Run For The Roses request the closure of State Street from Arbor to Mortensen and the closure of the West bound lanes of Mortensen from Dotson Dr to State Street occur on Oct. 13 from approx. 8AM to 11AM—as has been done in the past. The attached map gives all the details as does the brochure which was shared with you at our formal meeting with city officials.

Best Regards,

Don Muff
President, Ames Area Running Club, Co-Director, Run For The Roses
515-290-8837, donjmuff@hotmail.com

Attachments:

Run for the Roses Map 2012.pdf

COUNCIL ACTION FORM

SUBJECT: REQUESTS FOR “CRAFTS & DRAUGHTS IN CAMPUSTOWN”

BACKGROUND:

The Campustown Action Association (CAA) is planning to host its fourth annual Crafts and Draughts in Campustown on Saturday, September 7. Organizers propose hosting artists to facilitate crafts for all ages, food vendors, a beer garden, and live acoustic music in the 200 block of Welch Avenue from 1:00 p.m. to 6:00 p.m.

To facilitate this event, organizers are requesting the closure of Welch Avenue from Chamberlain Street to Hunt Street from 7:00 a.m. to 7:00 p.m. on September 7, including a waiver of fees and enforcement for 14 metered parking spaces (\$70 loss to the Parking Fund). CAA is also requesting a blanket Vending License and waiver of fee for the license (\$50), waiver of electricity costs for the use of City electrical outlets (approximately \$5 loss to the Electric Fund), and a blanket Temporary Obstruction Permit for the area.

A Class B Beer Permit with Outdoor Service has been applied for in order to provide alcoholic beverage service at the beer garden.

Public Works will provide barricades for the event. Organizers will obtain a noise permit from the Police Department. A private security firm has been hired for the event.

ALTERNATIVES:

1. Approve the requests as made by CAA, including the closure of Welch Avenue from Chamberlain Street to Hunt Street from 7:00 a.m. to 7:00 p.m. on September 7 and waive the fees for Vending License, electricity use, and lost parking meter revenue.
2. Approve the requests as made by CAA, but require reimbursement for Vending License, electricity use, and lost parking meter.
3. Do not approve the requests.

MANAGER’S RECOMMENDED ACTION:

Campustown Action Association has had a successful track record of hosting events. A private security firm has been hired to manage security for the beer garden. This proposed event is intended to be family-friendly and will take place primarily during daylight hours.

Therefore, it is the recommendation of the City Manager that the City Council adopt Alternative No. 1, thereby approving the requests as made by CAA, including the waiver of fees.



CITY OF

Ames SPECIAL EVENT APPLICATION

SUMMARY OF EVENT

DESCRIPTION

Event Name Crafts & Draughts in Campustown

Description

The Campustown Action Association will be hosting the 4th annual Crafts & Draughts in Campustown, focused on all ages including Alumni, Ames residents, ISU college students and parents. The event will be held Saturday, September 7th from 1 PM to 6 PM in the 200 block of Welch Avenue. CAA and staff from The Workspace will host craft tables for all ages and skill levels. There will also be a beer garden and live acoustic music. The event is free and open to the public.

Event Category

- Athletic/Recreation
- Exhibits/Misc.
- Festival/Celebration
- Parade/Procession/March
- Concert/Performance
- Farmer/Outdoor Market
- Other (please explain)

Anticipated Attendance

Total 750 Per Day _____

DATE/TIME

Setup	Date <u>9/7/2019</u>	Time <u>7:00 AM</u>	Day of Week <u>Saturday</u>
Event Starts	Date <u>9/7/2019</u>	Time <u>1:00 PM</u>	Day of Week <u>Saturday</u>
Event Ends	Date <u>9/7/2019</u>	Time <u>6:00 PM</u>	Day of Week <u>Saturday</u>
Teardown Complete	Date <u>9/7/2019</u>	Time <u>7:00 PM</u>	Day of Week <u>Saturday</u>

Rain Date, if applicable _____

Rain Location, if applicable _____

LOCATION

- Region**
(Select one or more)
- Main Street Cultural District (Downtown)
 - Campustown District
 - Iowa State University Property
 - City Parks
 - Other (please explain): _____

Please note that events occurring in the Downtown, Campustown, in City parks, or on ISU property require prior approvals. A letter of support will be required from CAA if the event occurs in Campustown or from MSCD if the event occurs in Downtown. Please contact the appropriate office well in advance.

Downtown - Main Street Cultural District: (515) 233-3472 events@amesdowntown.org
Campustown - Campustown Action Association: (515) 450-8771 director@amescampustown.com
Iowa State University - Events Authorization Committee: (515) 294-1437 eventauthorization@iastate.edu

CONTACTS Campustown Action Association

Host Organization

Local Contact *(Required)* **Name** Karin Chitty

Address 119 Stanton Ave. #602

Telephone 515-292-4528

Cell Phone 515-451-7503

Email karin.chitty@amescampustown.com

At least ten business days prior to the event, Organizer must submit Emergency Contact List, including names and numbers of all coordinators, volunteers, and location assigned to each.

Yes No

- Is this an annual event? How many years have you been holding this event? _
- Is this event open to the public?
- Is your event being held in conjunction with another event (e.g. *Farmers' Market, 4th of July, etc.*)?

If yes, please list



campustown
action
association

Campustown Action Association
119 Stanton Ave, Suite 602
Ames, IA 50014

August 5, 2019

Honorable Mayor Haila and City Council
Ames City Hall
515 Clark Avenue
Ames, IA 50010

RE: Crafts & Draughts 2019

Dear Honorable Mayor Haila and City Council,

The Campustown Action Association (CAA) is planning to hold the 4th annual Crafts & Draughts in Campustown on Saturday, September 7, 2019 from 1-6pm. C&D is a free event, which is open to the public, and a great way to encourage community members to visit Campustown. Additional information about the event can be found on the Special Event Application we submitted to the City of Ames staff. We are asking for resolutions approving the waiver of electricity costs for the 200 block of Welch Avenue, the waiver of parking meter fees for the indicated area of Welch from 7am – 7pm, and a waiver of fee for the Blanket Vendor Permit.

Thank you for your consideration of these requests and continued support of Campustown. We hope to see you on September 7th.

Sincerely,

Karin Chitty
Executive Director

Applicant License Application ()

Name of Applicant: <u>A&R Marketing, Inc</u>		
Name of Business (DBA): <u>A&R Marketing, Inc</u>		
Address of Premises: <u>217 Welch Ave</u>		
City <u>Ames</u>	County: <u>Story</u>	Zip: <u>50014</u>
Business <u>(515) 296-4651</u>		
Mailing <u>217 Welch Ave</u>		
City <u>Ames</u>	State <u>IA</u>	Zip: <u>50014</u>

Contact Person

Name <u>Anne Taylor</u>	
Phone: <u>(515) 290-6487</u>	Email <u>anne@dogtownu.com</u>

Classification Class B Beer (BB) (Includes Wine Coolers)

Term: 5 days

Effective Date: 09/07/2019

Expiration Date: 01/01/1900

Privileges:

Class B Beer (BB) (Includes Wine Coolers)

Outdoor Service

Status of Business

BusinessType: <u>Privately Held Corporation</u>	
Corporate ID Number: <u>XXXXXXXXXX</u>	Federal Employer ID <u>XXXXXXXXXX</u>

Ownership

Anne Taylor

First Name: Anne **Last Name:** Taylor
City: Ames **State:** Iowa **Zip:** 50014
Position: Co-Owner
% of Ownership: 50.00% **U.S. Citizen:** Yes

Roger Ossian

First Name: Roger **Last Name:** Ossian
City: Huxley **State:** Iowa **Zip:** 50124
Position: Co-Owner
% of Ownership: 50.00% **U.S. Citizen:** Yes

Insurance Company Information

Insurance Company: <u>Illinois Union Insurance Company</u>

Policy Effective Date: 09/07/2019

Policy Expiration 09/12/2019

Bond Effective

Dram Cancel Date:

Outdoor Service Effective

Outdoor Service Expiration

Temp Transfer Effective

Temp Transfer Expiration Date:

COUNCIL ACTION FORM

**SUBJECT: **AMENDMENT TO ELECTRIC SERVICES NATURAL GAS
SUPPLY CONTRACT****

BACKGROUND:

On October 15, 2015, a 5 year fixed price contract was awarded to Macquarie Energy LLC for for the purchase of 12,000 MMBtu/per day of natural gas for Electric Services for the contract period. The Power Plant typically burns 12,000 MMBtu of natural gas daily along with refuse-derived-fuel to generate electricity.

The contract has created efficiency and flexibility in the purchase of a valuable commodity, ensuring that the City has reliable service while creating stable generation costs.

Ames staff, in consultation with our NG consultant, have determined that this as a prudent time to secure a price and add two to three years of supply to the existing contract.

Here are the points of consideration that helped us make this recommendation:

- In late 2020 huge increases of Liquefied Natural Gas (LNG) exports to Asia and increased gas delivered to Mexico are expected. Mexico is forecasted to have a shortage by the end of 2019.

Production is expecting to ramp up in late 2020 or early 2021. However, this will be tempered by the above increase in exports along with increases in industrial load in the US.

- Most production has flattened. The one area where production continues to grow is the Northeast. However, there is not the required infrastructure to ship the product to the Midwest.
- There is an ongoing issue with adequately refilling storage which can cause volatile swings in the winter as current production and infrastructure cannot handle a true winter load.
- LNG will start to ramp up in late 2019 creating a short-term shortage of supply as production is currently not ready for this increase.
- Currently there are seven LNG ports operating, another ten will be approved and operating before the end of 2019. The total capacity of these seventeen locations

will be 32,500 MMBtu per day or 12 Billion Cubic Feet (BCF) annually. The second phase of LNG plants will be in service before the end of 2022 which adds another 9 BCF to this process.

The challenge in arranging a contract extension is to determine the price. In the natural gas market, it is not possible to ask for a price today, and have that price guaranteed for 5 days. The price expires within a 24-hour period. Case in point, when we negotiated the current contract price, the Council Action Form did not have prices nor did it identify the preferred supplier. Bidders faxed their prices to staff hours before the City Council meeting and a summary report was handed out during the council meeting where a decision was made.

In order to solve this problem for the contract extension, staff proposes the following. The current contract has a fixed price for natural gas set at \$3.02 per MMBtu. Forward price curves, for two years out, show natural gas futures in the \$2.80 - \$2.85 MMBtu range. **As these prices fluctuate between Council meetings, staff is requesting the authority to commit the City to a two or three-year extension if/when the overall cost reaches \$2.80/MMBtu or less.**

The approved FY 2019/20 operating budget currently includes \$13,200,000 for the purchase of natural gas to operate the power plant.

ALTERNATIVES:

1. Grant the Director of Electric Services the authority to approve an amendment with Macquarie Energy LLC, Houston, TX to extend the existing contract two or three years, if the overall contract cost falls to or below \$2.80/MMBtu.
2. Reject the amendment and maintain the existing contract with Macquarie Energy which expires on December 31, 2020.

MANAGER'S RECOMMENDED ACTION:

This strategy will continue to offer the City certainty in the supply and price of natural gas needed to operate the Power Plant and burn refuse derived fuel. The proposed amendment would drop the price, including the price of the current contract, by at least \$0.22 cents per MMBtu. This would save the City nearly \$80,000 per month under the current contract.

Therefore, it is the recommendation of the City Manager that the City Council adopt Alternative No. 1, as stated above.

COUNCIL ACTION FORM

SUBJECT: **BROOKSIDE PARK RESTROOM
RENOVATION PLANS & SPECIFICATIONS**

BACKGROUND:

The Brookside Park restroom building was constructed in the 1930s as a Civilian Conservation Corps (CCC) project and over the years, it has served as the Parks Maintenance Facility and, most recently, as the park restroom. On May 5, 2018, a fire started in a garbage can under the building's overhang and caused approximately \$50,000 in damage.

At its September 25, 2018 meeting, the City Council approved eliminating the current male and female restrooms and replacing them with four gender neutral, ADA compliant restrooms. The roof will be rebuilt and the shingles replaced with a brown metal roof. Skylights for each restroom will be added to allow daylight and reduce the need for lights to be on during the day. Infrared occupancy sensors are to be installed and will turn on lights based on body temperature. This feature will serve multiple purposes as it will not only turn on the lights when needed, the lights will stay on as long as someone is in there and will illuminate the dome on the skylight. If this happens outside of park hours, the lit dome will be an indicator for Police to check the restroom while they are on patrol. In addition, a door will be added to the south side to access the mechanical room. The picture below illustrates what the renovated restroom will look like.



ISG, Des Moines, Iowa, was hired to develop plans and specifications, prepare a cost estimate, and provide project management for this project. The engineer's cost estimate for the restroom renovation project which includes a 10% contingency is shown below:

Engineer's Estimate:	Amount
Restroom Renovation	\$199,788
Building Assessment (after fire)	2,068
Engineering	21,750
Total Estimate	\$223,606

At its September 25, 2018 meeting, City Council approved the use of funding from various CIP projects (shown below) for a total of \$219,706 to be used for this project.

Funding Source	Amount
Brookside Park Restroom Project (less 2016 design fees)	\$ 69,080
Insurance Payment	24,804
South River Valley Shelter Savings	1,242
Auditorium Sound Shell Savings	15,830
Furman Aquatic Center Painting Projects Savings	3,750
Ames High Tennis Court Repairs	25,000
North River Valley Park Restroom Renovation	30,000
ADA Transition Projects	50,000
Total	\$219,706

With the Engineer's estimate of \$223,606 and identified funding of \$219,706, there is a funding shortfall of \$3,900. The Brookside Park Path Lighting Project is complete and has savings of \$10,425 that can be used for the restroom renovation project.

ALTERNATIVES:

1. Approve the:
 - a. Plans and Specifications for the Brookside Park Restroom Renovation Project and set the bid due date for September 25, 2019, and October 8, 2019, as the date of hearing and award of the contract; and
 - b. Use of \$3,900 of savings from the completed Brookside Park Path Lighting Project as described above for the Brookside Restroom Project.
2. Do not approve the plans and specifications at this time, delaying the Brookside Park Restroom Renovation Project.
3. Refer back to staff.

CITY MANAGER'S RECOMMENDED ACTION:

The Parks Master Plan indicates permanent restrooms are an amenity to be located in community parks. Since Brookside Park is a community park, it is reasonable to renovate

the current restroom. **Renovating the current restroom facility and adding four gender neutral restrooms that meet ADA requirements is a way to provide restrooms that can be used by the wide diversity of park users and complete the project with the available funding. Therefore, it is the recommendation of the City Manager that the City Council approve Alternative #1 as stated above.**

COUNCIL ACTION FORM

SUBJECT: NOTICE TO BIDDERS FOR THE WATER POLLUTION CONTROL FACILITY METHANE ENGINE GENERATOR REPLACEMENT PROJECT

BACKGROUND:

In 2017, City Council accepted staff's recommendation of replacing one of the methane engine generators with a dual fuel boiler; primarily to provide a backup heating system for the digesters, but also because of a potential decrease in maintenance costs. The installation of a new boiler also includes piping and control upgrades. Based on Council's direction, funds were designated in the Capital Improvements Plan to address the methane engine generators.

The City Council has previously awarded a contract for engineering services to Strand Associates, Inc. of Madison, Wisconsin, for design, bidding, and construction of the Water Pollution Control Facility (WPCF) Methane Engine Generator Replacement Project in a total amount not to exceed \$254,200. The final design is now complete and staff is ready to issue a notice to bidders.

The engineer's estimate of probable construction costs is \$1,250,000. The FY 18/19 budget includes \$1,515,000 for design and construction of the replacement of Methane Engine No. 1 with a boiler. **The currently authorized budget is sufficient to cover the engineering plus the estimated construction costs, but leaves only a very small contingency. In order to provide contingency funds, Staff intends to redirect \$325,000 in savings from the completed Structural Rehabilitation Project to this Methane Engine Generator Replacement Project during the early budget amendments.** Once these funds are redirected, the project budget and authorized funding would be as follows:

Project Budget

FY 18/19 CIP	\$ 1,515,000
Savings from Structural Rehabilitation	325,000
<hr/>	
Total Available Funding	\$ 1,840,000

Estimated Project Expenses

Engineering	
Design	\$ 165,000
Bidding and Construction	89,200
Construction Estimate	1,250,000
<u>Contingency (25% of construction)</u>	<u>312,500</u>
Total Estimated Expense	\$ 1,816,700

ALTERNATIVES:

1. Grant preliminary approval of the plans and specifications and issue a notice to bidders for the Methane Engine Generator Replacement Project, setting September 25, 2019 as the bid due date and October 8, 2019 as the date of public hearing.
2. Do not issue a notice to bidders at this time.

CITY MANAGER'S RECOMMENDED ACTION:

The Water Pollution Control Facility's original two methane engines are almost 30 years old. Replacement of this equipment is necessary to maintain the integrity of the treatment facility and to continue to burn methane that is generated by the treatment process. At a previous meeting, the City Council gave staff direction to move forward with replacing one of the original methane engines with a dual fuel boiler. Staff has reviewed the design of this project and obtained a construction permit from the IDNR to perform the work. The next step for this project is to solicit bids. Therefore, it is the recommendation of the City Manager that the City Council adopt Alternative No. 1, as described above.

COUNCIL ACTION FORM

SUBJECT: **ELECTRIC SERVICES FUEL SUPPLY CONTRACT**

BACKGROUND:

This contract is for the purchase of #2 ultra low sulfur diesel fuel for Electric Services. The utility has a 250,000-gallon main fuel tank located at the Dayton Substation to fuel the two GT (gas-turbine) units. The Utility's two gas-turbines could burn 250,000 gallons of fuel in a 60 hour time period, requiring larger refill volumes and quick refills should an emergency dictate that they stay on-line.

The scope of work for this contract includes supplying fuel to gas turbines units as needed. Suppliers were asked to provide pricing based in the form of a markup to the daily-published "rack" average fuel price at the Des Moines, Iowa, terminal for stated products.

This contract is to supply #2 ultra low sulfur diesel fuel to Electric Services for the period from August 28, 2019 through June 30, 2020. The contract includes a provision that would allow the City to renew the contract for up to four additional one-year terms.

The goal of the contract is to create efficiency and flexibility in the purchase of a valuable commodity, ensuring that the City is able to use opportunity purchasing and to lock in performance criteria for the suppliers.

On August 1, 2019, bid documents were issued to sixteen companies. The bid was advertised on the Current Bid Opportunities section of the Purchasing webpage and a legal notice was published in the Ames Tribune. The bid was also sent to one plan room.

On August 21, 2019, 3 bids were received as shown on the attached report. Staff has reviewed the bids and concluded that the apparent low bid submitted by Diamond Oil, in the amount of (-\$0.0062) deduct off of the Magellan "rack" fuel price, and in the amount of \$0.0163 increase off of the Buckeye "rack" fuel price is acceptable. Magellan and Buckeye are two fueling terminals. Buckeye tends to have a more consistent and better fuel quality, which makes it the preferred terminal. However, if delivery is unavailable from Buckeye, having Magellan as an alternative is a necessity.

Council should note that actual cost invoices will be based on the amount of fuel purchased and the price of the fuel at the time of purchase. The total cost of fuel purchased under this contract based on typical usage is estimated to be

\$140,659.80. The approved FY 2019/20 operating budget includes \$150,000 for this fuel purchase.

ALTERNATIVES:

1. Award a contract for supplying diesel fuel to the City's gas turbine units to Diamond Oil, in the amount of (-\$0.0062) deduct off of the Magellan "rack" fuel price, and in the amount of \$0.0163 increase off of the Buckeye "rack" fuel price with a total amount not-to-exceed \$150,000. The contract includes a provision that would allow the City to renew the contract for up to four additional one-year terms.
2. Award a contract to one of the other bidders.
3. Reject all bids and purchase fuel on daily bids.

MANAGER'S RECOMMENDED ACTION:

This contract will offer the City the ability to have flexibility in fuel purchasing and to maintain standards of performance for fuel content and fuel delivery. Detailed ordering and delivery procedures will also be part of this contract.

Therefore, it is the recommendation of the City Manager that the City Council adopt Alternative No. 1 as stated above.

CITY OF AMES, IOWA									
Ph: 515-239-5125 * Fax: 515-239-5325 Mike Adair, Procurement Specialist II									
Bid No. 2020-012		Magellan Terminal ULSD #2 (Add +)	Magellan Terminal ULSD #2 (Subtract -)	Buckeye Terminal ULSD #2 (Add +)	Buckeye Terminal ULSD #2 (Subtract -)	** Estimated Price Per Truckload (Magellan)	** Estimated Price Per Truckload (Buckeye)	Estimated Annual Cost [Based on Ten (10) Transport Loads] Magellan	Estimated Annual Cost [Based on Ten (10) Transport Loads] Buckeye
#2 Diesel Fuel Supply Contract City of Ames Power Plant									
BIDDERS									
Diamond Oil			\$0.0062	\$0.0163		\$13,899.42	\$14,065.92	\$138,994.20	\$140,659.20
Petroleum Traders Corp		\$0.0292		\$0.0367		\$14,161.38	\$14,216.88	\$141,613.80	\$142,168.80
Keck Energy		\$0.0310		\$0.0610		\$14,174.70	\$14,396.70	\$141,747.00	\$143,967.00
** Based on a transport load of 7,400 gallons and \$1.8845/Gallon.									
Price per gallon on 8/21/19. Per Iowa DOT website for #2 ULSD.									

CITY OF AMES, IOWA				
Ph: 515-239-5125 * Fax: 515-239-5325 Mike Adair, Procurement Specialist II				
Bid No. 2020-012				
#2 Diesel Fuel Supply Contract City of Ames Power Plant	Contract Period (7/1/20 - 6/30/21) Percentage Increase	Contract Period (7/1/20 - 6/30/21) Percentage Increase	Contract Period (7/1/20 - 6/30/21) Percentage Increase	Contract Period (7/1/20 - 6/30/21) Percentage Increase
BIDDERS				
Diamond Oil	0.00%	0.00%	0.00%	0.00%
Petroleum Traders Corp	0.00%	0.00%	10.00%	15.00%
Keck Energy	5.00%	5.00%	5.00%	5.00%

COUNCIL ACTION FORM

SUBJECT: **AWARD OF CONTRACT FOR CYRIDE
RADIO EQUIPMENT AND SERVICES**

BACKGROUND:

CyRide radio equipment is currently provided by Electronic Engineering Co. under the terms and conditions of the lease contract extended by Council on June 25, 2019. Radio equipment furnished under the contract includes portable and vehicle radios, base station radios, antennas and other related equipment. The total annual cost for radio equipment is approximately \$65,350 per year.

Local emergency responders occasionally call on CyRide to assist during times of crisis. CyRide buses are used to shelter and transport people during emergencies. The existing radio system is not compatible with the City of Ames and Story County's planned new P25 emergency communication system. CyRide wishes to join other City of Ames departments in the purchase of the new system so that critical communication is maintained during emergencies. The new radio system will also be an improvement over the existing system when used for routine daily communications between buses and base.

In the FY19-20 Capital Improvement Plan (CIP), CyRide budgeted \$150,000 for radio replacement under the assumption that a lease option would be available. In February 2019, the City of Ames radio project manager informed staff that a lease option would not be part of the agreement between StoryComm and RACOM. A project budget of \$320,000 was developed based on preliminary pricing. This left a capital shortfall of \$170,000. In June 2019, it was announced that CyRide would be the recipient of a VW Settlement Grant award in the amount of \$170,640. The VW award could only be used for the purchase of new transit buses. Staff had been working on a new bus order which required a 15% local match. The Transit Board approved reallocating \$170,640 that was going to be used as the local match for the purchase of new buses to the new radio system at their June 13, 2019 meeting.

Following the June Board action, it was discovered that the actual purchase price for the system would be \$341,145. The extra \$21,146 in the cost of the project was due to pricing errors. CyRide staff was able to identify \$25,000 in the FY19 capital budget that was not spent. These funds were rolled into the FY20 budget. Because of the frequency of pricing changes that had been occurring, the Transit Board approved using up to \$25,000 in unallocated capital carried over from FY19 to purchase the radio system at their August 8, 2019 meeting. The City of Ames Legal Department has reviewed the RACOM agreement.

In summary, the breakdown of the funding for the radio system is as follows:

FY20 Budgeted Funds	\$ 150,000
FY20 Re-allocated Capital Funds	\$ 170,640
FY19 Unspent Capital Funds	<u>\$ 25,000</u>
	\$ 345,640
Less the Final Cost of Radio System	\$ 341,145
Potential Available Funding Overage	\$ 4,495

ALTERNATIVES:

1. Award contract to RACOM Critical Communications of Marshalltown, IA in the amount of \$341,146 for the purchase of a new radio system for CyRide.
2. Reject the proposed contract and direct staff to modify the project to reflect other Council priorities.

MANAGER'S RECOMMENDED ACTION:

Award of contract to RACOM Critical Communications of Marshalltown, IA will allow CyRide to replace the existing outdated radio system. Installation of a new system will enable CyRide to improve daily communications and enable critical communication with first responders during emergencies. The contract award of \$341,146 includes radio hardware and associated equipment installation.

Therefore, it is the recommendation of the City Manager that the City Council adopt Alternative No. 1 as stated above.

COUNCIL ACTION FORM

SUBJECT: **MAINTENANCE MANAGEMENT SOFTWARE UPDATE FOR
POWER PLANT**

BACKGROUND:

The Power Plant uses a Computerized Maintenance Management Software (CMMS) system called MP2. The CMMS is the backbone of the plant's maintenance program, tracking asset health, maintenance records, work orders, and inventory and it is crucial to have an up-to-date system to assure power plant reliability and efficiency. MP2 is no longer a supported system and the latest version does not meet the needs of the Power Plant. It does not allow employees to easily access the work orders assigned to them, cannot be accessed via mobile devices, and is not user-friendly for the plant employees.

City staff sought proposals from three companies for both software-as-a-service (SAAS) and purchased software. Infor, New York, NY, was the only company that offered a purchased software; therefore, staff evaluated a total of four proposals, indicated below:

VENDOR	SOFTWARE TYPE	3 - YEAR TOTAL PRICE
Limble CMMS, Lehi, UT	SAAS	\$68,796.00
eMaint, Bonita Springs, FL	SAAS	\$94,360.00
Infor, New York, New York	SAAS	\$159,544.00
Infor, New York, New York	Purchased Software	\$169,606.30

The lowest cost proposal, for a SAAS solution provided by Limble CMMS, Lehi, Utah, is an acceptable solution. This product allows all plant employees to have easy, mobile access to all inventory, parts, work requests, and preventative maintenance tasks. The cloud based system allows software updates to be administered automatically, meaning the Power Plant will always have the most up-to-date version. Besides access to the software, the annual price covers set up, maintenance fees, data backup, and instant customer support. The most crucial features the Power Plant needs in a CMMS are inventory management, work order capabilities, plant status quick view, usability, and scheduling abilities.

The FY 2018/19 Power Plant maintenance budget included \$150,000 for the purchase of this software. Plant staff was unable to complete this task in FY2018/19 and is planning to carry this funding over to the 2019/20 fiscal year.

The City Council is being asked to approve a three-year agreement for \$68,796.00 at this time, rather than a one-year contract with renewal options. It should be noted

that this contract includes a reduced rate of 20% off list price since it is for three years.

A separate project will be undertaken to review the current inventory data and bring it up-to-date. Once updated data is obtained, it will be entered into this new CMMS for plant staff's use. City staff is currently seeking information regarding the costs to conduct this update, and the City Council may be requested to provide approval for that project in the next several weeks.

ALTERNATIVES:

1. Award a three-year contract for Computerized Maintenance Management Software to Limble CMMS, Lehi, Utah in the amount of \$68,796.
2. Award a contract to one of the other bidders.
3. Do not approve the three-year contract.

CITY MANAGER'S RECOMMENDED ACTION:

A modern CMMS is essential to provide Power Plant staff access to important data regarding the equipment and assets in the plant's inventory. The proposed contract provides for a versatile product that will assist plant staff in managing the facility and equipment.

Therefore, it is the recommendation of the City Manager that the City Council adopt Alternative No. 1 as stated above.



MEMO

To: Mayor and Members of the City Council

From: City Clerk's Office

Date: August 27, 2019

Subject: Contract and Bond Approval

There is/are no Council Action Form(s) for Item No(s). 27, 28, 29, 30, and 31. Council approval of the contract and bond for this/these project(s) is simply fulfilling a *State Code* requirement.

/alc

COUNCIL ACTION FORM

SUBJECT: CHANGE ORDER NO. 5 - UNIT 7 BOILER REPAIR PROJECT

BACKGROUND:

On March 26, 2019, the City Council approved the award of a contract to Helfrich Brothers Boiler Works, Inc. of Lawrence, MA, in the amount of \$6,376,685 for the Unit 7 Boiler Repair Project. This project is to repair the boiler through the following actions:

- Replacing the boiler tubes in the lower water wall section of the boiler. This includes the bottom 50' of tubes on all four sides of the boiler.
- Replacing all the pendant tubes in the superheat section
- Reinsulating the steam and mud drums
- Replacing the insulation and lagging (the aluminum skin) that covers the entire boiler

After switching from coal to natural gas two years ago, staff found that the boiler tubes, especially the superheater tubes, were deteriorating at an accelerated rate. The water vapor created during the combustion of natural gas combines with the chlorides and acid gases from combusting refuse-derived fuel (RDF). This causes the tube surfaces to corrode very quickly, especially in the high temperature zones of the superheater.

The existing tubes and insulation and lagging are original to the boiler, built in 1967. The replacement tubes will be coated with Inconel, an alloy that is resistant to the kind of corrosion created from combusting RDF and natural gas.

CHANGE ORDER HISTORY:

Four change orders were previously issued for this contract. Change Order 1, in the amount of \$233,260, was approved by the City Council on May 14, 2019. This change order was to change subcontractors because of concerns City staff had with the subcontractor Helfrich initially proposed to apply the Inconel cladding. These concerns related to the equipment and the process the subcontractor was going to use to apply the Inconel cladding to the tubes, plus concerns about quality control and the subcontractor's staff's training and experience.

Change Order 2, in the amount of \$22,951.50, was to perform nondestructive testing on the generating bank tubes to determine their condition. The generating bank is composed of 1,426 tubes that go between the steam drum and mud drum, located at the top of the boiler. The current Unit 7 capital project allowed for opportunity to examine these generating bank tubes, which was not part of the base contract. This change order was approved by staff.

Change Order 3, in the amount of \$18,931.40, was to install additional scaffolding in the upper furnace section to accommodate ultrasonic testing and to also remove the lower air seals at the bottom of the boiler. This change order was approved by staff.

Change Order 4, in the amount of \$761,733, was approved by City Council on July 16, 2019. This change order was to replace 269 thin tubes found in the generating bank with new tubes, 186 of them were to contain Inconel 625 weld overlay. Helfrich was to replace an additional 2-3' of all tubes on the front and back walls at the bottom of the boiler with new tubes without overlay. Helfrich was also to replace all tube stubs coming from both lower side wall headers with new 8-inch stubs that will have 5 inches of Inconel 625 weld overlay at .070 thickness.

THIS ACTION:

At the time Change Order 4 was presented for City Council approval, the staff report indicated that additional change orders were being evaluated in regard to four areas of concern. These areas were:

- Header and structural support integrity with the additional weight of the Inconel overlay
- Air plenum to direct over-grate air
- Bottom ash hopper and air seal
- Refractory repair

The proposed Change Order 5 presented for City Council consideration addresses the first three of these areas, plus an additional repair that was not previously described to the City Council.

HEADER AND STRUCTURAL SUPPORT INTEGRITY – The first item, for a total of **\$65,043**, is responding to the engineering study performed to evaluate the effect of the additional weight of the Inconel overly tubes upon the connections and the effect upon the integrity of headers and the structural supports of the boiler. Although conducting this study was a requirement of the original bid specification, the modifications needed to address the study outcome were not included in the bid specification.

In response to the study, Helfrich will supply and install three (3) additional Front Waterwall hanger lugs, Hanger Rod Assemblies, and modify the existing back to back channels. Pricing includes engineering design of the placement of the hanger lugs and reinforcement of the existing channels, installation of the new hanger lug plates to the front waterwall tubes in the penthouse, and installation of the additional reinforcement plates on the existing channels the hanger rods hang from.

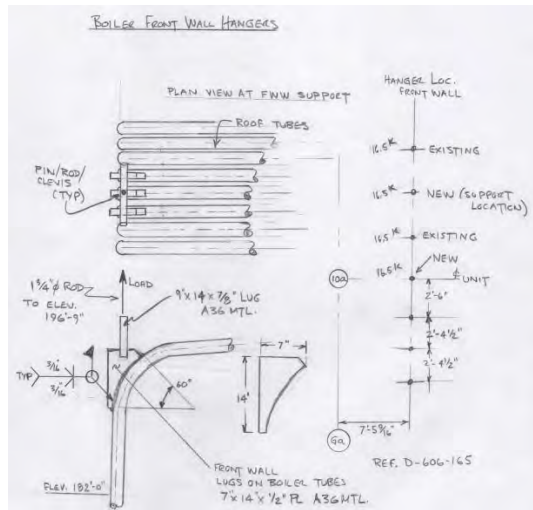

Figure 1: Boiler Front Wall Hangers

AIR PLENUM TO DIRECT OVER-GRATE AIR – The second item, for a total of **\$49,950**, is installing an enclosed air chamber at the bottom of the boiler to better direct over grate air. As demolition was being performed in the beginning of the tube replacement project, the existing system showed evidence of significant air leaks.

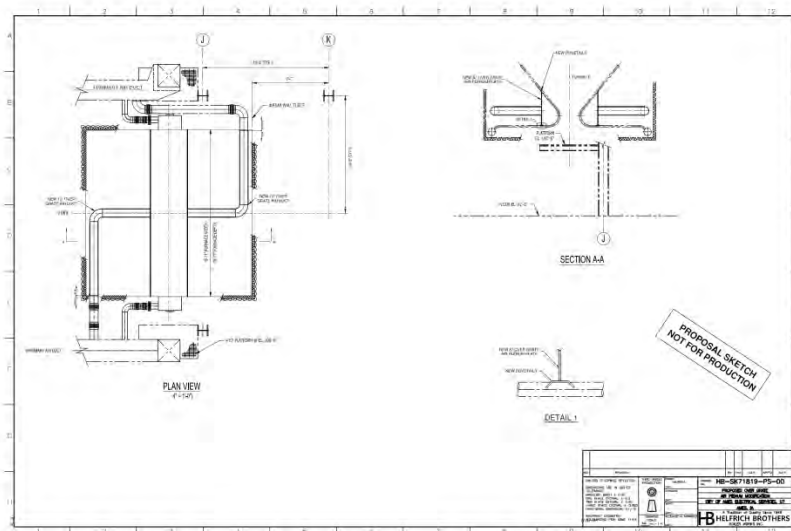
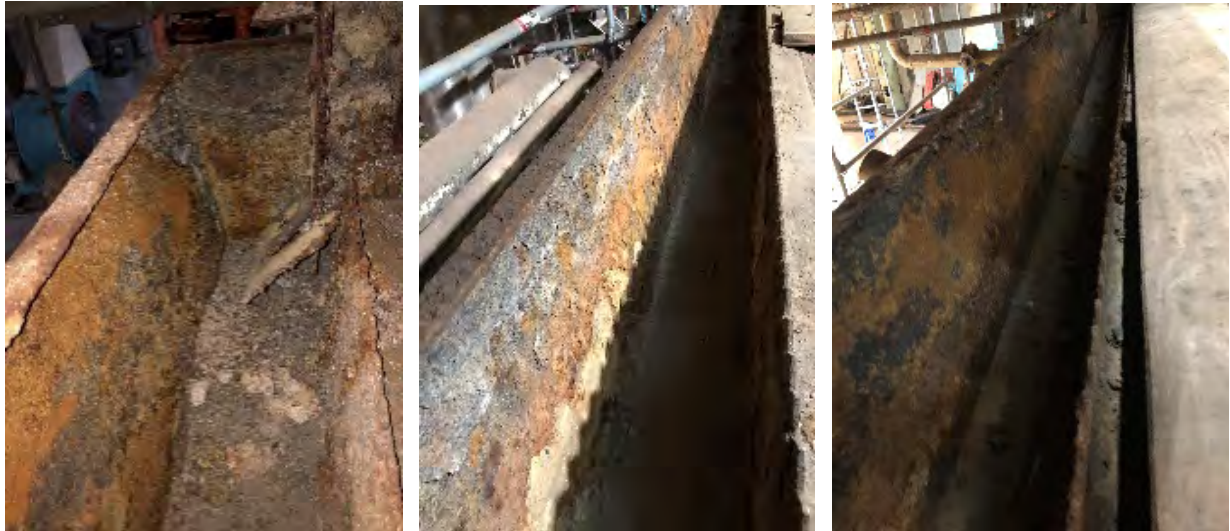

Figure 2: Over Grate Air Plenum Design

Helfrich will supply and install a new Over Grate Air Plenum (enclosed air chamber) that will direct all combustion air to the top surface of the grate. This will help complete combustion of the RDF on the grates and greatly minimize air in leakage.

BOTTOM ASH HOPPER AND AIR SEAL – The third item, for a total of **\$228,700**, is to replace the seal trough and air seal around the top of the bottom ash hopper. The condition of the seal trough and air seal was not fully known until performing demolition at the beginning of the project, allowing for staff to thoroughly inspect it.



Helfrich will supply and install a new, 304 stainless steel water seal trough, 316 stainless steel saw tooth wear plate, 309 stainless steel baffle, scallop tube, air seals with gaskets and hardware, and W8 and C11 stiffeners. The replacement will involve removing and replacing a 2-foot band of 9-inch thick refractory around the entire perimeter of the bottom ash hopper.

ADDITIONAL ITEM: SCREEN TUBE REPLACEMENT – The final component of this proposed change order, for a total of **\$84,370**, is to replace 26 screen tubes in the top of the boiler. The screen tubes travel from the back water wall and go into the steam drum, bypassing the mud drum and generating bank.

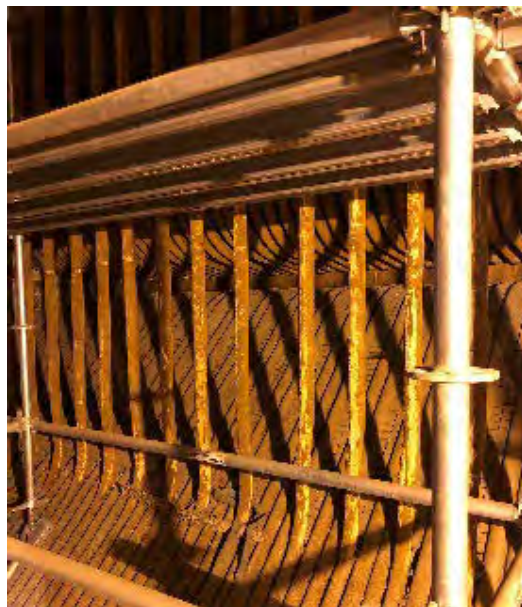

These tubes are normally shielded to protect them during sootblower cleaning. Upon

inspection, the shielding was found to be in total disrepair or missing all together. Instead of trying to replace the shielding and keep them maintained, the replacement tubes will be overlaid with Inconel 625, providing for adequate protection from future sootblowing.

Although the July 26th Council Action Form indicated that staff anticipated needing a change order to address repairs to worn or missing refractory on the original waterwall tubes left in the boiler, City staff needs to have further discussions with the contractor regarding this item. Aside from this item, City staff is also evaluating additional proposed changes. Staff anticipates further change orders, potentially requiring City Council approval, will be required in the coming weeks.

Therefore, the action being requested at this time is to approve Change Order No. 5. This change order will add an additional \$458,027.41, inclusive of \$29,964.41 in sales tax, to the current contract. This will bring the total contract amount to \$7,871,588.31. With the engineer's estimate of \$8,400,000 for this project, the low bid plus the change orders is \$528,411.69 less than the engineer's estimate.

The FY 2019/20 Capital Improvements Plan (CIP) includes the following funding for the Unit No. 7 Boiler Repair Project:

2015/16 Engineering	\$5,150
2016/17 Engineering	\$125,796
2017/18 Engineering	\$50,000
2019/20 Materials/labor superheat and waterwalls	\$8,400,000
TOTAL	<u>\$8,580,946</u>

ALTERNATIVES:

1. Approve Change Order No. 5 in the amount of \$458,027.41 (inclusive of sales tax) to Helfrich Brothers Boiler Works, Inc., of Lawrence, MA, for the Unit 7 Boiler Repair Project.
2. Do not approve Change Order #5.

CITY MANAGER'S RECOMMENDED ACTION:

This project will go to great lengths to address Unit 7's boiler tube failures. It is crucial that the project proceed as soon as possible in order to minimize downtime for this boiler and to increase the Power Plant's availability and reliability.

Therefore, it is the recommendation of the City Manager that the City Council adopt Alternative No. 1, as described above.



Public Works Department
515 Clark Avenue, Ames, Iowa 50010
Phone 515-239-5160 ♦ Fax 515-239-5404

August 27, 2019

Item No. 33

Honorable Mayor and Council Members
City of Ames
Ames, Iowa 50010

RE: Wessex Subdivision Financial Security Reduction - Final

Ladies and Gentlemen:

I hereby certify that the conditions for approval of the final plat of **Wessex Subdivision** have been fulfilled. As a result of this certification, it is recommended that the financial security on file with the City for this subdivision be released in full.

Sincerely,

John C. Joiner, P.E.
Director

JJ/nw

cc: Finance, Planning & Housing, Subdivision file

COUNCIL ACTION FORM

**SUBJECT: COMPLETION OF CONTRACT FOR THE RIVER VALLEY PARK
SOFTBALL INFIELD RENOVATION PROJECT**

BACKGROUND:

This project included renovation of six softball infields in River Valley Park. Four fields are located in North River Valley Park at 1015 E. 13th Street, and two fields are located in South River Valley Park at 1200 E. 13th Street. The project included removal of existing infield material, relocation of irrigation lines, and installation of new infield material to specified depths. The project was awarded to Iowa Cubs Sports Turf Management, Des Moines, IA, on April 11, 2017 in the amount of \$108,900.

The original project scope included replacing the existing drainage and adding new, but it was mutually agreed upon by the City of Ames, Bolton & Menk, and Iowa Cubs Sports Turf Management that the drainage was working fine and didn't need to be replaced. Iowa Cubs Sports Turf Management reduced the overall construction cost by \$7,850 to \$101,050.

The project was expected to be completed the spring of 2018, but after further review, the infield material contained rocks that were larger than what was acceptable. This past spring, the contractor sifted all six infields and removed the rocks over a quarter of an inch in size. Attached is a letter from Bolton & Menk, confirming the project is complete.

The total project cost with engineering and design was \$122,375, while the amount budgeted was \$140,000.

ALTERNATIVES:

1. The City Council can:
 - a. Adopt a resolution approving Change Order #1 in the amount of (\$7,850) to Iowa Cubs Sports Turf Management, Des Moines, Iowa for the River Valley Park Softball Field Renovation Project; and
 - b. Adopt a resolution accepting completion of the contract for the River Valley Park Softball Field Renovation Project with Iowa Cubs Sports Turf Management, Des Moines, Iowa in the amount of \$101,050.

2. The City Council can decide not to accept the completion of the River Valley Park Softball Infield Project in the amount of \$101,050.

CITY MANAGER'S RECOMMENDED ACTION:

The softball fields have been a critical component of providing a quality recreation program. Therefore, over the last five years, many improvements have been made to these facilities. The infield renovation is the last step in providing a quality, safe experience for softball users.

Therefore, it is the recommendation of the City Manager that the City Council adopt Alternative No. 1, as stated above.



**BOLTON
& MENK**

Real People. Real Solutions.

1519 Baltimore Drive
Ames, IA 50010-8783

Ph: (515) 233-6100
Fax: (515) 233-4430
Bolton-Menk.com

August 22, 2019

Mr. Joshua Thompson
Parks and Facilities Superintendent
City of Ames Parks and Facilities
700 E. 13th Street
Ames, IA 50010

RE: N/S River Valley Park Softball Infield Renovation
City of Ames
Project No.: A13.112323

Dear Joshua:

Iowa Cubs Sports Turf Management has completed all work under the contract for the N/S River Valley Park Softball Infield Renovation Project; including punch list items identified by the City and Bolton & Menk at a walkthrough on December 8, 2017. The final remaining item on the punch list, removal of larger aggregate material in the infield field mix, was resolved to the satisfaction of the City earlier this summer. As Iowa Cubs Sports Turf Management has completed items of construction in substantial compliance with plans, specifications, contract documents, change orders and punch lists. It is the recommendation of Bolton & Menk that the project be accepted by the City.

Iowa Cubs Sports Turf was also able to expose the subdrain on each of the infields during construction and found these systems to be in good working order. This resulted in a deduct to the project in place of labor and subdrain material indicated on plans.

Sincerely,

Bolton & Menk, Inc.

JOSHUA SHIELDS
Joshua L. Shields, PLA
Project Manager

Cc (Casey Scheidel – Iowa Cubs Sports Turf Management)

COUNCIL ACTION FORM

SUBJECT: FIRE STATION #1 PARKING LOT RECONSTRUCTION

BACKGROUND:

When Fire Station #1 was constructed in 1979, underground fuel tanks were installed underneath the rear drive. The fuel tanks were removed, and the void was filled, but settling of the pavement has occurred, causing accelerated damage. Public Works engineers evaluated the concrete and agreed the lot needed to be replaced. The impervious area of this redevelopment is under one acre, thus post-construction stormwater requirements are not required.

On April 23, 2019 City Council awarded the construction contract to Manatt's Inc. of Ames, IA, in the amount of \$78,437.08. One change order was administratively processed for this project, increasing the contract by \$7,468.74, bringing the **final adjusted contract in an amount of \$85,905.82**. Change order No. 1 reflected the actual measured quantities completed during construction, additional joint sealing adjacent to the Fire Station building, and parking lot lighting restoration (the existing conduit, cables, and lighting was found to be corroded upon removal of the pavement).

Engineering, construction administration, Site Plan fees, and miscellaneous expenses (items to meet Site Plan approval including mulch, native vegetation, and fencing) are in the amount of \$20,500, bringing the **total project cost to \$106,405.82**. This project is shown in the 2018/19 Capital Improvements Plan programs with funding in the amount of \$137,000 in G.O. Bonds.

ALTERNATIVES:

1. Accept the Fire Station #1 Parking Lot Reconstruction project as completed by Manatt's Inc. of Ames, IA, in the amount of \$85,905.82.
2. Direct staff to pursue modifications to the project.

MANAGER'S RECOMMENDED ACTION:

Replacing this parking lot has provided a more stable pavement at Fire Station #1, thereby ensuring that no lot-related damage would occur to fire apparatus and thereby reducing maintenance costs. This project has been completed in accordance with the approved final plans and specifications.

Therefore, it is the recommendation of the City Manager that the City Council adopt Alternative No. 1 as described above.

COUNCIL ACTION FORM

SUBJECT: ACCEPT COMPLETION OF ASBESTOS MAINTENANCE FOR POWER PLANT CONTRACT FY 2014/15 THROUGH FY 2018/19

BACKGROUND:

On May 13, 2014, City Council awarded a contract to ESA, Inc., North Sioux City, SD, for Asbestos Maintenance for Power Plant for FY 2014/15. This contract involves the removal and proper disposal of asbestos insulation at the City's Power Plant, including Units 5 and 6 (both retired) and operating units 7 and 8. In addition, there is other equipment and piping located in the Power plant that has been insulated with asbestos-type insulation.

This contract had the option for the City to renew in one-year increments for up to four additional years. City Council approved each of those renewals. The final renewal period for this contract ended on June 30, 2019. All of the requirements of the contract have been met by ESA, Inc., and the Director of Electric Services has provided a certificate of completion.

Total award amounts, change orders, and the total spent each fiscal year under this contract are as follows:

Fiscal Year	Award Amount	Change Orders	Total Authorized Amount	Total Amount Spent	Unused Amount
2014/15	\$ 75,000.00	\$ 60,500.00	\$135,500.00	\$123,368.35	\$ 12,131.65
2015/16	150,000.00	-0-	150,000.00	37,693.95	112,306.05
2016/17	100,000.00	-0-	100,000.00	75,147.28	24,852.72
2017/18	80,000.00	15,000.00	95,000.00	88,882.88	6,117.12
2018/19	80,000.00	175,000.00	255,000.00	237,036.45	17,963.55
Total	\$485,000.00	\$250,500.00	\$735,500.00	\$562,128.91	\$173,371.09

ESA, Inc. has completed work under this contract and the Director of Electric Services has provided a certificate of completion.

ALTERNATIVES:

1. Accept completion of the contract under Invitation to Bid No. 2014-157 for Asbestos Maintenance Services for Power Plant FY2014/15 through FY 2018/19 with ESA, Inc., North Sioux City, SD, in the total amount of \$562,128.91.
2. Delay acceptance of this contract.

MANAGER'S RECOMMENDED ACTION:

ESA, Inc., the contractor for the Asbestos Maintenance Services for Power Plant for FY 2014/15 through FY 2018/19, has completed all work required under the contract. The Director of Electric Services has issued a certificate of completion for the work.

Therefore, it is the recommendation of the City Manager that the City Council adopt Alternative No. 1 as stated above.

COUNCIL ACTION FORM

**SUBJECT: ACCEPT COMPLETION OF BOILER MAINTENANCE SERVICES
 CONTRACT FOR POWER PLANT FY 2016/17 THROUGH FY 2018/19**

BACKGROUND:

On February 14, 2017, City Council awarded a contract to TEI Construction Services Inc., Duncan, SC, for Boiler Maintenance Services for Power Plant for the remainder of FY 2016/17. This contract consists of a variety of boiler and pressure vessel maintenance, including structural steel and pressure vessel repair. This consists of emergency service as well as planned repairs and services during scheduled outages. The initial contract period was shortened to enable future renewals to coincide with the City's fiscal year.

This contract had the option for the City to renew in one-year increments for up to four additional years. City Council approved renewals for FY 2017/18 and FY 2018/19. During FY 2018/19, the contractor struggled to provide needed manpower for short-term repairs and maintenance work under this contract. This situation was reported to City Council on April 16, 2019, and an emergency change order was authorized to an alternative vendor in order to complete necessary boiler repair work. On April 18, 2019, TEI Construction Services, Inc. was notified that the City would not be renewing this contract for FY 2019/20.

Total award amounts, change orders, and the total spent each fiscal year under this contract are as follows:

Fiscal Year	Award Amount	Change Orders	Total Authorized Amount	Total Amount Spent	Unused Amount
2016/17	\$200,000.00	\$ -0-	\$ 200,000.00	\$ 57,533.02	\$142,466.98
2017/18	210,000.00	1,080,000.00	1,290,000.00	1,261,347.43	28,652.57
2018/19	200,000.00	1,085,000.00	1,285,000.00	1,144,921.00	140,079.00
Total	\$610,000.00	\$2,165,000.00	\$2,775,000.00	\$2,463,801.45	\$311,198.55

TEI Construction Services, Inc. has completed work under this contract and the Director of Electric Services has provided a certificate of completion.

ALTERNATIVES:

1. Accept completion of the contract under Invitation to Bid No. 2017-073 for Boiler Maintenance Services for Power Plant FY 2016/17 through FY 2018/19 with TEI Construction Services, Inc., Duncan, SC, in the total amount of \$2,463,801.45.

2. Delay acceptance of this contract.

MANAGER'S RECOMMENDED ACTION:

TEI Construction Services, Inc., the contractor for Boiler Maintenance Services for Power Plant for FY 2016/17 through FY 2018/19, has completed all work required under the contract. The Director of Electric Services has issued a certificate of completion for the work.

Therefore, it is the recommendation of the City Manager that the City Council adopt Alternative No. 1 as stated above.

COUNCIL ACTION FORM

SUBJECT: ACCEPT COMPLETION OF NON-ASBESTOS INSULATION AND RELATED SERVICES CONTRACT FOR POWER PLANT FY 2014/15 THROUGH FY 2018/19

BACKGROUND:

On January 13, 2015, City Council awarded a contract to Total Insulation Mechanical, Inc. Story City Iowa, for Non-Asbestos Insulation and Related Services for Power Plant for the remainder of FY 2014/15. This contract involves the removal, repair, and reinstallation of non-asbestos insulation of all types used at the City's Power Plant. The initial contract period was shortened to enable future renewals to coincide with the City's fiscal year.

This contract had the option for the City to renew in one-year increments for up to four additional years. City Council approved each of those renewals. The final renewal period for this contract ended on June 30, 2019. Total authorized amounts and the total spent each fiscal year under this contract are as follows:

Fiscal Year	Award Amount	Total Amount Spent	Unused Amount
2014/15	\$ 90,000.00	\$ 19,080.72	\$ 70,919.28
2015/16	125,000.00	7,980.70	117,019.30
2016/17	100,000.00	94,583.55	5,416.45
2017/18	80,000.00	24,028.73	55,971.27
2018/19	80,000.00	36,902.26	43,097.74
Total	\$ 475,000.00	\$ 182,575.96	\$ 292,424.04

No change orders were issued. The final renewal period ended on June 30, 2019. All of the requirements of the contract have been met by Total Insulation Mechanical, Inc., and the Director of Electric Services has provided a certificate of completion.

ALTERNATIVES:

1. Accept completion of the contract under Invitation to Bid No. 2015-108 for Non-Asbestos Insulation and Related Services for Power Plant FY2014/15 through FY 2018/19 with Total Insulation Mechanical, Inc., Story City, Iowa, in the total amount of \$182,575.96.
2. Delay acceptance of this contract.

MANAGER'S RECOMMENDED ACTION:

Total Insulation Mechanical, Inc., the contractor for the Non-Asbestos Insulation and Related Services for Power Plant for FY 2014/15 through FY 2018/19, has completed all work required under the contract. The Director of Electric Services has issued a certificate of completion for the work.

Therefore, it is the recommendation of the City Manager that the City Council adopt Alternative No. 1 as stated above.

RESOLUTION NO. 19-_____

**RESOLUTION IN SUPPORT OF
THE HEALTHY LIFE CENTER BOND REFERENDUM VOTE
FOR THE CITY OF AMES, IOWA**

WHEREAS, the Ames City Council is committed to creating a one-of-a-kind Healthy Life Center that will help in making the life-long goal of healthy living accessible and enjoyable to people of all ages and socio-economic status in Ames and Story County; and,

WHEREAS, the Healthy Life Center represents an unprecedented partnership among the City of Ames, Mary Greeley Medical Center, Iowa State University, Heartland Senior Services, Story County, and Des Moines Area Community College; and,

WHEREAS, 41%, or \$20,000,000, out of the approximately \$49,000,000 needed to construct the project has been committed from private contributors and government entities; and,

WHEREAS, the Healthy Life Center is planned to house a participation kitchen, multi-purpose courts, café, indoor aquatics center (with therapeutic pool, water slides, lap pool, and zero-depth basin with a lazy river), cardio vascular equipment, walking track, meeting rooms, indoor/outdoor playgrounds, rehabilitation equipment, senior service facilities, and community garden; and,

WHEREAS, the City of Ames has been transparent regarding the development of the Healthy Life Center, holding numerous meetings since November 2016 to discuss the evolution of the concept, providing financial projections for the facility, and has given careful consideration to the risks associated with moving forward with the project; and,

WHEREAS, local government plays a primary role in providing quality-of-life amenities to a community that oftentimes require tax support for their operations, e.g., Ada Hayden Heritage Park, Furman Aquatic Center, Ames Public Library, and the City Hall Auditorium/Community Center; and,

WHEREAS, amenities that enhance the quality-of-life in a community benefit everyone, make a city vibrant, and help attract new jobs, families, and retirees to a community; this results in increased property and sales tax revenues, school populations, and more social capital; and,

WHEREAS, these quality-of-life amenities will serve to bolster the City's ability to provide exceptional public services to everyone who lives in and visits Ames.

NOW THEREFORE, BE IT RESOLVED that the Ames City Council is unanimous in its support of the Healthy Life Center and encourages our citizens to vote YES on September 10th!

ADOPTED THIS 27th day of August, 2019.

Diane R. Voss, City Clerk

John A. Haila, Mayor

Introduced by:

Seconded by:

Voting aye:

Voting nay:

Absent:

Resolution declared adopted and signed by the Mayor this 27th day of August, 2019.

OLD CAF
ITEM # 40
DATE: ~~08-13-19~~
08-27-19

COUNCIL ACTION FORM

SUBJECT: REQUEST TO APPROVE COLLABORATION WITH IOWA STATE UNIVERSITY'S PRINCIPLES OF COMMUNITY CAMPAIGN

BACKGROUND:

Almost 15 years ago, Iowa State University's campus was defaced with homophobic graffiti, an incident in a recurring series of chalking across campus targeting marginalized populations. These incidents spurred the grass roots, student-led and staff/faculty supported creation of the Principles of Community. Six values were identified as the foundation of expected community conduct. ISU community members serving on the Principles Commission and working through student government sought input and refined the document. In 2007, former ISU President Geoffrey approved the work of the Principles Commission including the six values that form the Principles of Community. He said at the time, "It is an affirmation of the kind of community we aspire to create at Iowa State."

The six values are:

- Richness of Diversity
- Freedom from Discrimination
- Respect
- Purpose
- Honest and Respectful Expression of Ideas
- Cooperation

For the last several years, the Iowa State University Office of Diversity and Inclusion has actively promoted the Principles of Community. The values are widely distributed around Iowa State. They are featured on posters in many campus buildings, on banners flanking campus sidewalks, incorporated into class syllabus and student welcomes, featured on the Iowa State University website, and explained in a Principles of Community video. **Having successfully promoted the Principles of Community on campus, the Office of Diversity and Inclusion is reaching out beyond ISU campus to the Ames community to help share the message of inclusivity, tolerance, and respect.** By incorporating the Principles of Community off campus, Iowa State students would experience a seamless transition from the university environment into the community.

The Ames City Council is being asked to embrace the Principles of Community campaign by introducing the values to community members through co-branded marketing materials. This would be one very visible and obvious way to support the City Council goal of “Promoting a Sense of One Community.”

By using our in-house graphics capabilities, the Public Relations Office could replicate the Principles of Community messaging and expand it beyond students to citizens. It is believed the town-and-gown partnership will be strengthened through the mutual support for the principles and their appearance not only on campus but through public buildings such as City Hall and the Ames Public Library.

As it was developed years ago, the Principles of Community focuses on the student experience. **With the urging of the Office of Diversity and Inclusion, the co-branded message would expand and represent all community members. Rather than affirming the “kind of community we aspire to create at Iowa State,” the revised Principles of Community would affirm the “kind of city we aspire to create in Ames.”**

Principles of Community (With modifications shown for a community campaign)

Respect: We seek to foster an open-minded understanding among individuals, organizations and groups. We support this understanding through outreach, increasing opportunities for collaboration, ~~formal education programs~~ and strategies for resolving disagreement.

Purpose: We are encouraged to be engaged in the ~~university~~ community. Thus, we strive to build a genuine community that promotes the advancement of knowledge, cooperation and leadership.

Cooperation: ~~We recognize that the mission of the university is enhanced when we work together to achieve the goals of the university. Therefore~~ We value each member of ~~the Iowa State University~~ our community for their insights and efforts, collective and individual, to enhance the quality of ~~campus~~ life.

Richness of Diversity: We recognize and cherish the richness of diversity in our community ~~university experience~~. Furthermore, we strive to increase the diversity of ideas, cultures and experiences throughout the ~~university~~ community.

Freedom from discrimination: We recognize that we must strive to overcome historical and divisive biases in our society. Therefore, we commit ourselves to create and maintain a community in which everyone ~~all students, staff, faculty and administrators~~ can work together in an atmosphere free from discrimination, and to respond appropriately to all acts of discrimination.

Honest and respectful expression of ideas: We affirm the right to and the importance of a free exchange of ideas at Iowa State University within the bounds of courtesy, sensitivity and respect. We work together to promote awareness of various ideas through education and constructive strategies to consider and engage in honest disagreements.

Examples of the Iowa State University Principles of Community and what the Ames co-branded posters could look like are included in Example 1 and Example 2.

Principles of Community

RICHNESS OF DIVERSITY

No two people in Ames are the same—
and that's a good thing.

RESPECT FREEDOM FROM DISCRIMINATION COOPERATION PURPOSE EXPRESSION OF IDEAS RICHNESS OF DIVERSITY



RESPECT FREEDOM FROM DISCRIMINATION COOPERATION PURPOSE EXPRESSION OF IDEAS RICHNESS OF DIVERSITY

We recognize and cherish the richness of diversity in our community experience. Furthermore, we strive to increase the diversity of ideas, cultures and experiences throughout the community.



IOWA STATE UNIVERSITY

RICHNESS OF DIVERSITY

No two people at Iowa State University are
the same—and that's a good thing.



We recognize and cherish the richness of diversity in our university
experience. Furthermore, we strive to increase the diversity of ideas,
cultures and experiences throughout the university community.

ALTERNATIVES:

1. Approve the request from Iowa State University to collaborate and co-brand the Principles of Community for inclusion in public buildings. Also, make the campaign available to private organizations who ask to participate.
2. Do not approve the collaboration with Iowa State University at this time.

MANAGER'S RECOMMENDED ACTION:

The City staff was first approached by the ISU Office of Diversity and Inclusion to collaborate on this initiative. While the “Principles of Community” campaign appears to be in support of the City Council’s goal of “Promoting a Sense of One Community”, the staff did not want to proceed with the co-branding without first obtaining approval from the City Council.

Staff believes that this collaboration is an effective and simple way to promote one of the Council’s goals and will not result in significant City expenditures or staff time. Therefore, it is the recommendation of the City Manager that the City Council adopt Alternative No. 1.

COUNCIL ACTION FORM

**SUBJECT: SALE AND ISSUANCE OF GENERAL OBLIGATION BONDS SERIES
2019A ISSUE IN AN AMOUNT NOT TO EXCEED \$11,880,000**

BACKGROUND:

The FY 2019/20 adopted budget includes General Obligation (G.O.) Bond-funded capital improvement projects in the amount of \$11,154,204. The City Council held a public hearing on the issuance of these bonds on March 5, 2019 as part of the budget process. Council action is now required to authorize the sale.

Projects to be funded by this bond issue include the following:

City-Wide Radio System	\$1,240,000	
Grand Avenue Extension	2,000,000	
Campustown Improvements	1,000,000	
Cherry Avenue Extension	300,000	
Arterial Street Pavement Improvements	1,600,000	
Bridge Rehabilitation	120,000	
Concrete Pavement Improvements	2,800,000	
Collector Street Pavement Improvements	500,000	
Asphalt Street Improvements	<u>1,000,000</u>	
Subtotal Tax Supported Bonds		\$ 10,560,000
City-Wide Radio System (Abated)	280,000	
ISU Research Park Phase IV (TIF)	<u>314,204</u>	
Subtotal Abated Bonds		<u>\$594,204</u>
Total Bond Funded Projects		\$11,154,204
Issuance Cost and Allowance for Premium		725,796
Grand Total – 2019/20 G.O. Issue		<u>\$ 11,880,000</u>

On the morning of August 27, 2019, the City will accept bids for the bonds per the terms of our offering statement. The bids will be evaluated by our financial advisor, Public Financial Management (the City’s Bond Counsel) and by City staff to recommend award to the bidder with the lowest cost. A report of bids will be provided to Council at the August 27, 2019 meeting. The City Council will then be asked to adopt a resolution accepting bids and authorizing award of the sale of bonds to the chosen bidder.

ALTERNATIVES:

1. The City Council can adopt a resolution accepting bids and authorizing the sale and issuance of General Obligation Bonds in an amount not to exceed \$11,880,000.
2. The Council can reject the bond sale resolution and delay the capital projects.

MANAGER'S RECOMMENDED ACTION:

Issuance of these bonds is necessary in order to accomplish the City's approved capital improvements during this fiscal year.

Therefore, it is the recommendation of the City Manager that the City Council accept Alternative No. 1, thereby adopting a resolution accepting bids and authorizing the sale and issuance of General Obligation Bonds in an amount not to exceed \$11,880,000.



MEMO

Item No. 42

To: Mayor Haila and Members of the Ames City Council
From: Sara Van Meeteren, Building Official
Date: August 16, 2019
Subject: Rental Code Changes

The Ames City Council made the following motions at the July 23, 2019 Council Meeting:

Directed staff to include making illegal rentals ineligible for LOCs for one year. (Amendment to Sec. 13.301(1) shown in italics on attachment).

Directed staff to include the ability to issue an order for Rent Abatement in toolbox. (New Sec. 13.104(2)(f))

Directed staff to freeze bedrooms in Near Campus Neighborhoods. (Removed the strikethrough text in Sec.13.503(4)(e)(iii))

Staff presented draft ordinances for these motions to Council on August 13, 2019. Council made a motion to change the language for the unregistered rental ordinance so that it gave staff the ability to prohibit a property from being registered for one year instead of strictly forbidding the property from being registered. This update is reflected in the attached draft.

The Ames Rental Association, Central Iowa Board of Realtors, Student Government, rental permit holders, and neighborhood association representatives have all been notified of the proposed changes.

ORDINANCE NO.

AN ORDINANCE TO AMEND THE MUNICIPAL CODE OF THE CITY OF AMES, IOWA, BY ENACTING A NEW SECTION THEREOF, FOR THE PURPOSE OF RENTAL CODE CHANGES CHAPTER 13 REPEALING ANY AND ALL ORDINANCES OR PARTS OF ORDINANCES IN CONFLICT TO THE EXTENT OF SUCH CONFLICT; PROVIDING A PENALTY; AND ESTABLISHING AN EFFECTIVE DATE.

BE IT ENACTED, by the City Council for the City of Ames, Iowa, that:

Section One. The Municipal Code of the City of Ames, Iowa shall be and the same is hereby amended by enacting a new Section as follows:

“Sec. 13.104. VIOLATIONS AND ENFORCEMENT.

(2) Enforcement.

...

(f) Rent Abatement.

i.) The Building Official may order rent abated when the Building Official determines that the owner has, after issuance of a notice of violation of this chapter:

a.) Failed to provide an essential service (water, sewer, electricity, heat);

b.) Failed to remedy a condition that poses a substantial risk to the health or safety of the tenant;

c.) Rented a dwelling unit without a valid Letter of Compliance; or,

d.) Failed to make corrections as required in the inspection report.

(ii) Rent abatement means that the owner may not recover rent from the tenant.

Rent shall be abated until the condition for which rent abatement was ordered has, in the judgment of the Building Official, been remedied.

(iii) The Building Official shall provide a copy of the rent abatement order to the owner at the address on the rental permit and to the tenant by U.S. mail and by posting the entrance door to the dwelling unit. Notice of termination of the rent abatement will be given in the same manner.

Sec. 13.301. LETTER OF COMPLIANCE (LOC)

(1) Letter of Compliance required.

No owner or operator shall rent, or offer for rent, any dwelling unit for use in whole or in part for human habitation, unless:

(a) it is registered as a rental dwelling with the Inspection Division, and

(b) a valid Letter of Compliance has been issued, or is pending, subject to inspection approval.

Properties determined to have been rented without a valid Letter of Compliance may be ineligible for a Letter of Compliance for a period of one year beginning on the date in which City staff determined the property was being illegally rented. The property cannot be leased during this year.

...

Sec. 13.503. OCCUPANCY LIMITATIONS

...
(4)

...

(e)

...

(iii) For ~~rental~~ dwelling units located within the Near Campus Neighborhoods ~~and that are registered as of January 1, 2018,~~ the number of bedrooms for determining maximum occupancy shall be determined by the number of bedrooms listed in the records of the Ames City Assessor as of January 1, 2018, or by the number of bedrooms reflected in the inspection records of the City of Ames Inspection Division as of January 1, 2018, whichever number is higher.

13.503

(4)

(e)

~~(iv) For rental dwellings located within the Near Campus Neighborhoods for which a registration is being sought after January 1, 2018, the number of bedrooms for determining maximum occupancy shall be determined by an inspection of the Inspection Division.”~~

Section Two. Violation of the provisions of this ordinance shall constitute a municipal infraction punishable as set out by law.

Section Three. All ordinances, or parts of ordinances, in conflict herewith are hereby repealed to the extent of such conflict, if any.

Section Four. This ordinance shall be in full force and effect from and after its passage and publication as required by law.

Passed this _____ day of _____, _____.

Diane R. Voss, City Clerk

John A. Haila, Mayor

Staff Report

CARBON MONOXIDE ALARMS

August 27, 2019

BACKGROUND:

During Council's discussion of the guest lodging ordinance at the Council Meeting on July 23, 2019, a motion was approved to *'include a carbon monoxide detector requirement proposal from staff'* the next time the ordinance was discussed. This staff report explains the existing carbon monoxide alarm requirements and the steps that would be needed if Council decided to add requirements to the guest lodging ordinance.

CURRENT CODE:

The Rental Code does not require carbon monoxide alarms in rental dwellings unless the property has more than one unit and the units share a common furnace.

The Building and Fire Codes both require carbon monoxide alarms in all new construction. However, since these are construction codes and not maintenance codes, they do not apply to existing buildings unless triggered by an addition or alteration.

In 2016, the State Legislature amended the smoke detector statute to require carbon monoxide alarms in all residential buildings that contain fuel-burning appliances or an attached garage. These amendments went into effect on July 1, 2018; pursuant to the amended statute, in February 2018, the State Fire Marshal adopted regulations addressing carbon monoxide alarms that also went into effect on July 1, 2018. Buildings affected by the amendments and regulations include both rental and owner-occupied dwellings. Every residential dwelling is required to be in compliance with these standards even though the City has not adopted an ordinance. Violations of the statute and regulations would be subject to the penalties set out by the State of Iowa.

MOVING FORWARD:

The City Council has the ability to adopt the State's language on carbon monoxide alarms and implement an enforcement program. Should Council decide to pursue requirements for carbon monoxide alarms they will need to determine which properties they want the regulations applied to at the local level (all properties are subject to them at the State level). The different options include:

- 1.) Adopting carbon monoxide alarm requirements for guest lodging only; or
- 2.) Adopting carbon monoxide alarm requirements for guest lodging and all registered rental properties; or

3.) Adopting carbon monoxide alarm requirements for all residential dwellings.

Option 1 would require carbon monoxide alarms in dwellings used for guest lodging. Guest lodging dwellings not in compliance with the local standards would be subject to a Municipal Infraction Citation or revocation of their guest lodging permit. They would also be subject to any State enforcement if they are reported to the State. Registered rentals without a guest lodging permit would not be subject to the carbon monoxide alarm requirements. This option would require language to be added to the guest lodging ordinance/checklist.

If Council wants to move forward quickly with the guest lodging ordinance and wants to include a carbon monoxide detector requirement, it would be best to choose Option 1 and reference the State Code. The process for this amendment would be much quicker than an amendment to the Rental Code.

Option 2 would require carbon monoxide alarms in all registered rentals and all dwellings used as guest lodging. **This option will take more time because it would be an amendment to the Rental Code and would require staff to provide outreach to the rental community, draft the ordinance, and go through three readings.** The guest lodging ordinance already references the code section that the ordinance would be added to so there would be no need to change the guest lodging ordinance

Option 3 is the equivalent of the State ordinance. It would require each owner-occupied dwelling and all registered rentals to install carbon monoxide alarms. Enforcement on owner-occupied dwellings would likely be conducted on a complaint basis or in addition to other building/trade inspections. Again, this is already in place at the State level, but is not being enforced locally since it hasn't been adopted into the Municipal Code. Enforcement of this option would be nearly impossible to enforce given the number of dwellings.

STAFF COMMENTS:

Staff is supportive of Option 2 because it provides for an extra level of safety for all registered rental units. Since the adoption of this second option would lead to the incorporation of the new requirement into the existing rental inspection process, there would be no additional processes or procedures needed.

COUNCIL ACTION FORM

SUBJECT: FLEET SERVICES – CARBON EMISSIONS REDUCTION – B100 PILOT PROGRAM

BACKGROUND:

In February of 2019, Ames based Renewable Energy Group (REG), and Optimus Technologies of Pittsburgh, PA presented their proposal for a 100% Biodiesel (B100) Pilot Program to representatives from the City of Ames, Iowa DOT, and other Iowa municipalities.

As presented, the B100 Pilot Program would require participant cities/agencies to provide 5 diesel powered trucks as pilot vehicles to operate year-round on B100 fuel, thereby taking full advantage of the B100 low carbon emissions. REG would be the exclusive supplier of B100 at a discounted rate to the City, and pay to fully equip the pilot trucks making it possible to use B100 year-round.

In support of the Ames City Council's initiative to promote city-wide environmentally sustainable projects, Fleet Services and the Public Works Street Division staff researched the proposal and found it to be feasible and beneficial to the City. Currently the City's diesel trucks burn 20% biodiesel blended with 80% ultra-low sulfur diesel (#2) (B20) during the warm months and a 3% bio-blend (B3) in the winter.

ABOUT THE COMPANIES:

Renewable Energy Group is the largest producer and marketer of biomass based fuel, with their Global Corporate Headquarters located in Ames. REG operates 10 bio-refineries in the United States, with expected 2019 production greater than 500 million gallons. In first quarter of 2019 REG sold 117 million gallons of biofuel resulting in a carbon reduction estimated at 900 thousand metric tons.

Optimus Technologies is the market leader in high performance biodiesel conversion solutions that utilize biodiesel (B100) and diesel for medium- and heavy-duty truck fleets. With Optimus, fleet operators have the simplest way to significantly reduce fuel costs and emissions, while addressing renewable fuel targets.

ABOUT B100 FUEL:

Biodiesel is made from feedstocks that are renewable resources such as animal fats, vegetable oils and recycled cooking oil. Refined biodiesel burns significantly cleaner

than standard diesel fuel (#2). **Looking at the full cycle of the fuel; from raw materials - to burning the finished product, there is an 85% reduction of harmful emissions when B100 is used instead of #2.**

B100 has equivalent fuel economy to #2 having the same miles per gallon. The lubricating characteristics (lubricity) of B100 is greater than #2, thereby adding protection against cylinder wear.

THE B100 PILOT PROGRAM:

The B100 Pilot Program will test and evaluate the use of B100 as a year-round fuel supply for 5 select City trucks equipped with the Optimus fuel management system for the purpose of reducing vehicle carbon emissions.

Fleet and Public Works staff have selected 5 heavy duty snow plow dump trucks to be equipped with the Optimus System for the pilot program. Provided the City agrees to have REG as the exclusive B100 supplier for the pilot program, REG agrees to pay for the 5 Optimus systems at \$12,000 each including installation. In addition, REG agrees to lease to the City of Ames a 12,000 gallon, above ground fuel dispensary for \$1 per year. City staff proposes the fuel dispensary location to be on the City's Maintenance Facility grounds located at 2207 Edison Street.

Optimus Technologies has developed a unique system to effectively use B100 year-round, even in cold temperatures. The Optimus system uses two fuel tanks, a smaller tank with #2 diesel, and a larger tank with B100. Optimus sends #2 diesel fuel to the engine at startup, then directs the heat from the engine to warm the B100 tank to a specified operating temperature, then switches to B100 for the majority of running time, even in cold temperatures. When the operator shuts off the engine Optimus will run the engine for about 30 seconds to purge the B100 from the engine's fuel lines – replacing it with petroleum diesel in preparation for the next cold engine start.

The Optimus system is backed with more than 10 years of research and development. In recent years the Optimus system has been successfully implemented in fleets in Chicago and Washington DC. The results from these fleets have been favorable with year-round B100 success even at cold temperatures.

BENEFITS OF THE PILOT PROGRAM:

- Places the City of Ames in a leadership position as the first government entity in the State of Iowa to implement this sustainable technology.
- Supports the City Council's goal to expand sustainability efforts.
- Provides accurate information about engine starts, idle time, vehicle location, miles, and fuel consumption.

- Guarantees a price for B100 slightly below the price per gallon offered by the Iowa DOT (the City's current provider).
- Identifies ways to reduce idle time.
- Improves vehicle performance with lower carbon exhaust output and greater lubrication to the engines.
- Does not prohibit the pilot trucks from operating solely on #2 diesel. The current engine and fuel systems stay intact, even with the Optimus system installed.
- Supports Iowa and local economies by the use of fuel produced in Iowa.

RISKS ASSOCIATED WITH THE PROJECT:

- The project could fail to meet the City's minimum expectations of performance.
- Regulatory changes could affect the availability and cost of B100 supplies affecting one or more of the project stakeholders.

IMPORTANT INFORMATION RELATED TO THE PILOT PROGRAM:

- Diesel consumption by City vehicles in FY 2019 including blended fuel (i.e. #2 diesel, B20, and B3) was 105,388 gallons
- The five pilot program vehicles burned 11,070 gal. of fuel in FY 2018-19
- B100 and #2 diesel have approximately the same fuel economy.
- **B100 has lifecycle carbon output 85% less than #2 diesel.**

CONTRACT DURATION:

The City staff agree the B100 Pilot Program supports the Ames City Council's initiative to promote city-wide environmentally sustainable projects, and demonstrate leadership in being a sustainable community.

REG and Optimus have presented the attached contract agreements to the City of Ames to participate in the proposed B100 Pilot Program. These contracts have been reviewed and determined acceptable by the City's Legal Department. The pilot program will continue for three (3) years beginning at the completion of the installation of the Optimus Systems onto the pilot trucks, or December 1, 2019, whichever is first.

ALTERNATIVES:

1. Approve the B100 Pilot Program participation
 - a. Approve the waiver of the Purchasing Policies and approve the attached contract with REG; 1) to be the exclusive provider to the City for 100% of the B100 required for the duration of the City's B100 Pilot Program, 2) to sell

- B100 to the City at the price five cents below the Des Moines area Gross Rack Average price per gallon for #2 Ultra Low Sulfur Diesel, 3) to lease one 12,000 gallon, above-ground B100 dispensary to the City for \$1 per year for the duration of the pilot program, and 4) pay to equip and install the Optimus system on 5 snow plow trucks.
- b. Approve the waiver of the Purchasing Policies and approve the attached contract with Optimus Technologies, Inc.; 1) to supply and install the Optimus system on selected City vehicles, 2) train City Fleet technicians to install and work on the system, and 3) collect real-time data about the fuel use, system performance, and location of the pilot program vehicles.
2. Instruct City staff to conduct further research into the B100 Pilot Program and report back to Council with additional information and recommendations.
 3. Reject the opportunity to participate in the pilot program.

MANAGER'S RECOMMENDED ACTION:

The participation in this pilot program will positively impact the City Council's goal of expanding the City's sustainability efforts. Therefore, it is the recommendation of the City Manager that the City Council adopt Alternative #1 as described above.



BIODIESEL FUEL SUPPLY AND TANK LEASE AGREEMENT

This Biodiesel Fuel Supply and Tank Lease Agreement (“Agreement”) is made and entered into as of _____, 2019 (the “Effective Date”), by and between _____ (“Customer”) and REG Marketing & Logistics Group, LLC (“REG”). Customer and REG may each be referred to hereafter individually as a “Party”, and collectively as the “Parties”.

WHEREAS, Customer has entered into an agreement with Optimus Technologies, Inc. (“Optimus”), to modify the fuel systems on certain vehicles to allow the vehicles to run on either diesel or biodiesel fuel (“Conversion Systems”);

WHEREAS, Customer desires to lease fuel tanks from REG, and purchase biodiesel fuel from REG; and

WHEREAS, REG desires to lease fuel tanks to Customer, and sell biodiesel fuel to Customer.

NOW, THEREFORE, in consideration of the mutual covenants and agreements stated below, the Parties agree as follows:

1. Biodiesel Fuel Supply. REG will be the exclusive provider of B99 biodiesel fuel (the “Product”) to Customer under the terms and conditions of **Schedule A** (the “Sales Contract”).

2. Funding for Vehicle Conversions. In consideration for Customer entering into this exclusive arrangement with REG for the purchase of biodiesel fuel, REG agrees to pay Optimus _____ dollars (\$ _____) on behalf of Customer to fund the purchase of _____ (____) Conversion Systems for Customer from Optimus. Customer and Optimus have entered into a separate agreement for the Conversion Systems, and Customer acknowledges that REG is not a party to that agreement and, except for the payment obligation herein, has no obligations to Customer arising out of or related to that agreement. Customer further acknowledges that REG is paying Optimus on Customer’s behalf based on Customer’s promise to compensate REG under the terms of the Sales Contract, without set-off for any reason related to Optimus, even if the Customer is not satisfied with Optimus or its Conversion Systems.

3. Fuel Tank Lease. REG will lease fuel tanks to Customer under the terms and conditions of **Schedule B**.

4. Payment and Taxes. Each Schedule specifies the fees that Customer shall pay REG. Customer agrees to pay REG in U.S. dollars by bank ACH or wire transfer, without any adjustments, discounts, or setoffs, within seven (7) days of receipt of each invoice. Past due payments shall bear interest of one percent (1%) per month or the maximum rate authorized by law, whichever is less. In addition to all other rights and remedies, REG may suspend, cancel, or terminate this Agreement if Customer does not pay all amounts due to REG as required herein. Customer will be liable for, and will pay and/or reimburse REG for, the payment of any and all taxes, fees, duties, assessments, and other charges (“Tax”), whether now existing or hereafter arising, which are imposed, levied, or assessed by any federal, state, tribal, or local governmental or regulatory authority with respect to any products sold and delivered to Customer, the taxable incident of which arises out of or relates to the sale, delivery, receipt, or transfer of title of products to Customer, or its inspection, removal from storage, measurement, receipt of payment, or other activity, regardless of when imposed. Customer agrees to promptly reimburse REG

in the event REG is required to pay any such Tax directly to the appropriate authority. Customer will furnish REG with any exemption or resale certificate or direct payment permit to which Customer may be entitled and promptly notify REG of any change in the validity or scope of same. Customer shall not be responsible for any taxes based on REG's income, corporate franchise tax, or license fee.

5. Term and Termination. This Agreement shall commence on the Effective Date and shall continue in full force and effect until [REDACTED], or until terminated by either Party pursuant to the termination rights set forth herein. Either Party may terminate this Agreement and/or an applicable Schedule due to a material breach of this Agreement and/or such applicable Schedule by the other Party if such material breach remains uncured for a period of thirty (30) days following receipt by the breaching Party of written notice given by the non-breaching Party specifying the breach; provided, that, if such breach is not reasonably capable of cure within such thirty (30)-day period the non-breaching Party may terminate this Agreement immediately upon notice to the breaching Party. Unless otherwise expressly provided in a Schedule, upon termination of this Agreement and/or any Schedule, Customer shall compensate REG pursuant to the terms of this Agreement and the applicable Schedule for products provided prior to the effective date of such termination. The provisions of this Agreement that, by their terms, are to survive the termination or expiration of this Agreement shall survive the termination or expiration of this Agreement. Without limiting the generality of the foregoing, Sections 5 through 10 shall survive the termination or expiration of this Agreement. Such expiration or termination shall also not affect any liability or obligation that accrues prior to such expiration or termination, including, without limitation, any liability for loss or damage on account of breach hereof by either Party.

6. Confidential Information. For purposes of this Agreement, “**Confidential Information**” shall mean all information, data, or other materials disclosed or made available by or on behalf of the disclosing Party to the receiving Party, regardless of the manner, medium, or form in which it is communicated or maintained, and regardless of whether the same is owned by the disclosing Party or a third party. Confidential Information shall not include information that: (i) can be clearly demonstrated to be generally known or available to the public prior to the Effective Date, or becomes so after the Effective Date through no act or omission on the part of the receiving Party; (ii) was in the possession of or rightfully known by the receiving Party on a non-confidential basis prior to its disclosure under this Agreement, or becomes available to the receiving Party on a non-confidential basis from a source other than the disclosing Party, as evidenced by the receiving Party's written records, provided that the source of such information was not bound by a confidentiality agreement or other contractual, legal, or fiduciary obligation of confidentiality to any person with respect to such material; or (iii) is independently developed by the receiving Party without reference to any Confidential Information of the disclosing Party and without the participation of any receiving Party personnel who or which have had access to the disclosing Party's Confidential Information, in each case as evidenced by the receiving Party's written records. The receiving Party acknowledges and agrees any and all Confidential Information that it receives from the disclosing Party is confidential in nature, constitutes a valuable asset of the disclosing Party, and is properly the subject of protection. As a result, the receiving Party agrees as follows: (i) the receiving Party shall use the disclosing Party's Confidential Information only for the specific purpose for which it was provided in furtherance of the relationship between the Parties, except to the extent otherwise authorized in writing by the disclosing Party; (ii) as between the Parties, the disclosing Party's Confidential Information shall at all times be owned solely and exclusively by the disclosing Party and the receiving Party shall not have any right, title, or interest in or to any of the disclosing Party's Confidential Information; (iii) the receiving Party shall not disclose or communicate the disclosing Party's Confidential Information to any third party, except to the extent the disclosing Party has provided its prior written consent to such disclosure and such third party has agreed in writing to be bound by the terms of this Agreement; (iv) the receiving Party shall grant access to the disclosing Party's Confidential Information only to its personnel that have a need to know such Confidential Information for the purposes permitted under this Agreement, and only after such person has agreed in writing to be bound by the

terms of this Agreement or is otherwise subject to an existing obligation of confidentiality and non-disclosure with respect to such Confidential Information that is no less stringent than the obligations set forth herein, and the receiving Party shall be liable hereunder for any failure of its personnel to abide by the terms of this Agreement; (v) the receiving Party shall protect the disclosing Party's Confidential Information with the same degree of care as it uses to protect its own confidential information, but in no event shall the receiving Party use less than a commercially reasonable degree of care to protect the security of such Confidential Information; (vi) upon learning of any unauthorized disclosure or use of the disclosing Party's Confidential Information, the receiving Party shall promptly notify the disclosing Party of such unauthorized disclosure or use and fully cooperate with the disclosing Party to protect such Confidential Information; and (vii) the receiving Party shall comply with all applicable local, state, and federal laws, regulations, ordinances, and orders related to the permissible use of the disclosing Party's Confidential Information. Upon the written request of the disclosing Party, the receiving Party shall promptly return to the disclosing Party or destroy all or any part of the disclosing Party's Confidential Information. Upon such return or destruction, the receiving Party shall deliver to the disclosing Party a certificate signed by an authorized representative of the receiving Party, in a form satisfactory to the disclosing Party, certifying that the disclosing Party's Confidential Information specified in the request has been returned or destroyed. Notwithstanding the foregoing, the receiving Party shall be permitted to (i) retain the disclosing Party's Confidential Information in archival storage in accordance with its internal data retention policies (but only to the extent such retention is otherwise permitted by applicable law), and (ii) retain copies of the disclosing Party's Confidential Information to the extent necessary to comply with applicable legal and regulatory requirements.

7. Indemnification.

(a) Customer agrees to defend, indemnify, and hold REG, including its affiliates, and all of their respective officers, directors, agents, and employees (each, an "**REG Indemnitee**"), harmless from and against any and all claims, demands, liabilities, losses, damages, actions, judgments, costs, expenses, fines, and reasonable attorneys' fees (collectively, "**Claims**") asserted by a third party against any REG Indemnitee to the extent arising out of, related to, or in connection with: (A) any breach of this Agreement (including any Schedule) by Customer; (B) any damage to or loss or destruction of the Fuel Tank(s) while in the possession or under the control of Customer; (C) any fuel spills or leaks from the Fuel Tank(s), or other release of fuel into the environment, except to the extent caused by negligent acts or omissions of REG while refilling or servicing the Fuel Tank(s); (D) Customer's negligent acts, omissions, and/or willful misconduct; or (E) any violation by Customer of any federal, state, or local laws, regulations, ordinances, or orders.

(b) REG agrees to defend, indemnify, and hold Customer and all of its officers, directors, agents, and employees (each, a "**Customer Indemnitee**"), harmless from and against any and all Claims asserted by a third party against any Customer Indemnitee to the extent arising out of, related to, or in connection with: (A) any breach of this Agreement by REG; (B) REG's negligent acts, omissions, and/or willful misconduct; or (C) any violation by REG of any federal, state, or local laws, regulations, ordinances, or orders.

(c) Any Indemnitee seeking indemnification for a Claim made by a third party under this Section shall give prompt written notice to the indemnifying party of such Claim; provided, however, the failure by an Indemnitee to give such notice shall not relieve the indemnifying party of its obligations under this Section, except to the extent that the indemnifying party is materially prejudiced as a result of such failure. In addition, the Indemnitee shall allow the indemnifying party to direct the defense and settlement of any such Claim, with counsel of the indemnifying party's choosing, and shall provide the indemnifying party, at the indemnifying party's expense, with such information and assistance as is reasonably necessary for the defense and settlement of the Claim. The Indemnitee shall have the right to

employ separate counsel and to participate in (but not control) any such action, but the fees and expenses of such counsel shall be at the expense of the Indemnitee. The indemnifying party shall not consent to the entry of any judgment or enter into any settlement that does not include as an unconditional term thereof the giving by the claimant or plaintiff to the Indemnitee a release from all liability with respect to the Claim.

8. LIMITATION OF LIABILITY. NEITHER PARTY SHALL BE LIABLE TO THE OTHER FOR CONSEQUENTIAL, INCIDENTAL, OR PUNITIVE DAMAGES ARISING OUT OF ANY BREACH OF THIS AGREEMENT.

9. Notice. All notices required under this Agreement or any Schedule shall be in writing and shall be considered given: (a) when delivered personally; (b) three (3) days after mailing, when sent certified mail, return receipt requested and postage pre-paid; or (c) one (1) business day after dispatch, when sent via a commercial overnight courier, fees pre-paid. All notices to REG shall be sent to: Renewable Energy Group, Attn: Jon Scharingson, 416 South Bell Avenue, Ames, IA 50010; with a copy to Renewable Energy Group, Attn: Matt Giles, 416 South Bell Avenue, Ames, IA 50010. All notices to Customer shall be sent to: _____.

10. General Provisions.

(a) **Entire Agreement.** This Agreement sets forth the entire and exclusive understanding and statement of the relationship between the Parties and supersedes, and hereby renders null and void, all previous or contemporaneous oral or written proposals, negotiations, arrangements, understandings, agreements, guidelines, representations, warranties, terms, conditions, covenants, and any other communication between the Parties, including their respective officers, employees, agents, or affiliates, relating to the subject matter of this Agreement. In the event of a conflict between or among the provisions of this Agreement, a Schedule, or a Sales Contract, the terms of such documents shall control in this order of precedence: (i) Sales Contract, (ii) a Schedule, and (iii) this Agreement. Any pre-printed terms and conditions on any materials that either Party uses (e.g., purchase orders, order forms, invoices) are null and void and of no consequence whatsoever in interpreting the Parties' legal rights and responsibilities hereunder.

(b) **Assignment.** Notwithstanding any term or condition in this Agreement that may appear to be to the contrary, neither this Agreement, nor any rights or obligations of either Party, may be assigned, delegated, or subcontracted unless such assignment, delegation, or subcontract is in writing and consented to in writing by the other Party. Any attempt by either Party to assign, delegate, or subcontract this Agreement other than as permitted herein shall be null and void.

(c) **Amendments.** No amendment, change, or modification of any of the terms, provisions, or conditions of this Agreement shall be effective unless such amendment is clearly identified as an amendment to this Agreement, made in writing, and signed by authorized personnel of both Parties.

(d) **Waiver.** No failure or delay on the part of either Party in exercising any right, power, or remedy hereunder shall operate as a waiver thereof, nor shall any single or partial exercise of any such right, power, or remedy preclude any other or further exercise thereof or the exercise of any other right, power, or remedy. No waiver of any breach of this Agreement shall be effective unless in writing and signed by an authorized representative of the non-breaching Party. Any waiver of any provision of this Agreement, and any consent to any departure from the terms of any provision of this Agreement, shall be effective only in the specific instance and for the specific purpose for which made or given.

(e) **Severability.** In the event any provision of this Agreement is held invalid, illegal, or unenforceable, in whole or in part, the remaining provisions of this Agreement shall not be affected thereby and shall continue to be valid and enforceable. In the event any provision of this Agreement is held to be unenforceable as written, but enforceable if modified, then such provision shall be deemed to be amended to such extent as shall be necessary for such provision to be enforceable and it shall be enforced to that extent.

(f) **Parties in Interest.** This Agreement shall be binding upon and shall inure to the benefit of the Parties and their respective legal representatives, heirs, and permitted successors and assigns. Nothing in this Agreement, express or implied, is intended to confer, or shall confer, upon any person, other than the Parties (and their respective legal representatives, heirs, and permitted successors and assigns), any rights, remedies, obligations, or liabilities under or by reason of this Agreement; provided, however, that the persons indemnified hereunder shall have the right to enforce the indemnification provisions of this Agreement.

(g) **Remedies not Exclusive; Specific Performance.** Unless otherwise expressly stated herein, the rights and remedies of each Party under this Agreement are cumulative and not exclusive of any rights or remedies to which a Party is entitled at law, in equity, or otherwise. The exercise by either Party of any right or remedy under this Agreement or under applicable law shall not preclude such Party from exercising any other right or remedy under this Agreement or to which it is entitled by law, in equity, or otherwise.

(h) **Change in the Law.** Should any federal, state, or local statute, regulation, ordinance, incentive, or tax credit change in a manner that materially advantages or disadvantages a Party (in each Party's sole judgment), the Parties agree to, in good faith, renegotiate this Agreement to account for such change. Should that renegotiation be unsuccessful, then the disadvantaged Party may, at its sole discretion, unilaterally terminate this Agreement and all of each Parties' rights, duties, and obligations under this Agreement shall terminate and be of no further force and effect thirty (30) days after such Party provides written notice to the other Party that it does not believe in good faith that efforts to renegotiate the Agreement will be successful.

(i) **Force Majeure.** Neither Party shall be liable to the other for any delay or failure in performance hereunder to the extent that it is caused by circumstances beyond its reasonable control, including fire, explosion, plant or equipment failure, flood, earthquake, storm, act of God, sabotage or vandalism, strike or other labor disturbance, interruption of utility services, or compliance with any law, regulation, or order of any governmental or military authority ("Force Majeure Event"), provided that the Party invoking the Force Majeure Event agrees to (i) give prompt written notice of the Force Majeure Event; (ii) take all steps reasonably necessary to mitigate the effects of the Force Majeure Event; and (iii) if a Force Majeure Event extends for a period in excess of sixty (60) days in the aggregate, either Party may immediately terminate this Agreement upon written notice.

(j) **Construction.** This Agreement shall not be construed more strongly against either Party regardless of which Party was more responsible for its preparation.

(k) **Counterparts.** This Agreement may be executed in counterparts, each of which shall constitute an original, and all of which together shall constitute one and the same instrument. Any signatures to this Agreement transmitted by facsimile or electronic means shall have the same force and effect as original signatures.

(l) **Governing Law.** This Agreement shall be governed by and construed in accordance with the substantive laws of the state of Iowa, without giving effect to any conflict of law principles that may require the application of the laws of another jurisdiction.

(m) **Consent to Jurisdiction.** Each of the Parties hereby irrevocably submits to the exclusive jurisdiction of any United States District Court or Iowa District Court in any action or proceeding arising out of or relating to this Agreement, and each Party hereby irrevocably agrees that all claims in respect of such action or proceeding shall be heard and determined in either of such courts. Each of the Parties irrevocably waives any objection, including, without limitation, any objection on the grounds of forum nonconveniens, which it may now or hereafter have to the bringing of any such action or proceedings in such respective jurisdictions. In addition, the Parties agree that neither of them shall commence any action arising out of or relating to this Agreement in any court other than the United States District Court or the Iowa District Court.

(n) **WAIVER OF JURY TRIAL. EACH OF THE PARTIES HERETO IRREVOCABLY WAIVES ALL RIGHT TO TRIAL BY JURY IN ANY ACTION, PROCEEDING, OR COUNTERCLAIM (WHETHER BASED ON CONTRACT, TORT, OR OTHERWISE) ARISING OUT OF OR RELATING TO THIS AGREEMENT OR THE ACTIONS OF THE PARTIES IN THE PERFORMANCE OR ENFORCEMENT HEREOF.**

IN WITNESS WHEREOF, the authorized representatives of the Parties have executed this Agreement effective as of the Effective Date.

[Customer]

REG Marketing & Logistics Group, LLC

By: _____
Name: _____
Title: _____

By: _____
Name: _____
Title: _____

Schedule A

SALES CONTRACT

This Sales Contract (“Sales Contract”) is made and entered into as of [REDACTED], 2019 (the “Effective Date”), by and between [REDACTED] (“Customer”) and REG Marketing & Logistics Group, LLC (“REG”). Customer and REG may each be referred to hereafter individually as a “Party”, and collectively as the “Parties”.

WHEREAS, subject to the terms and conditions of this Sales Contract, Customer desires to exclusively purchase B99 biodiesel fuel manufactured by REG (the “Product”) and REG desires to be the exclusive provider of the Product to Customer; and

NOW, THEREFORE, in consideration of the mutual covenants and agreements stated below, the Parties agree as follows:

1. Exclusive Purchase and Sale of Product; Price. Subject to the terms and conditions of this Sales Contract, during the Term, Customer shall purchase exclusively from REG, and REG shall sell to Customer, one hundred percent (100%) of Customer’s requirements for the Product at a purchase price that is five (5) cents per gallon less than the Des Moines area Gross Rack Average price per gallon for #2 Ultra Low Sulfur Diesel (ULSD), as published by the Iowa Department of Transportation. This Sales Contract does not limit REG’s right to manufacture or sell, or preclude REG from manufacturing or selling, to any person or entity, or entering into any agreement with any other person or entity related to the manufacture or sale of, the Product and other goods or products that are similar to or competitive with the Product.

Formatted: Highlight

2. Ordering Procedure. From time-to-time during the Term, Customer shall issue to REG purchase orders for the purchase and delivery of the Product. By issuing a purchase order, Customer makes an offer to purchase the Product pursuant to the terms and conditions of this Sales Contract, and on no other terms. For the avoidance of doubt, any variations made to the terms and conditions of this Sales Contract by Customer in a purchase order are void and have no effect. REG accepts a purchase order by confirming the order in writing or by delivery the Product to Customer, whichever occurs first. REG may reject a purchase order or cancel a previously accepted purchase order, which it may do without liability or penalty if: (a) Customer has failed to pay any amount when due under this Sales Contract or under any previous purchase order; (b) Customer has breached any of its duties or obligations under this Sales Contract and such breach remains uncured at the time such purchase order was made or after such purchase order was made but where the Product to be sold under such purchase order has not been delivered to Customer; or (c) REG reasonably believes that Customer is in breach of any of its duties or obligations under this Sales Contract at the time such purchase order was made or after such purchase order was made but where the Product to be sold under such purchase order has not been delivered to Customer. From time-to-time, Customer shall, upon the request of REG, provide REG with an estimated forecast of Customer’s requirements for the Product for the time period stated in REG’s request, which forecast shall approximate, as nearly as possible based on information available at the time to Customer, the quantity of the Product that Customer may order for such period. Forecasts are for informational purposes only and do not create any binding obligations on behalf of either Party; provided, however, that REG shall not be required to sell or deliver to Customer any quantity of Product that is unreasonably disproportionate to any forecast for the period covered by such forecast.

3. Delivery Terms. All Product shall be delivered to Customer at the address listed in the purchase order (the “FOB Point”). Unless otherwise expressly agreed by the Parties in writing, REG shall select the method of shipment of and the carrier for the Product. REG may, in its sole discretion, without

liability or penalty, make partial shipments of Product to Customer. Each shipment will constitute a separate sale to Customer and Customer shall pay for the Product shipped, whether such shipment is in whole or partial fulfillment of a purchase order. Any time quoted for delivery is an estimate only; provided, however, that REG shall use commercially reasonable efforts to deliver all Product on or before the delivery date requested in a purchase order. Customer, its agents, or subcontractors shall coordinate with REG in advance on a schedule for Product delivery or other suitable arrangement. Title and risk of loss shall pass to Customer as Product transfers from the exit flange of REG's freight truck to Customer's input flange at its receiving tank located at the FOB Point. REG shall retain title to any vapors or condensate recovered during delivery. Customer shall pay for or be charged back for all transport costs incurred by REG in delivering Product to the FOB Point. Customer will notify REG at least 24 hours in advance of any required delivery; Customer is responsible for additional costs associated with loads ordered within 24 hours of delivery. Customer will be allowed one (1) hour for truck unloading and will be charged \$75.00 per hour thereafter for truck detention. Customer is responsible for costs associated with unloading and incomplete unloading. If Customer does not take delivery of Product at the contracted-specified time, Customer agrees to pay a roll fee of \$0.05 per gallon (\$150.00 minimum) plus an additional \$0.05 per gallon for each 30 day period thereafter until Customer takes delivery. All charges will be billed monthly and include substantiating documentation.

4. Measurement. All volumes delivered shall be temperature-adjusted to 60°F via built-in temperature compensators or ASTM tables. Either Party may require that Product quantity be determined by a jointly selected, licensed petroleum inspector, whose findings shall be conclusive. Customary inspection costs shall be shared equally; additional services shall be paid by the requesting Party. "Gallon" means a U.S. gallon of 231 cubic inches. All measurements/tests shall be in accordance with the latest ASTM standards or guidelines. Objections to measurements, including claims for shortage, for quantities delivered by REG must be made to REG within thirty (30) calendar days of the delivery date.

5. Product Certification. Upon Customer's request, at invoicing, REG will make available to Customer: (i) a Certificate of Analysis for each B100/B99.9 load and (ii) a Product safety data sheet, which may be updated from time to time.

6. Warranties; Disclaimer. The following are the sole warranties made by REG with respect to the Product:

a. Warranty of Quality. All Product supplied to Customer under this Sales Contract shall comply with the current ASTM D6751 specification.

b. Warranty of Title. REG warrants that it has good title to any Product sold and delivered hereunder, free of all liens, charges, encumbrances, pledges or security interests.

EXCEPT AS EXPRESSLY SET FORTH IN THIS SECTION 7, REG MAKES NO AND HEREBY DISCLAIMS ALL OTHER EXPRESS AND IMPLIED REPRESENTATIONS AND WARRANTIES WITH RESPECT TO THE PRODUCT INCLUDING, WITHOUT LIMITATION, ANY IMPLIED WARRANTIES OF MERCHANTABILITY OR FITNESS FOR A PARTICULAR PURPOSE, AND IMPLIED WARRANTIES ARISING FROM A COURSE OF DEALING OR PAST PERFORMANCE, USAGE OR TRADE PRACTICE. OTHER THAN AS SET FORTH IN SECTION 7(A), REG MAKES NO REPRESENTATIONS AS TO THE QUALITY, SUITABILITY OR ADEQUACY OF THE PRODUCT. THE FORGOING DISCLAIMERS SHALL APPLY EVEN IF THE EXPRESS, LIMITED WARRANTY SET FORTH IN THIS SECTION 7 FAILS OF ITS ESSENTIAL PURPOSE.

7. Credits.

a. RINS. All Renewable Identification Numbers (“RINS”) generated as a result of REG’s production of Product shall remain the sole property of REG.

b. Tax Credits. REG shall have the right to claim and receive all federal and state tax credits available as a result of Product sales hereunder. In the event that the Biodiesel Mixture Excise Tax Credit (under 26 U.S. Code 6426) or any substantially equivalent federal tax incentive that may be enacted and claimed as the result of selling Product, including, without limitation a production tax credit (“BTC”), is enacted after the Effective Date, REG shall receive 100% of the BTC. REG shall be the blender of record (“Blender of Record”) on all sales hereunder. The forgoing shall apply even if the BTC is enacted retroactively. The Parties shall make all necessary reasonable efforts to ensure that the BTC is fully available to the Blender of Record, including, but not limited to, filing or causing to be filed all tax returns and related tax papers necessary to apply for and obtain the BTC.

c. Carbon Credits. All carbon credits as a result of Product sales hereunder shall remain REG’s property, including, but not limited to, Low Carbon Fuel Standard credits generated by REG in the State of California.

8. Customer Claims; Remedies. If Customer discovers that any Product tendered fails to comply with the warranties in Section 6 (the “Limited Warranties”), Customer agrees to provide REG prompt written notice and, upon request, a representative Product sample within five (5) days of such request. For any Product failing to meet the Limited Warranties, if Customer timely notifies REG (i) prior to Product delivery, Customer may reject same; or (ii) after Product delivery, as Customer’s exclusive remedy, REG will, within a reasonable period of time, at REG’s option and cost (including return/redelivery expense), remedy the defect in, replace, or refund the purchase price of the Product; provided that, in either case the Parties may negotiate a mutually agreed price adjustment or other resolution. If Customer fails to notify REG of a defect within fifteen (15) days of Product delivery, such delivery shall, for all purposes, be deemed to be free of any defects and operate as Customer’s waiver and release of REG of any liability in respect to such claim.

9. Compliance with Law. Each Party (on behalf of themselves, and their respective employees and agents) agrees to comply with all applicable laws, regulations, and standards for Product manufacture, storage, sale, transportation, and disposition. Any commodities, technology or software associated herewith must be exported from the U.S. in accordance with the Export Administration Regulations. Diversions contrary to U.S. law are prohibited. Customer agrees that Product purchased hereunder shall be used as a fuel per Internal Revenue Code (“IRC”) Section 40A(b)(1)(B) and shall not be separated per IRC Section 40A(d)(3)(A). Should REG be notified or otherwise become aware of its disqualification for potential receipt of the biodiesel mixture credit under IRC Section 6426 for all or any part of any sale to Customer, REG shall have the right thereafter to cancel all or any part of any such sales made under this Sales Contract. If such disqualification is as a result of Customer’s actions, Customer shall reimburse REG for the amount of any credit which REG fails to receive or has to pay back on any completed sales.

10. Change in Law. Should any federal, state or local statute, regulation, ordinance, incentive, or tax credit change in a manner that materially advantages or disadvantages a Party (in each Party’s sole judgment), the Parties agree to, in good faith, renegotiate this Sales Contract to account for such change. Should that renegotiation be unsuccessful, then the disadvantaged Party may, at its sole discretion, unilaterally terminate this Sales Contract and all of each Parties’ rights, duties and obligations under this Sales Contract shall terminate and be of no further force and effect thirty (30) days after such Party provides written notice to the other Party that it does not believe in good faith that efforts to renegotiate the Sales Contract will be successful.

Schedule B

FUEL TANK LEASE

This Fuel Tank Lease (the "Lease") is effective as of the Effective Date by and between REG and Customer. The Parties agree as follows:

1. Lease; Term. REG agrees to lease to Customer, and Customer agrees to lease from REG, the Fuel Tank(s) described more fully in the schedule attached hereto as **Schedule B-1** subject to the terms of this Lease. This Lease is a non-cancelable lease. Customer's obligation to make all payments and other amounts under the Lease is absolute and unconditional and is not subject to any abatement, counterclaim, defense, deferment, interruption, recoupment, reduction, or setoff for any reason whatsoever. Unless terminated earlier as set forth herein, the term of this Lease shall commence on the Effective Date and continue for one (1) year. This Lease shall automatically renew for additional terms of one (1) year, unless either party provides at least thirty (30) days' written notice to the other party of its intent not to renew the Lease. The initial term and any renewal terms, if applicable, are hereinafter referred to as the "**Lease Term.**"

2. Lease Payments. Customer shall pay to REG one dollar (\$1.00), in addition to other good and valuable consideration, including entering into a Sales Contract in exchange for REG leasing the Fuel Tank(s) to Customer.

3. Title; Delivery and Acceptance. The Fuel Tank(s) is and shall remain REG's sole and exclusive property and Customer shall have the right to peacefully possess and use the Fuel Tank(s) during the Lease Term provided Customer is not in breach of this Lease. REG shall install the Fuel Tanks at the location specified in Schedule B-1. Customer shall promptly inspect the Fuel Tank(s) upon delivery and promptly notify REG of any defects in the Fuel Tank(s). The Fuel Tank(s) will be irrevocably accepted by Customer upon: (a) at REG's request, the delivery to REG of a signed delivery and acceptance certificate acceptable to REG; or (b) ten (10) days after delivery of the Fuel Tank(s) to Customer if previously REG has not received written notice from Customer of Customer's non-acceptance.

4. UCC True Lease.

(a) The parties intend that the Lease, including Schedule B-1, constitutes a true lease under the Uniform Commercial Code Chapter 554, Code of Iowa (the "**UCC**"), and not an Article 9 Security Interest, and the filing of a UCC financing statement, UCC fixture filing, or other similar filing or recording shall not be evidence to the contrary. REG shall have title to the Fuel Tank(s) at all times. Customer acquires no ownership, title, property, right, equity, or interest in the Fuel Tank(s) other than its leasehold interest solely as Customer subject to all the terms and conditions of the Lease. REG and Customer agree that no Fuel Tank constitutes a fixture or real property and the filing of any UCC fixture filing shall not be evidence to the contrary. TO THE EXTENT PERMITTED UNDER APPLICABLE LAW, CUSTOMER WAIVES ANY AND ALL RIGHTS AND REMEDIES CONFERRED UPON A CUSTOMER BY ARTICLE 13 OF THE UCC, including, without limitation, Iowa Code § 554.13508 through § 554.13522. If REG feels it is necessary, Customer agrees to provide REG with waivers of interest or liens in each Fuel Tank from anyone claiming any interest in the real estate on which any Fuel Tank is located.

(b) Customer authorizes REG to file UCC financing statements, UCC fixture filings, and other similar filings and recordings with respect thereto. Customer agrees not to file any corrective or termination statements or partial releases with respect to any UCC financing statement, UCC fixture

filing, or other similar filings, or recordings filed by REG in connection with any Fuel Tank except (i) if REG fails to file a corrective or termination statement or release on request from Customer after the expiration or earlier termination of, or release from, any Lease pursuant to any applicable provision of the Lease or (ii) if not permitted by clause (i), with REG's consent.

5. Tax Lease.

(a) Unless otherwise provided in the Schedule, REG and Customer acknowledge and agree that they are entering into the Lease on the income tax assumption that (a) REG will be treated for all federal income tax purposes (and to the extent allowable, for state and local tax purposes) as the owner of all Fuel Tank(s) leased pursuant to the Lease, (b) for all federal income tax purposes (and to the extent allowable, for state and local tax purposes), this Lease will be treated as a "true lease" of the Fuel Tank(s), and (c) REG is entitled to all deductions, credits, and other tax benefits that are provided in the Internal Revenue Code of 1986, as amended, to an owner of property ("**Tax Benefits**"). Notwithstanding the foregoing, Customer and REG each acknowledge and represent to the other that (a) each has made its own independent and separate analysis of the tax treatment and characterization for tax purposes of any Tax Benefits under this Lease, and (b) neither is relying on any representation, analysis, or advice of the other as to any tax treatment or characterization for tax purposes of any Tax Benefits under this Lease.

(b) Customer shall not take or omit to take any action that results in the disqualification of the Fuel Tank(s) for, or recapture of, all or any portion of the Tax Benefits. Without limiting the foregoing, Customer agrees that Customer will not at any time file any federal, state, or local income tax return that is inconsistent with the assumptions set forth in Section 5(a). Customer will file such returns, execute such documents, and take such actions as may be reasonable and necessary to facilitate accomplishment of the intent hereof. Customer will maintain sufficient records to enable REG to determine and verify REG's federal and state income tax liability with respect to the transactions contemplated herein and to determine and verify REG's potential tax liability with respect to each other taxing jurisdiction. In addition, within thirty (30) days after notice, Customer shall provide such information as REG may reasonably request to enable REG to fulfill its tax return filing obligation, to respond to requests for information, to verify information in connection with any income tax audit, and to participate effectively in any tax contest.

(c) If, as a result of a breach of any representation, warranty, or covenant of Customer: (a) REG determines that it is not entitled to claim on its federal income tax return all or any portion of the Tax Benefits; (b) any Tax Benefit claimed on REG's federal income tax return is disallowed or adjusted by the Internal Revenue Service; or (c) any Tax Benefit is recomputed or recaptured, Customer shall promptly pay to REG the amount, as determined by REG, of REG's net after-tax rate of return on such Fuel Tank(s) that would have been in effect on the date of the breach, had REG been entitled to use all of the Tax Benefits for such Fuel Tank(s), minus REG's actual net after-tax rate of return with respect to such Fuel Tank(s). The indemnities and assumptions of liability provided herein and all of REG's rights and privileges herein will inure to the benefit of REG's successors and assigns and will continue in full force and effect notwithstanding the expiration or termination of this Lease.

6. Exclusion of Warranties. REG MAKES NO WARRANTY WHATSOEVER, EXPRESS OR IMPLIED, INCLUDING ANY (A) WARRANTY OF MERCHANTABILITY, (B) WARRANTY OF FITNESS FOR A PARTICULAR PURPOSE, (C) WARRANTY AGAINST INTERFERENCE, OR (D) WARRANTY AGAINST INFRINGEMENT OF ANY PATENT, COPYRIGHT, TRADEMARK, TRADE SECRET, OR OTHER PROPRIETARY RIGHTS OF A THIRD PARTY, WHETHER ARISING BY LAW, COURSE OF DEALING, COURSE OF PERFORMANCE, USAGE OF TRADE, OR OTHERWISE. CUSTOMER AGREES THAT REGARDLESS OF CAUSE, REG IS NOT RESPONSIBLE FOR AND CUSTOMER WILL NOT

ASSERT ANY CLAIM AGAINST REG FOR ANY LOSS, DAMAGE, OR INJURY CAUSED OR ALLEGED TO BE CAUSED DIRECTLY, INDIRECTLY, INCIDENTALLY, OR CONSEQUENTIALLY BY THE FUEL TANK(S), ANY INADEQUACY, DEFICIENCY, OR DEFECT OF OR RELATED TO THE FUEL TANK(S), OR BY ANY INCIDENT WHATSOEVER IN CONNECTION WITH THE FUEL TANK(S), ARISING IN STRICT LIABILITY, NEGLIGENCE, OR OTHERWISE, OR IN ANY WAY RELATED TO OR ARISING OUT OF THIS LEASE. REG MAKES NO WARRANTY AS TO THE TREATMENT OF THIS LEASE FOR TAX OR ACCOUNTING PURPOSES.

7. Fuel Sales Contracts. Customer will purchase transportation fuel from REG under the terms and conditions as set forth the Sales Contract. A breach of the Sales Contract shall constitute a material breach of this Lease and an Event of Default (as defined below).

8. Customer's Representations and Warranties. Customer represents and warrants to REG:

(a) Customer is duly organized, validly existing, and in good standing in the jurisdiction of its organization; has all requisite right, power, and authority to execute, deliver, and perform its obligations under this Lease; and is duly authorized or qualified to do business and is in good standing in the jurisdiction in which it is using the Fuel Tank(s).

(b) Customer has full corporate power and authority to enter into the Lease, to carry out its obligations hereunder and thereunder, and to consummate the transactions contemplated hereby. The execution and delivery by Customer of this Lease, the performance by Customer of its obligations hereunder, and the consummation by Customer of the transactions contemplated hereby have been duly authorized by all requisite action on the part of Customer. This Lease has been duly executed and delivered by Customer, and this Lease constitutes a legal, valid, and binding obligation of Customer enforceable against Customer in accordance with its terms.

(c) The execution, delivery, and performance by Customer under this Lease, and the consummation of the transactions contemplated hereby and thereby, do not and will not: (a) conflict with or result in a violation or breach of, or default under, any provision of the certificate of incorporation, by-laws, or other organizational documents of Customer; (b) conflict with or result in a violation or breach of any provision of any applicable law; (c) require the consent of, notice to, or other action or, conflict with, result in a violation or breach of any other Lease, or constitute an Event of Default; or (d) result in the creation or imposition of any liens, security interests, or encumbrances on any Fuel Tank(s).

(d) No consent, approval, permit, order, declaration, or filing with, or notice to, any governmental authority is required by or with respect to Customer in connection with the execution of this Lease and the consummation of the transactions contemplated hereby and thereby.

(e) There are no actions, suits, claims, investigations, or proceedings pending or, to Customer's knowledge, threatened against or by Customer: (a) relating to or affecting Customer or any of Customer's property; or (b) that challenge or seek to prevent, enjoin, or otherwise delay the transactions contemplated by the Lease. At any time during the Term, if Customer shall become aware of any such action, suit, claim, investigation, or proceeding, Customer shall notify REG within fifteen (15) days of becoming aware of such matter.

(f) All permits, licenses, franchises, approvals, authorizations, registrations, certificates, variances, and similar rights ("**Permits**") obtained, or required to be obtained, from a governmental authority required for Customer to lease and use the Fuel Tank(s) have been obtained by

Customer and at all times during the Lease Term shall be valid and in full force and effect. All fees and charges with respect to the Permits will be paid in full.

9. Customer's Use of Fuel Tank(s). Customer shall keep and maintain the Fuel Tank(s) in good repair, condition, and working order, ordinary wear and tear excepted, and shall be responsible for any fuel spills or leaks from the Fuel Tank(s), except to the extent caused by negligent acts or omissions of REG while refilling or servicing the Fuel Tank(s). Customer shall grant access to the location of the Fuel Tank(s) to allow REG and/or its designated representative to install, refill, and service the Fuel Tank(s). Customer may not sublease the Fuel Tank(s) without REG's prior written consent. Customer may not move any Fuel Tank(s) from the location where it was installed by REG without REG's prior written consent. The parties intend that the Fuel Tank(s) remains at all times personal property and not a fixture under applicable law, even if the Fuel Tank(s), or any part thereof, may be or becomes affixed or attached to real property or any improvements. Upon REG's written request, Customer shall obtain and provide to REG, from each real property landlord, mortgagee, or lienholder for the location where the Fuel Tank(s) is located, a waiver of any interest that it may have in the Fuel Tank(s) arising from its interest in the real property. Customer, at its own expense, shall: (a) maintain all Fuel Tank(s)-related records, logs, and other materials in a manner no less comprehensive or accurate than Customer's normal customary practices with respect to Customer's similar equipment and as required by applicable law; and (b) promptly furnish to REG such records as may be required to enable REG to file any ownership or other reports required to be filed by REG with any governmental authority. Customer shall permit REG and/or its representatives, on reasonable notice, to inspect the Fuel Tank(s) and related records during regular business hours, and in compliance with Customer's reasonable security procedures. Customer agrees to provide REG with a agreement from anyone claiming any interest in the real estate on which any Fuel Tank is located or installed, granting REG access to the real estate to install, remove, refill, service, or inspect the Fuel Tank(s). Unless Customer has elected to renew this Lease, Customer shall during the last two (2) months of the Term, on REG's written notice, cooperate with REG's efforts to sell or lease the Fuel Tank(s), including, without limitation, permitting prospective purchasers or customers to fully inspect the Fuel Tank(s) and any applicable records during reasonable hours and in compliance with Customer's reasonable security procedures.

10. Loss. Customer shall bear all risk of loss, damage, destruction, theft, and condemnation to or of the Fuel Tank(s) from any cause whatsoever, other than those arising as a direct and proximate result of the gross negligence or willful misconduct of REG or its representatives ("**Loss**") whether or not insured, until the Fuel Tank(s) has been returned to REG. Customer shall promptly notify REG in writing of any Loss. In the event of any Loss, at REG's option, Customer shall either (i) repair the Fuel Tank(s) so that it is in good condition and working order or (ii) replace the Fuel Tank(s) with like equipment in good repair and working order, with clear title, whereupon such Fuel Tank(s) shall be subject to this Lease. No Loss shall relieve Customer from its payment obligations under this Lease.

11. Insurance. Customer, at its sole cost and expense, shall obtain (i) property insurance against the destruction of or loss to the Fuel Tank(s) for an amount at least equal to the full replacement value, ~~without deductible and without co-insurance~~, and (b) commercial general liability insurance in an amount not less than two million dollars (\$2,000,000) per occurrence and two million dollars (\$2,000,000) in the aggregate, and (c) environmental liability insurance (including clean-up costs) for pollution events with limits of liability of at least two million dollars (\$2,000,000) per occurrence and two million dollars (\$2,000,000) in the aggregate. Such insurance shall be in a form, amount, and with companies acceptable to REG and name REG as the sole named loss payee (on the property insurance policy) and name REG as an additional insured (on the commercial general liability insurance policy). Customer shall require its insurers to waive any and all rights of subrogation against REG.

12. Default. Each of the following events is an “**Event of Default**”: (a) if Customer fails to pay any amount or sum due REG within ten (10) days after the same is due and payable under this Lease, (b) if Customer fails to perform any other obligation under this Lease or in any other agreement (including a Sales Contract) with REG or with any affiliate of REG and such failure continues unremedied or without cure for ten (10) days after REG gives Customer notice specifying such failure, (c) if Customer becomes insolvent, dissolves or is dissolved, or assigns its assets for the benefit of its creditors, or any proceeding in bankruptcy, receivership, reorganization, or liquidation is instituted or filed by or against Customer, (d) if Customer suffers a material adverse change or a material deterioration in its financial condition or operations, or (e) if Customer merges or consolidates with or into another entity without REG’s consent. If an Event of Default occurs, REG may do one or more of the following: (i) recover from Customer all delinquent payments and other delinquent amounts, (ii) declare Customer in default and terminate this Lease, (iii) require Customer to immediately pay REG and declare immediately due and payable, as compensation for loss of bargain and not as a penalty, the present value of all unpaid amounts under this Lease and the Sales Contract for the remainder of the Lease Term discounted to the date of the Event of Default at the lesser of (A) a per annum interest rate equivalent to that of a U.S. Treasury constant maturity obligation (as reported by the U.S. Treasury Department) that would have a repayment term equal to the remaining unexpired Term, all as reasonably determined by REG or (B) three percent (3%) per annum, to the extent permitted by applicable law, and (iv) exercise any other right or remedy available to REG at law or in equity or under this Lease. After an Event of Default, Customer shall pay interest on all past due amounts, from the later of the date of the Event of Default or the date such amount was due until paid at an interest rate equal to twenty-one percent (21%) per annum or, if less, the maximum rate allowed by law. The remedies provided by this Lease in favor of REG shall not be exclusive, but shall be cumulative and in addition to all other remedies in REG’s favor existing at law or equity.

**Schedule B-1
Fuel Tanks and Locations**

**OPTIMUS TECHNOLOGIES, INC.
CUSTOMER AGREEMENT**

This **CUSTOMER AGREEMENT** (this "Agreement") is effective as of _____, 2019 (the "Effective Date"), by and between **OPTIMUS TECHNOLOGIES, INC.**, a Pennsylvania corporation with its principal offices at 6901 Lynn Way, Pittsburgh, PA 15208 ("OPTIMUS"), and _____, a(n) _____ with its principal offices at 515 Clark Ave. Ames, IA 50010 ("Customer"). For the purposes of this Agreement, OPTIMUS and Customer are sometimes referred to individually as a "Party" and collectively as the "Parties".

RECITALS

WHEREAS, OPTIMUS is engaged in the business of: (A) designing, developing, manufacturing, implementing, installing, and maintaining fuel systems that utilize renewable fuels; and (B) educating individuals and entities regarding such fuel systems and renewable fuels; and

WHEREAS, Customer desires to purchase the fuel systems from OPTIMUS and further engage OPTIMUS to perform the Services (as defined in **Section 1**) for and on the Customer's Original Vehicles (as defined herein), and OPTIMUS desires to sell the systems and undertake the Services upon such Original Vehicles, upon the terms, and subject to the conditions, set forth in this Agreement.

NOW, THEREFORE, in consideration of the mutual promises herein contained, and other good and valuable consideration, the receipt and sufficiency of which the Parties hereby acknowledge, and intending to be legally bound hereby, the Parties agree as follows:

1. Scope of Work.

OPTIMUS, or a subcontractor acting on OPTIMUS' behalf, shall provide to Customer the core system components and goods for the fuel systems, and all software and technology integrated into the fuel systems, as more fully described and detailed on **Exhibit A** attached hereto and made a part hereof by this reference (the "Goods"), and perform and provide those installation, implementation, and training services specifically identified on **Exhibit A** (the "Services") in accordance with the terms and conditions of this Agreement during the Term (as defined in **Section 2**). The Services will also include an "Annual Technology Subscription" and the "Installation Services" as described in **Exhibit A**. The Parties acknowledge that OPTIMUS may, if identified on **Exhibit A**, provide Goods, Services, or both Goods and Services. The provision of Goods and Services hereunder may be together referred to herein as the "Work". The Work identified in this Agreement cannot be changed or cancelled, in whole or in part, without OPTIMUS' prior written consent (except as provided in **Section 8(B)**). In the event Customer requests such change or cancellation, it shall be at OPTIMUS' sole option and subject to extra charges and changes in terms as reasonably determined by OPTIMUS in its sole discretion. If OPTIMUS elects to use subcontractors to perform any of the Work and selects the subcontractors itself, it shall be fully responsible for the acts or omissions of the subcontractors. If Customer directs OPTIMUS to work with particular subcontractors of Customer's choosing, OPTIMUS will not be responsible for the acts or omissions of such subcontractors.

2. Term.

A. The term of this Agreement shall commence on the Effective Date first set forth above and shall remain in effect until the later to occur of the following: (i) expiration of the applicable warranty period for the Goods; (ii) completion of the performance of the Services and expiration of the applicable warranty period for the Services; and (iii) expiration or termination of the Annual Technology Subscription (the "Term") unless earlier terminated pursuant to the express terms set forth in **Section 8** herein.

B. **Sections 3, 5, 6, 7, 8, 9, 10, 11, 12, 13, 15, 16, 17, 18, 19 and 21 and Exhibit D** hereof shall survive the expiration or termination of this Agreement.

3. Pricing and Payment Terms.

A. The price of the Work shall be those amounts set forth on **Exhibit B** attached hereto and made a part hereof by this reference (the "Price").

B. Unless otherwise set forth on **Exhibit B**, Customer shall make payments for the Goods and for the Services in accordance with the payment schedule set forth on **Exhibit B**. If no such milestone schedule is set forth on **Exhibit B**, OPTIMUS shall invoice that portion of the Price allocable to the Work completed during that calendar month or as otherwise set forth on **Exhibit B**.

C. Unless otherwise set forth on **Exhibit B**, Payments due to OPTIMUS shall be made by Customer no later than thirty (30) days after the date of Customer's receipt of an applicable invoice (the "Payment Period"). All payments shall be in U.S. Dollars. OPTIMUS shall be entitled to charge to Customer interest at a monthly rate equal to the lesser of one and one-half percent (1.5%) or the highest rate permitted by applicable law in the event payments are not remitted on or before their respective due dates.

D. In addition to the Price, Customer shall also be responsible for, and shall timely pay, any and all taxes, duties, assessments or charges (including, without limitation, sales taxes, if applicable) levied by any taxing authority with respect to the Goods and Services (except for income-related taxes incurred by OPTIMUS) ("Taxes"). OPTIMUS shall include the applicable Taxes on each invoice to Customer, and upon payment by Customer, shall timely remit the Taxes to the applicable taxing authority. Upon request, Customer shall supply OPTIMUS copies of evidence of payment of or exemption from any taxes, duties, assessments or charges which Customer is obligated to pay.

4. Completion, Acceptance, and Warranty.

When the Installation Services for the Customer's Original Vehicles meet the completion criteria attached as **Attachment 2** to **Exhibit A** (the "Completion Criteria"), OPTIMUS or its approved installer (the "Authorized Installer") shall so notify Customer and provide Customer a certificate certifying that the Completion Criteria have been met and the date thereof in the form attached hereto as **Attachment 1** to **Exhibit A** (such notice, the "Notice of Completion and Acceptance of Installation Services").

Customer shall either (i) reject such Notice of Completion and Acceptance of Installation Services and refuse to accept the Work, and state what Completion Criteria the Authorized Installer failed to achieve; or (ii) accept the Work and sign the Notice of Completion and Acceptance of Installation Services, with acceptance of all Goods and Services provided as part of the Installation Services being deemed to occur on the date set forth in such Notice of Completion and Acceptance of Installation Services.

If Customer rejects the Work, Authorized Installer shall (i) promptly correct the problem(s); or (ii) provide to Customer a plan and schedule for remedying the deficiencies specified in Customer's rejection if the corrections cannot occur immediately. Authorized Installer shall carry out such correction or plan at its own cost and expense, and, upon completion thereof, shall issue a new Notice of Completion and Acceptance of Installation Services.

The foregoing procedure shall be repeated until such time that either party provides a notice to terminate the specific Installation Services project, in accordance with **Section 8** hereof. To the extent Customer has not, within sixty (60) days of initial delivery of the Notice of Completion and Acceptance of Installation Services either: (x) signed and delivered to OPTIMUS the Notice of Completion and Acceptance of Installation Services, or (y) provided a notice of termination in accordance with **Section 8** hereof, the Installation Services project shall be deemed to be fully accepted by Customer.

If, following acceptance, Customer determines that the Goods or Services are not in conformity with the scope of Work set forth on **Exhibit A**, it shall immediately notify OPTIMUS in writing and pursue, if available, a permitted warranty claim in accordance with the provisions set forth in the OPTIMUS Statement of Warranty set forth in **Exhibit C** of this Agreement attached hereto and made a part hereof by this reference, which serves as the sole and exclusive warranty for the Work.

5. Limitation of Liability.

A. NOTWITHSTANDING ANY OTHER PROVISION OF THIS AGREEMENT (AND EXCEPTING OPTIMUS' INDEMNIFICATION OBLIGATIONS FOR THIRD PARTY CLAIMS, DAMAGES CAUSED BY A PARTY'S GROSS NEGLIGENCE OR WILLFUL MISCONDUCT, OR BREACHES OF **SECTION 11**), IN NO EVENT SHALL EITHER PARTY BE RESPONSIBLE OR LIABLE TO THE OTHER FOR SPECIAL, INDIRECT, INCIDENTAL, PUNITIVE OR CONSEQUENTIAL DAMAGES, HOWEVER CAUSED, EVEN IF ADVISED OF THE POSSIBILITY THEREOF.

B. OPTIMUS' MAXIMUM LIABILITY TO CUSTOMER UNDER THIS AGREEMENT, REGARDLESS OF THE THEORY ON WHICH ANY CLAIM IS BASED (INCLUDING BREACH OF WARRANTY, BREACH OF CONTRACT, TORT, NEGLIGENCE, STRICT LIABILITY OR ANY OTHER CAUSE OR BASIS) SHALL NOT EXCEED IN THE AGGREGATE \$50,000.00 US DOLLARS (USD) FOR EACH INSTALLATION OF A VECTOR SYSTEM IN A CUSTOMER'S ORIGINAL VEHICLE; PROVIDED THAT, TO THE EXTENT CUSTOMER HAS NOT MAINTAINED THE ANNUAL TECHNOLOGY SUBSCRIPTION, OPTIMUS' LIABILITY WILL BE FURTHER LIMITED TO ANY REMAINING WARRANTY PROTECTION AS SPECIFIED ON **EXHIBIT C**. FROM AND AFTER THE EARLIER TO OCCUR OF: (I) FIVE (5) YEARS FOLLOWING RECEIPT BY OPTIMUS OF THE APPLICABLE NOTICE OF COMPLETION AND ACCEPTANCE OF INSTALLATION SERVICES; OR (II) EXPIRATION OF THE MANUFACTURER'S WARRANTY APPLICABLE TO THE CUSTOMER'S ORIGINAL VEHICLES' COVERED PARTS (AS DEFINED IN **EXHIBIT C**) BUT IN NO EVENT LESS THAN ONE (1) YEAR FOLLOWING RECEIPT BY OPTIMUS OF THE APPLICABLE NOTICE OF COMPLETION AND ACCEPTANCE OF INSTALLATION SERVICES, OPTIMUS SHALL HAVE NO FURTHER LIABILITY TO CUSTOMER IN CONNECTION WITH THE GOODS OR SERVICES. THE LIMITATIONS OF OPTIMUS' LIABILITY UNDER THIS SUBSECTION SHALL NOT APPLY IN THE EVENT OF OPTIMUS' GROSS NEGLIGENCE OR WILLFUL MISCONDUCT, OR TO OPTIMUS' INDEMNIFICATION OBLIGATIONS FOR THIRD PARTY CLAIMS, OR TO OPTIMUS' BREACH OF **SECTION 11**.

6. Software; Performance Data; Annual Technology Subscription.

To the extent that the Goods include software (the "Software"), Customer hereby acknowledges and agrees that: (i) that from time to time, the Software may download and install upgrades, updates and additional features from OPTIMUS in order to improve, enhance, and further develop the Software and other components of the Work; and (ii) Customer shall not modify, reverse engineer, create derivative works of, decompile, or otherwise attempt to extract source code from OPTIMUS or from the Goods, Software or Performance Data (as defined below). Customer agrees to use the Software and other components of the Work for its internal business purposes only, and not for the commercialization of the Software or the Work and shall not (or permit any other person to) sell, resell, license, rent or lease the Software or the Work. Customer hereby assigns and/or grants to OPTIMUS any and all of its rights, rights, title and interest to any vehicle performance data collected by the Software or otherwise, which data may include, without limitation, mileage, fuel consumption, system performance, system diagnostics, technical data for use in troubleshooting, GPS-tracking refueling dates and times, and quantity and fuel type dispensed (collectively, the "Performance Data") for any business purpose whatsoever. Each party's obligations related to the Performance Data is set forth in the Performance Data Subscription Terms, which are attached hereto as **Exhibit D** and made a part of this Agreement by this reference. Customer acknowledges and agrees that Performance Data will be created as part of the Work performed, and Customer shall be bound by the Performance Data Subscription Terms, regardless of whether Customer elects to include an Annual Technology Subscription in the Goods or not. Customer agrees to use the Performance Data for its internal business purposes only, and not for the commercialization of the Performance Data and shall not (or permit any

other person to) disclose such Performance Data to any third party or sell, resell, license, rent or lease the Performance Data. Further, in the event that Customer does not elect to so include an Annual Technology Subscription, Customer may, in its sole discretion, grant OPTIMUS the right to install, at OPTIMUS' sole cost and expense, a WI-FI access point at Customer's site (in a mutually-agreed-upon location), as well as such additional software or equipment as may be necessary to enable OPTIMUS to continue to retrieve the Performance Data. Customer acknowledges and agrees that the disclosure of Performance Data in accordance with this **Section 6** in a manner that is not personally identifiable to Customer shall not be interpreted to result in such Performance Data becoming a part of the public domain for the purposes of **Section 11** or otherwise.

7. Original Vehicles and Products.

A. In the event Customer requests changes or modifications to the Work or the Original Vehicles and Other Products (as defined below) beyond what is contemplated in **Exhibit A**, such requests may result in an additional charge to Customer. OPTIMUS shall provide a quote for the additionally requested changes or modifications prior to the performance of such changes or modifications.

B. Customer acknowledges and agrees that OPTIMUS' products are unique, complex and will be interacting with and integrated into Customer's existing vehicles (the "Original Vehicles") and/or other products ("Other Products," and together with the Original Vehicles, collectively the "Original Vehicles and Other Products"). As such, even though OPTIMUS has made every attempt to determine the impact that the Work could potentially have on the Original Vehicles and Other Products, OPTIMUS is not capable of anticipating the full impact to such Original Vehicles and Other Products.

8. Termination.

A. In the event that Customer fails to perform any of its obligations pursuant to and in accordance with the terms and subject to the conditions of this Agreement, and such failure is not cured within forty-five (45) days after Customer's receipt of OPTIMUS' written notice alleging such failure, OPTIMUS may terminate this Agreement by providing written notice to Customer; provided that, OPTIMUS may immediately terminate this Agreement upon breach by Customer of the terms of **Section 6** or **Section 11** hereof. If such a termination occurs, OPTIMUS shall be entitled to receive and Customer shall be required to pay: (i) OPTIMUS' costs and expenses, including, without limitation, costs of goods, labor (both direct and third party costs) and services incurred with respect to the performance of Work up through the date of such termination; and (ii) an additional termination fee equal to 25% of the total Price paid by Customer up to the date of termination, should the termination occur prior to completion and acceptance of Installation Services; which the parties acknowledge is not intended as a penalty but is a reasonable approximation of the damages that would be suffered by OPTIMUS. OPTIMUS will invoice Customer for such costs, expenses and fees within fifteen (15) days following written notice of termination, and Customer shall pay such invoice within thirty (30) days of receipt thereof plus interest as set forth in **Section 3(C)** hereof. In addition to the foregoing, OPTIMUS shall also be entitled to pursue any and all remedies available to it at law or in equity.

B. In the event that OPTIMUS fails to perform any of its obligations in accordance with the terms and subject to the conditions of this Agreement, and such failure is not cured within forty-five (45) days after OPTIMUS' receipt of Customer's written notice alleging such failure, Customer may terminate this Agreement by providing written notice to OPTIMUS. Subject to the limitations of liability contained in this Agreement, Customer shall also be entitled to pursue any and all remedies available to it at law or in equity.

9. Excusable Delays; Unforeseen Events.

OPTIMUS shall not be responsible or liable for a failure to perform the Work or delays in the performance of Work hereunder arising from: (i) acts of God or a public enemy; (ii) acts of the Government of the United States or any political sub-division or any department or regulatory agency thereof or entity created thereby; (iii) act of any person or entity engaged in subversive activity, sabotage or terrorism; (iv) wars or riots; (v) fires, floods, explosions or other catastrophes; (vi) epidemics and quarantine restrictions; (vii) third-party strikes, slowdowns, lockouts or labor stoppages or shortages or disputes of any kind; (viii) embargoes; (ix) unusually severe weather; (x) delays of a supplier due to any of the above causes or events; or (xi) other causes or events beyond the reasonable control of OPTIMUS in failing to perform hereunder; provided, however, that if any of the events listed above lasts for more than ninety (90) days after receipt of notice to OPTIMUS by Customer, Customer may terminate this Agreement without penalty at the end of such ninety (90) day period and OPTIMUS shall promptly refund to Customer any money paid by Customer for Work that was delayed as a result of the same. The foregoing shall be in addition to, and not in limitation of any excuses for non-performance available to OPTIMUS under the Uniform Commercial Code or any other applicable law.

10. Independent Contractor.

The Parties agree that OPTIMUS shall at all times serve as an independent contractor under this Agreement, and not as an agent, servant or employee of Customer.

11. Confidentiality; Ownership of Technology.

A. The Parties acknowledge that in connection with the performance of this Agreement, each Party will be receiving (the "Recipient") from the other Party (the "Discloser") information that is proprietary or confidential in nature to the Discloser.

B. For purposes of this Agreement, the term "Confidential Information" shall include any and all information, whether oral, written or in electronic form, disclosed or communicated by the Discloser to the Recipient including, but not limited to, information relating to the Discloser's technology, patents, trade secrets, other intellectual property, customer lists, supplier lists, supply and logistics information, methods, processes, manufacturing techniques, research and development information, innovations, ideas, changes or modifications to its products, training and instructional materials, specifications, drawings and technical specifications. Confidential Information shall not include any information that the

Recipient can demonstrate: (i) enters into or is already in the public domain without a breach of this Agreement; (ii) is independently developed by the Recipient without using the Discloser's Confidential Information; or (iii) is known or received by the Recipient from a third party having no obligation not to disclose the Confidential Information. Without otherwise limiting the scope of Customer's Confidential Information, only Performance Data which is specifically identifiable to Customer is included in Customer's Confidential Information.

C. Each Party agrees that Confidential Information is exclusively owned by the applicable Discloser. Each Party agrees to maintain the Confidential Information it receives from the Discloser in confidence, and not to disclose the Confidential Information, or any part thereof, to any third party without the prior express written consent of the Discloser. The Recipient agrees to protect the Discloser's Confidential Information in a reasonable manner. Each Party further agrees that upon termination or expiration of this Agreement, it will promptly return in the same good condition as when received, reasonable wear and tear from normal use excepted, all of the Discloser's Confidential Information and other information not otherwise disposed of, in accordance with the Discloser's instructions.

D. The Recipient agrees that: (i) improper use or disclosure of the Discloser's Confidential Information shall cause irreparable harm to the Discloser and monetary damages for such improper use or disclosure will be inadequate and will not give full and sufficient relief to the Discloser; and (ii) if such improper use or disclosure occurs, the Discloser shall have, in addition to any and all other remedies available under this Agreement or in equity or law, the right to equitable relief (by way of specific performance and/or injunctive relief and without the necessity of posting a bond) to prevent any further improper use, disclosure, breach or threatened breach.

E. The Parties acknowledge and agree that all of OPTIMUS' product technology including, without limitation, its patents, its Confidential Information and any innovations, new developments, enhancements or products developed before, during or after the performance of the Work, shall remain the sole and exclusive property of OPTIMUS. Customer shall not use, and is hereby prohibited from using, any of the foregoing product technology, OPTIMUS' Confidential Information, OPTIMUS' products or the Work for any purpose whatsoever other than for the specific and intended use contemplated by this Agreement.

12. Customer's Original Vehicles.

A. If Customer sells, conveys, assigns or otherwise transfers (collectively, "Transfer") title to any of its personal property (including, without limitation, any Original Vehicles) to which all or any part of the Work or Goods are affixed, the remaining duration of the Covered Parts Warranty Period and the Vector System Warranty Period, if any, shall transfer to the buyer of the property but only if such buyer executes an OPTIMUS Warranties Transfer Certificate (to be provided upon request) certifying that it is bound by all of the terms, conditions, requirements, obligations and limitations of the OPTIMUS Warranty Program and Warranty including, without limitation, the limitations set forth in **Exhibit C** and limitations of liability set forth in **Section 5** of this Agreement; provided that, any buyer must install local wi-fi access at its own cost. If the Vector System Warranty and the Covered Parts Warranty have expired or the buyer fails to execute the OPTIMUS Warranties Transfer Certificate, then the Goods affixed to the transferred property shall be Transferred to the buyer in their "AS IS, WHERE IS" condition and OPTIMUS shall have no post-Transfer obligations or liabilities to such buyer; provided that, any such buyer shall continue to be subject to the provision of **Section 11** relating to confidentiality and OPTIMUS' ownership of product technology.

B. Customer shall, upon reasonable request, provide OPTIMUS with a commercially reasonable number of service records associated with vehicles to which all or any part of the Work or Goods are affixed or associated ("Service Records"). OPTIMUS may share Service Records with its contractors upon the prior written approval of Customer, which approval Customer shall not unreasonably withhold, condition or delay.

C. OPTIMUS may affix certain decals bearing OPTIMUS-related logos (the "Decal(s)") on Customer's vehicles to identify that such vehicles have been equipped with the Goods, are operating on OPTIMUS-approved fuel, or both, as applicable upon Customer's prior approval of the size and location of such Decals, which approval Customer shall not unreasonably withhold, condition or delay.

13. Indemnification.

Each Party (the "**Indemnitor**") agrees to defend, indemnify and hold the other Party, including its affiliates, and all of their respective officers, directors, agents and employees (each, an "**Indemnitee**"), harmless from and against any and all claims, demands, liabilities, losses, damages, actions, judgments, costs, expenses, fines and reasonable attorneys' fees (collectively, "**Claims**") asserted by a third party against an Indemnitee arising out of, related to or in connection with: (A) any breach of this Agreement by the Indemnitor; (B) any infringement or misappropriation of any patent, copyright, trade secret, trademark, service mark, trade name, proprietary information of other intellectual property rights alleged to have occurred because of the work; (C) any damage to or loss or destruction of any real or tangible personal property in the possession or under the control of the Indemnitor; (D) the Indemnitor's grossly negligent acts or omissions and/or willful misconduct in performing the Work; (E) the death or bodily injury of any agent, employee, subcontractor, customer, business invitee or business visitor of the Indemnitor; or (F) any violation by the Indemnitor of any applicable law.

Any Indemnitee seeking indemnification for a Claim made by a third party under this Section shall give prompt written notice to the Indemnitor of such Claim; provided, however, the failure by an Indemnitee to give such notice shall not relieve the Indemnitor of its obligations under this Section, except to the extent that the Indemnitor is materially prejudiced as a result of such failure. In addition, the Indemnitee shall allow the Indemnitor to direct the defense and settlement of any such Claim, with counsel of the Indemnitor's choosing, and shall provide the Indemnitor, at the Indemnitor's expense, with such information and assistance as is reasonably necessary for the defense and settlement of the Claim. The Indemnitor shall not be liable for any settlement of an action effected without its written consent (which consent shall not be unreasonably withheld or delayed), nor shall the Indemnitor settle any such action that affects the Indemnitee's rights or interests without the written consent of the Indemnitee. The Indemnitor shall not consent to the entry of any judgment or enter into any settlement that does not include as an unconditional term thereof the giving by the claimant or plaintiff to the Indemnitee a release from all liability with respect to the Claim.

14. Notices.

All notices and invoices given pursuant to or in accordance with this Agreement shall be in writing and transmitted by personal delivery, overnight express mail or facsimile (evidenced by printed confirmation of delivery). Any such notice or communication hereunder, and every payment hereunder, shall be sent to the Parties at the following addresses, or such other address as either Party may designate from time to time:

If to OPTIMUS:

Optimus Technologies, INC
6901 Lynn Way
Pittsburgh, PA 15208
Attn: Colin Huwyler, CEO

If to Customer:

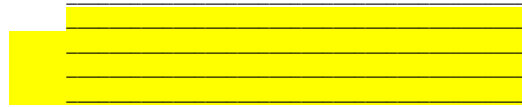

15. No Waiver of Rights.

A failure by either Party to assert its right(s) under this Agreement shall not be deemed a waiver of such right(s), nor shall any such waiver be implied. No waiver by one (1) of the Parties of any breach of this Agreement, or with respect to any right under this Agreement, shall extend to or affect any subsequent breach or right, either of a like or different kind, or impair any right consequent thereon.

16. Assignment.

This Agreement shall not be assigned, transferred or delegated, by either party in whole or in part, by operation of law or otherwise, without the prior written consent of the other party, which consent shall not be unreasonably withheld, conditioned or delayed.

17. Severability of Provisions.

The invalidity under applicable law of any provision(s) of this Agreement shall not affect the validity of any other provision(s) of this Agreement, and in the event that any provision(s) hereof be determined to be invalid or otherwise illegal, the Parties intend that this Agreement shall remain effective and shall be construed in accordance with its terms as if the invalid or illegal provision(s) was not contained herein.

18. Power and Authority.

Each Party represents and warrants to the other Party that it has the requisite power and authority to execute, deliver and perform its obligations under this Agreement.

19. Choice of Law; Dispute Resolution; Waiver of Jury Trial.

This Agreement shall be construed by and interpreted in accordance with the laws of the State of Iowa, without regard to its conflict of laws principles. The Parties consent to the exclusive jurisdiction of the federal and state courts located in Story County, Iowa. EACH OF THE PARTIES HERETO IRREVOCABLY WAIVES ALL RIGHT TO TRIAL BY JURY IN ANY ACTION, PROCEEDING OR COUNTERCLAIM (WHETHER BASED ON CONTRACT, TORT OR OTHERWISE) ARISING OUT OF OR RELATING TO THIS AGREEMENT OR THE ACTIONS OF THE PARTIES IN THE PERFORMANCE OR ENFORCEMENT HEREOF.

20. Counterparts; Section Headings.

This Agreement may be executed in counterparts, each of which shall be deemed to be an original, but all of which taken together shall constitute one (1) and the same instrument. The Section headings of this Agreement are for convenience of reference only and shall not affect the construction or interpretation of any provision(s) hereof.

21. Entire Agreement; Amendments; Construction.

This Agreement, including the Recitals hereof and all Exhibits hereto, which are hereby fully incorporated into this Agreement, constitutes the entire agreement and understanding by and between the Parties regarding the subject matter hereof, and there are no other representations, agreements or understandings, oral or written, express or implied, between the Parties relating thereto. This Agreement, including, without

limitation, any Exhibit hereto, may only be amended by means of a writing subsequently executed by both Parties that states that it is intended as an amendment to this Agreement. In the event of a conflict between this Agreement and any attached Exhibits, the Exhibits shall control.

IN WITNESS WHEREOF, the Parties, or the authorized representatives of the Parties, hereto have executed this Customer Agreement as of the Effective Date first set forth above.

OPTIMUS TECHNOLOGIES, INC.

By: _____

Name: Colin Huwyler

Title: CEO

By: _____

Name:

Title:

EXHIBIT A

DESCRIPTION OF THE WORK; SCOPE OF WORK

The Goods shall consist of the following:

Vector System Design: Optimus will design components for five (5) Vector Systems.

Vector System: The Vector System is comprised of multiple components. Components created from designs may vary depending on the specific vehicles but may include an auxiliary fuel tank with mounting brackets or tank adaptor kit, in-tank heat exchanger, brackets and associated parts. Additional components will include the Vector Manifold (fuel filter housing and element assembly, temperature and pressure sensors), solenoid valves, fuel line, heat exchanger, heater hose, electronic control unit, display, wiring harness, software, and all the necessary fittings, connectors, and clamps.

Vector System for the Following Vehicles:

Vehicle #	Engine Type	Year	Make	Model	VIN
Ames-933		2014	International	7300	
Ames-934		2017	International	Work Star	
Ames-967		2017	International	Work Star	
Ames-977	Cummins L9	2018	International	7500	
Ames-979	Cummins L9	2018	International	7500	

Manuals: Customer will receive an electronic copy of the Product Manual for each Vector System purchased.

The Services shall consist of the following:

Installation Services and Completion Testing: An Approved Installer will install and test the Vector System on the Customer's Original Vehicle. Installation and Completion Testing may take place at Customer provided facility or other location as agreed by the Parties. In the event that a specific piece needs to be modified once test fitting has occurred, modification will take place at Optimus' or a third-party facility depending upon the modification's requirements and the capability of that facility to provide for those requirements. Upon completion of Installation Customer must, within seven (7) days, submit to OPTIMUS the "Notice of Completion and Acceptance of Installation Services" form for each respective Original Vehicle.

Annual Technology Subscription: The project costs include a one (1) year Annual Technology Subscriptions for each vehicle. The subscription consists of the following for each vehicle:

- Access to performance data captured from the vehicle, that at may include: estimated daily fuel consumption (by type – biofuel or diesel); operational run time (diesel vs. biofuel warm-up vs. biofuel); fuel tank levels; and filter pressure levels.
- No-charge access to Optimus software upgrades, and
- No-charge access to Optimus technical phone support. If outside of the Vector System Warranty Period or not part of the Annual Technology Subscription, any support that is agreed to be provided by OPTIMUS will be provided at its then applicable costs.
- The Annual Technology Subscription is governed by the Performance Data Subscription Terms ("PDST"), attached to the Customer Agreement as Exhibit D, and incorporated by reference therein. Additional terms related to the Annual Technology Subscription are set forth in the PDST.

Customer Training: All training will be provided by an Authorized Installer. Each Customer will receive one (1), two (2) hour on-site training session to include how to operate, adjust, and maintain the installed equipment. Additional training is available at the Customer's cost. As part of this training, Customer's personnel will be instructed on the safety of using the installed equipment on the vehicle, including that the vehicle engine may continue running for several minutes after the ignition of such vehicles are turned to the "OFF" position. As such, Customer agrees that it shall not cause or otherwise permit the use of its vehicles in a manner contrary to that provided in such training, which includes, without limitation, PROHIBITING THE DRIVER OF SUCH VEHICLES FROM LEAVING SUCH VEHICLE UNATTENDED WHILE THE ENGINE RUNS.

Technician Training: Customer's technician, which may include technicians from the Customer's respective dealership or service center, will have the option to assist in the Vector system installation. Upon conclusion of the installation, Customer's technicians will be expected to demonstrate a basic knowledge/understanding of the Vector system.

**ATTACHMENT 1 TO EXHIBIT A
NOTICE OF COMPLETION AND ACCEPTANCE OF INSTALLATION SERVICES**

Date of Completion:	
Authorized Installer:	
Customer Name:	
Vehicle Number:	
VIN:	
Odometer Reading:	
Vector Manifold Serial #:	
Fuel Tank Serial #:	

Ladies and Gentlemen:

This Notice of Completion and Acceptance of Installation Services (the "Notice") is being provided by the Authorized Installer identified above, to the Customer, in connection with the Installation Services provided for the Customer's Original Vehicles, pursuant to that certain Optimus Technologies, Inc. Customer Agreement dated _____ (the "Agreement").

By its signature below, the Authorized Installer certifies that it has completed all deliverables pertaining to the above identified Original Vehicle and Vector System under the Completion Criteria provided on Attachment 2 to Exhibit A, in accordance with the specifications and terms and conditions of the Agreement. We ask for your concurrence with your signature below.

Authorized Installer Signature:

Company Name: _____

Primary Installer Name: _____

Signature: _____

Title: _____

Proof of Acceptance:

- Customer hereby certifies that the Goods and Services pertaining to the above identified Original Vehicle and Vector System provided by Authorized Installer are hereby accepted, and that all deliverables under the Compliance Criteria have been completed in full.
- The Goods and Services pertaining to the above identified Original Vehicle and Vector System are not accepted and the deliverables under the Compliance Criteria have not been completed in full. The following items remain uncompleted:

Customer Signature:

Company Name: _____

Representative Name: _____

Signature: _____

Title: _____

**ATTACHMENT 2 TO EXHIBIT A
COMPLETION CRITERIA**

- Fuel Tank**
 - Verify all parts are accounted for and installed on the tank.
 - Inspect tank placement and bracketing and ensure no interference with other components.
 - Verify that tank straps have been tightened to the proper specification.
 - Inspect all tank electrical harnesses to ensure they are properly secured and verify all connections are properly seated.
 - Verify all fittings on the tank are properly tightened, hoses are secured, and that there are no fluid leaks.

- Manifold, ECU, and PDM**
 - Verify all parts are accounted for and installed on the manifold, ECU, PDM, and any brackets.
 - Verify that the manifold, ECU, PDM, and any bracket mounting bolts have been tightened to the proper specifications.
 - Inspect all manifold, ECU and PDM electrical harnesses to ensure they are properly secured, verify all connections are properly seated, and verify installation of required fuses/relays and bus bars in the PDM.
 - Verify all fittings on the manifold are properly tightened, hoses are secured, and that there are no fluid leaks.
 - Verify appropriate biodiesel fuel system pressure and ensure pressure regulator locknuts have been tightened.

- User Interface, Ignition Integration, and Data Collection Module (if applicable)**
 - Verify all parts are accounted for and installed on the user interface, ignition integration, and data collection module.
 - Inspect all user interface, ignition integration and data collection module harnesses to ensure they are properly secured, verify all connections are properly seated.

- Valves**
 - Verify all parts are accounted for and installed on the valves.
 - Verify that the valves and any bracket mounting bolts have been tightened to the proper specifications.
 - Inspect all valve electrical harnesses to ensure they are properly secured and verify all connections are properly seated.
 - Verify proper actuation of all valves.
 - Verify all fittings on the valves are properly tightened, hoses are secured, and that there are no fluid leaks.

- Hoses**
 - Verify correct flow path, connections, and routing of all hoses.
 - Inspect all hoses and verify they are properly secured, there is no interference, all connections are properly tightened, and that there are no fluid leaks.
 - Verify any sheathing, if applicable, is installed.

- Wiring Harnesses**
 - Verify main system power has been securely connected to the 12v battery source.
 - Inspect all harnesses and verify they are properly secured, there is no interference, all connections are properly seated.
 - Verify any sheathing, if applicable, is installed.

- Engine Integration**
 - Verify correct flow path, connections, and routing of all hoses.
 - Verify all integration parts are accounted for and installed (if applicable).
 - Inspect all hoses and verify they are properly secured, there is no interference, all connections are properly tightened, and that there are no fluid leaks.
 - Verify any sheathing, if applicable, is installed.

- Operational Test**
 - Verify fuel level is appropriate for testing of both diesel and biodiesel systems.
 - Manually prime diesel and biodiesel fuel systems.
 - Operate engine at idle for a minimum of 15 minutes and verify that there are no fluid leaks.
 - Verify appropriate operating conditions/states, sensor reporting, data collection module connection, and CAN Bus connection via Optimus software.
 - Manually verify/test operation of biodiesel fuel system components via Optimus software overrides.
 - With system in normal operating state ensure engagement of biodiesel fuel system via 5 test cycles.
 - Verify proper purge cycles and engine shutdown via emergency stop function.
 - Operate vehicle for in-use test cycle to verify normal operation of biodiesel fuel system (if applicable).

EXHIBIT B

PRICING INFORMATION; MILESTONE SCHEDULE; PAYMENT DUE DATES

City of Ames Budget (Estimate)

DESCRIPTION	QTY	UNIT PRICE	EXTENDED PRICE
Vector System Base Cost	5	\$ 5,000	\$ 25,000
Vector Control System Package	5	\$ 2,250	\$ 11,250
Engine Integration Kit	5	\$ 1,250	\$ 6,250
Optimus Biodiesel D-Tank & Bracket Package 70 Gallons	5	\$ 1,417	\$ 7,085
Optimus Technology Subscription (per year)	5	\$ 500	\$ 2,500
Installation (hours)	100	\$ 100	\$ 10,000
Travel Expenses	1	\$ 3,104	\$ 3,104

TOTAL: \$ 65,189

All goods are FOB manufacturers' facility

OPTIMUS shall be reimbursed for reasonable travel expenses incurred by OPTIMUS in connection with the Work (the "Travel Expenses") if part of the original estimate set forth in this **Exhibit B**. If Travel Expenses exceed those set forth above, OPTIMUS will only be reimbursed if preapproved in writing by Customer and if documented and evidenced by receipts, invoices or other evidence reasonably acceptable to Customer.

OPTIMUS shall be reimbursed for additional expenses incurred by OPTIMUS in connection with the Work (the "Miscellaneous Expenses") if preapproved in writing by Customer.

Milestones (estimated business days):

- Engine integration system design (15 business days from execution of Customer Agreement)
- Fuel tank package submitted for approval (5 business days from completion of previous milestone)
- Manufacturing of Optimus Vector systems (15 business days from Customer tank package approval)
- Installation of first Optimus Vector systems (20 business days from completion of previous milestone)
- Customer acceptance of first Optimus Vector system (7 business days from completion of Vector installation)
- Customer training and review of provided materials (5 business days from completion of first Vector installation)
- Setup of Customer Technology Subscription portal (10 business days from completion of first Vector installations)
- Installation of second through fifth Optimus Vector systems (30 business days from Customer acceptance of first Optimus Vector system)
- Customer acceptance of second through fifth Optimus Vector systems (7 business days from completion of each Vector installation)

Payment Schedule:

- Optimus Vector Systems Costs due on receipt of project invoice
- Installation and Travel Expenses due on receipt of project closeout invoice

EXHIBIT C

OPTIMUS STATEMENT OF WARRANTY

I. Vector System Warranty

A. For a period of two (2) years from receipt by OPTIMUS of the signed Notice of Completion and Acceptance of Installation Services accepting the Work (“Vector System Warranty Period”), OPTIMUS warrants that the Goods shall be free from defects in material and workmanship and that the Services will materially conform to the scope of Work and specifications, if any, set forth on **Exhibit A** to this Agreement, and the Completion Criteria (the “Vector System Warranty”). The foregoing warranty excludes disposable or consumable Goods, including, without limitation, fuel lines, filters, clamps, screws, etc. as well as rust deterioration of the Goods. Goods sold to Customer, but not manufactured by OPTIMUS, do not carry a warranty from OPTIMUS and are hereby disclaimed. All Goods manufactured by OPTIMUS’ vendors and other third parties and sold as part of OPTIMUS’ Work shall carry the warranties given by the applicable vendors and third parties, which warranties OPTIMUS, at its option, will either assign or make available to Customer.

B. When delivered, all Goods shall be in compliance with the United States Environmental Protection Agency (the “EPA”), as defined by its then-current guidelines, and all other applicable law. Customer hereby acknowledges and agrees that such EPA guidelines may require OPTIMUS to affix an EPA supplemental emission control information label (the “EPA Label”) to the engine block of Customer’s vehicles. Customer further agrees that it shall be responsible to ensure that any and all required EPA Labels remain affixed to such vehicles and, in the event that such EPA Labels are no longer so affixed, to immediately notify OPTIMUS, in which case OPTIMUS shall replace such EPA Labels within seven (7) business days of its receipt of such notification by Customer.

C. Should the Goods, within the applicable Vector System Warranty Period, fail to materially conform to the scope of Work and specifications, if any, set forth on **Exhibit A** to this Agreement, or the Completion Criteria, Customer shall at its cost return the Goods to OPTIMUS, or to a facility or location designated by OPTIMUS, for repair or replacement, and bear the risk of loss while the Goods are in transit. In the event of a valid warranty claim, OPTIMUS shall reimburse Customer for reasonable shipping costs incurred to return the Goods for repair or replacement. OPTIMUS shall pay the shipping charges to return the Goods to Customer and bear the risk of loss during transit, unless such non-conformity was not covered by the Vector System Warranty. In such an event, OPTIMUS shall immediately notify Customer and request instructions regarding disposition. Customer agrees that its sole and exclusive remedy for a breach of the Vector System Warranty is limited to the correction of the non-conformity by repair or replacement and/or reperformance of the Services.

D. The Vector System Warranty shall NOT apply to: (i) Goods which have defects resulting from improper or inadequate maintenance or installation, unauthorized modification or misuse, or operation(s) outside of the environmental specifications by anyone other than OPTIMUS; and (ii) Goods that have been subject to mishandling, misuse, neglect, improper testing, repair, alteration, damage, assembly or processing by anyone other than OPTIMUS, that alters physical or electrical properties. Further, Customer hereby acknowledges and agrees that the Vector System Warranty shall be invalidated if: (a) Customer uses any fuel in connection with the Goods other than that which meets OPTIMUS’ required specifications set forth on **Attachment 1 to this Exhibit C**; (b) any of the Goods are not installed by OPTIMUS-trained and certified technicians; or (c) Customer has not purchased and maintained, during the Vector System Warranty Period, the Annual Technology Subscription for each vehicle.

OPTIMUS’ MAXIMUM LIABILITY TO CUSTOMER FOR ANY VECTOR SYSTEM WARRANTY CLAIM SHALL NOT EXCEED, PER EACH INSTALLATION OF AN OPTIMUS VECTOR SYSTEM IN A CUSTOMER ORIGINAL VEHICLE, FOR GOODS, THE AGGREGATE AMOUNT OF: (i) \$10,000 US DOLLARS (USD) DURING THE FIRST YEAR OF THE VECTOR SYSTEM WARRANTY PERIOD, AND (ii) \$5,000 US DOLLARS (USD) DURING THE SECOND YEAR OF THE VECTOR SYSTEM WARRANTY PERIOD. CLAIMS FOR WARRANTY OTHER THAN THE VECTOR SYSTEM WARRANTY ARE SUBJECT TO THE LIMITATION OF LIABILITY SET FORTH IN **SECTION 5** OF THE AGREEMENT.

II. Covered Parts Warranty

A. For a period of the sooner to occur of (a) five (5) years or (b) the expiration of the applicable original equipment warranty offered by the manufacturer on the Covered Parts (as defined in **Section II(B)** below), not to include third-party extended warranties, but in no event less than one (1) year, from receipt by OPTIMUS of the signed Notice of Completion and Acceptance of Installation Services accepting the Work (herein, the “Covered Parts Warranty Period”), OPTIMUS hereby warrants damage caused by the Goods to the Covered Parts installed in the Customer’s Original Vehicle(s), subject always to the limitations set forth herein (the “Covered Parts Warranty”).

B. The Covered Parts Warranty includes only the following components: The Original Vehicle’s Engine, Fuel System and Exhaust Components (collectively, the “Covered Parts”).

C. Should a Covered Part require repair or replacement during the Covered Party Warranty Period, the Customer shall promptly notify OPTIMUS of such Covered Parts Warranty claim. If requested by OPTIMUS, Customer shall promptly provide to OPTIMUS all reasonable information necessary to evaluate the claim including, without limitation, access to any Customer or third-party representative who may have evaluated and inspected the Covered Parts, documentation of any prior repairs or modifications to the Covered Parts and physical access to the Covered Parts for independent evaluation and inspection. If the damaged parts are covered by the Covered Parts Warranty, Optimus shall repair or replace the affected Covered Parts, or shall cause the affected Covered Parts to be repaired or replaced, all at its sole cost and expense (subject always to the limitations set forth in this Agreement). Customer agrees that its sole and exclusive remedy for a Customer’s Covered Parts Warranty claim is the remedy of the Covered Parts by repair or replacement in OPTIMUS’ sole reasonable discretion. If the damaged parts are not covered by the Covered Parts Warranty, OPTIMUS has the right to deny the Customer’s Covered Parts Warranty claim. If Customer has a right to recover its damages against an unrelated third party for any cost that OPTIMUS has paid to evaluate the claim, Customer, if requested by OPTIMUS, shall assign such rights to OPTIMUS. Customer agrees to provide reasonable assistance OPTIMUS to enforce Customer’s rights against any such third party who may be responsible to Customer for the costs of repairs OPTIMUS provided.

D. OPTIMUS' MAXIMUM LIABILITY TO CUSTOMER FOR ANY WARRANTY CLAIM UNDER THE COVERED PARTS WARRANTY SHALL NOT EXCEED, PER EACH INSTALLATION OF AN OPTIMUS VECTOR SYSTEM IN A CUSTOMER ORIGINAL VEHICLE, THE AGGREGATE AMOUNT OF \$50,000 US DOLLARS (USD).

III. Warranty Invalidated; Customer Requirements

A. The Vector System Warranty and the Covered Parts Warranty shall be invalidated and of no force and effect immediately in the event that (i) Customer has not completed the "Notice of Completion and Acceptance of Installation Services" form for each Original Vehicle within seven (7) days of its receipt and acceptance of the Work from OPTIMUS; (ii) Customer uses any fuel in connection with the Goods other than that which meets OPTIMUS' required specifications set forth on **Attachment 1 to Exhibit C** to this Agreement; (iii) Customer has an expired Annual Technology Subscription license, as defined in **Exhibit A** to this Agreement; (iv) Original Vehicle(s) aftertreatment assemblies are not maintained to the specifications originally set forth by the manufacturer or the manufacturer of the Original Vehicles the ("OEMs"); (v) Original Vehicle(s) engine oil, oil filter, and/or fuel filters are not replaced upon the later to occur of (a) the OEM recommended service interval; or (b) a Customer-specific OEM-approved service interval; (vi) Customer does not send oil analyses for each of its vehicles to OPTIMUS within thirty (30) days after every oil change; (vii) the Goods or the Covered Parts are modified or maintained by Customer or a third party in a manner that is inconsistent with Optimus's or the OEMs' service and operating manuals; (viii) Customer installs or uses component parts not authorized or approved by Optimus or the OEMs; (ix) the Goods or the Covered Parts are damaged or destroyed in a vehicle accident or wreck; (x) in relation to the Covered Parts Warranty, the manufacturer's warranty on the applicable Original Vehicle is expired after one (1) year from the date of receipt by OPTIMUS of the signed Notice of Completion and Acceptance of Installation Services accepting the Work; and/or (xi) the Customer's unauthorized modification, misuse, mishandling, neglect, improper or inadequate maintenance or operation of the Goods or Covered Parts.

IV. Limitation of Liability; Disclaimer

A. OTHER THAN THE WARRANTIES SPECIFICALLY SET FORTH IN THIS **EXHIBIT C**, OPTIMUS MAKES NO OTHER WARRANTIES, AND HEREBY DISCLAIMS ANY AND ALL OTHER WARRANTIES, EXPRESS AND IMPLIED, INCLUDING, WITHOUT LIMITATION, ALL IMPLIED WARRANTIES OF MERCHANTABILITY AND IMPLIED WARRANTIES OF FITNESS FOR A PARTICULAR PURPOSE, REGARDING, OR RELATING TO, THE WORK. EXCEPT AS SET FORTH IN **SECTION 12** OF THIS AGREEMENT, ANY AND ALL WARRANTIES SET FORTH WITHIN THIS AGREEMENT EXTEND TO CUSTOMER ONLY AND NOT TO ANY THIRD PARTIES.

B. CLAIMS FOR WARRANTY OTHER THAN THE VECTOR SYSTEM WARRANTY AND THE COVERED PARTS WARRANTY ARE SUBJECT TO THE LIMITATION OF LIABILITY SET FORTH IN **SECTION 5** OF THE AGREEMENT.

**ATTACHMENT 1 TO
EXHIBIT C
OPTIMUS REQUIRED FUEL SPECIFICATIONS**

The Optimus System requires the following base fuel quality specifications (“Level I Fuel Quality Specification(s)”) Minimum ASTM D6751 specifications with the following substitutions:

Property	ASTM Limit	Optimus Limit	Units	Method
Water & Sediment:	0.05	0.02	% volume, max	D2709
Oxidation Stability (110 °C):	3	6	Hours, min	EN 15751
Sodium & Potassium Combined:	5	-	ppm, max	EN 14538
Calcium & Magnesium Combined:	5	-	ppm, max	EN 14538
Sodium, Potassium, Calcium, & Magnesium Combined:	-	4*	ppm, max	EN 14538
Phosphorus:	10	4*	ppm, max	D4951

*4 ppm acceptable per individual fuel load; however, the weighted average for all biodiesel utilized must be 2 ppm or less.

If any updates to the fuel quality specifications are required, Optimus will provide these specifications to customer with 90 days’ notice.

EXHIBIT D
PERFORMANCE DATA SUBSCRIPTION TERMS

These Performance Data Subscription Terms (“PDST”) describe Customer’s rights and obligations with respect to Performance Data and as a purchaser of Optimus’ Annual Technology Subscription (which includes access to Performance Data, access to Software upgrades, and access to Optimus technical support services), as such terms are further described in the Customer Agreement (the “Subscription Services”). All capitalized terms not otherwise defined in these PDST shall have the meanings ascribed to them in the Customer Agreement.

1. Subscription Services; Restriction on Use; Ownership.

1.1. **Subscription; License.** In connection with the Work provided under the Customer Agreement, Optimus collects and retains Performance Data related to a Customer’s vehicle that is covered by the Customer Agreement. Customer hereby assigns and/or grants to OPTIMUS any and all of its rights, title and interest to any vehicle Performance Data collected by the Software or otherwise. Subject to the terms and conditions of these PDST and the Customer Agreement, Optimus hereby grants to Customer a limited, non-exclusive, non-transferable, revocable right to download, access, and use the Performance Data solely in connection with Customer’s internal business purposes.

1.2. **Compliance with Laws.** In connection with its use of the Performance Data, both Customer and OPTIMUS shall (i) comply with all applicable national, international, federal, state, and local laws, rules, and regulations and self-regulatory guidelines, including, without limitation, laws relating to privacy and unfair business practices; and (ii) establish, implement, and maintain reasonable physical, electronic, and procedural safeguards to maintain the security and confidentiality of the Performance Data.

1.3. **Restrictions on Use of the Data.** Customer shall not (and shall not authorize or knowingly permit any third party to make) any use or disclosure of the Performance Data without OPTIMUS’ prior written consent or otherwise expressly permitted under these PDST. Without limiting the foregoing, Customer shall not (and shall not authorize or knowingly permit any third party to): (i) publish the Performance Data, in whole or in part; or (ii) resell, distribute, or sublicense the Performance Data.

1.4. **Optimus Obligations.** OPTIMUS shall not disclose any Performance Data that identifies Customer to any third party without Customer’s prior written consent. OPTIMUS shall be entitled to freely disclose Performance Data that does not include any personally identifiable information of Customer.

1.5. **Ownership.** Consistent with and subject to the terms of the Customer Agreement, Optimus owns and shall own all rights, title, and interest in and to the Performance Data. Customer has no rights with respect to the Performance Data other than those expressly granted hereunder.

2. Subscription Fee; Term; Cancellation of Subscription Services.

2.1. **Subscription Fee.** The annual cost of the Subscription Services for each PDST Term shall be described in **Exhibit B** of the Customer Agreement (“Annual Subscription Fee”).

2.2. **Term.** The “Initial PDST Term” for each vehicle is one (1) year from the receipt by OPTIMUS of the Notice of Completion and Acceptance of Installation Services. The Initial PDST Term will automatically renew for subsequent annual renewal terms (“Renewal Terms”) on the expiration of the then current Initial PDST Term or Renewal Term. Customer will be provided a notice of renewal sixty (60) days in advance of the expiration of the Initial PDST Term and each Renewal Term (collectively, the Initial PDST Term and subsequent Renewal Terms shall be the “PDST Term”). OPTIMUS will then send a PDST Term renewal invoice forty-five (45) days prior to the commencement of a Renewal Term. Customer shall pay all invoices in full within thirty (30) days of receipt.

2.3. **Cancellation of Subscription Services.** Customer may cancel the Subscription Services at any time by providing a written notice of non-renewal no less than thirty (30) days prior to the expiration of the PDST Term; provided that, Customer acknowledges that failure to maintain the Subscription Services will serve to void the Vector System Warranty and the Covered Parts Warranty. Failure to renew the Subscription Services will also result in the Customer losing access to any Performance Data from the OPTIMUS system, current pricing on any Software upgrades, and potential hourly charges for access to OPTIMUS technical support. In addition, Customer shall not be entitled to any refund of pre-paid Subscription Fees in the event that Customer cancels the Subscription Services. For purposes of clarity, subject to Section 6 of the Agreement, OPTIMUS shall continue to be entitled to collect and use Customer’s performance data, even if Customer fails to maintain the Subscription Services.

2.4. **Renewing Subscription Services After Cancellation.** If a Customer cancels their Subscription Services pursuant to these PDST, and later decides to renew the Subscription Services, Customer will be obligated to pay prior to the start of the Renewal Term, (i) prorated Annual Subscription Fees for any time Customer was without coverage, as well as (ii) the Annual Subscription Fee for that Renewal Term. This provides Customer with access to any available historical Performance Data from the covered vehicles, and any OPTIMUS Software upgrades that were missed. Renewal of the Subscription Services after a lapse will not reinstate the Vector System Warranty or the Covered Parts Warranty. Reinstatement of this coverage will be at OPTIMUS’ sole discretion. Any costs for OPTIMUS to reinstate the Vector System Warranty or the Covered Parts Warranty will be the responsibility of the Customer.

3. Additional Termination Rights.

3.1. **Termination for Breach.** In the event of a material breach of these PDST by a party, the other party may terminate this these PDST by giving fourteen (14) days prior, written notice to the breaching party; provided, however, that these PDST shall not terminate if the breaching party has cured the breach before the expiration of such fourteen (14) day period. In addition, in the event Customer fails to pay any Annual Subscription Fee in full when due, OPTIMUS may, at any time and without notice, suspend Customer's access to the Subscription Services and as a result, the Performance Data.

3.2. **Effect of Termination.** Upon termination of these PDST, (a) all rights granted hereunder to Customer shall immediately cease, and OPTIMUS shall immediately suspend Customer's access to the Subscription Services and as a result, the Performance Data; provided, however, that Customer may retain any Performance Data copied, transcribed, or downloaded prior to the termination date.

3.3. **Survival.** The following provisions shall survive termination of these PDST: Section 1.1 ("License"), Section 1.2 ("Compliance with Laws"), Section 1.4 ("Ownership"), Section 2.4 ("Renewing Subscription Services After Cancellation"), Section 3.2 ("Effect of Termination"), Section 4 ("Disclaimer"), Section 5 ("Limitation of Liability"), Section 6 ("Acknowledgement of OPTIMUS' Use of Performance Data as it Relates to Customer's Vehicle"), and this Section 3.3 ("Survival").

4. **Disclaimer.** THE PERFORMANCE DATA IS PROVIDED "AS IS" AND "AS AVAILABLE," AND OPTIMUS MAKES NO WARRANTY WITH RESPECT TO THE PERFORMANCE DATA OR OTHERWISE IN CONNECTION WITH THESE PDST AND HEREBY DISCLAIMS ANY AND ALL EXPRESS, IMPLIED, OR STATUTORY WARRANTIES, INCLUDING, WITHOUT LIMITATION, ANY WARRANTIES OF TITLE, MERCHANTABILITY, NON-INFRINGEMENT, FITNESS FOR A PARTICULAR PURPOSE, AVAILABILITY, ERROR-FREE OR UNINTERRUPTED OPERATION AND ANY WARRANTIES ARISING FROM A COURSE OF DEALING, COURSE OF PERFORMANCE, OR USAGE OF TRADE TO THE EXTENT THAT OPTIMUS MAY NOT AS A MATTER OF APPLICABLE LAW DISCLAIM ANY WARRANTY, THE SCOPE AND DURATION OF SUCH WARRANTY SHALL BE THE MINIMUM PERMITTED UNDER SUCH LAW.

5. **Limitation of Liability.** EXCEPT IN THE EVENT OF A PARTY'S GROSS NEGLIGENCE OR WILLFUL MISCONDUCT, IN NO EVENT SHALL EITHER PARTY BE LIABLE TO EACH OTHER FOR ANY INCIDENTAL, INDIRECT, CONSEQUENTIAL, SPECIAL, EXEMPLARY, OR PUNITIVE DAMAGES OF ANY KIND (INCLUDING, BUT NOT LIMITED TO, LOST REVENUES OR PROFITS) ARISING FROM OR RELATING TO THESE PDST, REGARDLESS OF WHETHER THE APPLICABLE PARTY WAS ADVISED, HAD OTHER REASON TO KNOW, OR IN FACT KNEW OF THE POSSIBILITY THEREOF. EACH PARTY'S AGGREGATE LIABILITY FOR DIRECT DAMAGES UNDER THESE PDST SHALL NOT EXCEED THE FEES PAID BY CUSTOMER UNDER THE CUSTOMER AGREEMENT DURING THE PERIOD TWELVE (12) MONTHS PRIOR TO THE EVENT GIVING RISE TO THE CLAIM.

6. Acknowledgement of OPTIMUS' Use of Performance Data as it Relates to Customer's Vehicle.

CUSTOMER HEREBY ACKNOWLEDGES THAT THE GOODS CONTAIN SOFTWARE THAT COLLECTS PERFORMANCE DATA ON CUSTOMER'S VEHICLE. OPTIMUS COLLECTS AND/OR STORES INFORMATION ABOUT CUSTOMER'S VEHICLE, INCLUDING MILEAGE, FUEL CONSUMPTION, SYSTEM PERFORMANCE, SYSTEM DIAGNOSTICS, TECHNICAL DATA FOR USE IN TROUBLESHOOTING, GPS-TRACKING, REFUELING DATES AND TIMES, AND QUANTITY AND FUEL TYPE DISPENSED. THE SOFTWARE HAS THE ABILITY TO TRANSMIT INFORMATION TO A CENTRAL COMMUNICATIONS SYSTEM OR EXTERNAL DEVICE. CUSTOMER EXPRESSLY CONSENTS TO OPTIMUS' ACCESS TO THE GOODS AND SOFTWARE AND THE INFORMATION SUCH GOODS AND SOFTWARE CAPTURE AND TRANSMIT. CUSTOMER EXPRESSLY CONSENTS TO OPTIMUS' COLLECTION OF PERFORMANCE DATA FROM CUSTOMER'S VEHICLE. ADDITIONALLY, CUSTOMER ACKNOWLEDGES THAT IT SHALL FULFILL THE PURPOSE OF THE SUBSCRIPTION SERVICES FOR OPTIMUS TO ACCESS AND USE PERFORMANCE DATA IN ORDER TO: UNDERSTAND ALL ASPECTS OF THE USE AND OPERATION OF CUSTOMER'S VEHICLE, HELP FACILITATE MAINTENANCE AND REPAIRS TO CUSTOMER'S VEHICLE, COLLECT AND SHARE EMISSIONS DATA, AGGREGATE AND EXAMINE ALL COLLECTED INFORMATION WITH LIKE INFORMATION FROM OTHER CUSTOMERS, MAKE REPORTS TO REGULATORY AUTHORITIES, IF APPLICABLE, BASED ON COLLECTED INFORMATION, AND MONITOR AND OPTIMIZE CUSTOMER'S ORIGINAL VEHICLE MAINTENANCE AND SERVICE.



Proposal for City of Ames – Fleet Department

Carbon Emissions Reduction B100 Pilot Project Combating Climate Change

Rich Iverson, Fleet Support Manager, City of Ames

Dave Slade, Executive Director, Biofuel Technology
& Services

Brian Wierson, Biodiesel Sales & Marketing
Representative, Renewable Energy Group



RENEWABLE ENERGY GROUP

What is the B100 Pilot Project ?

- Reducing Carbon Emissions by using alternate fuel B100
- Five diesel trucks will be equipped to use B100 year-round
- B100 reduces Carbon Intensity by 85% vs. petroleum diesel
- Saving 111 metric tons of carbon emissions per year
- About the same as not burning 100,000 lbs. of coal per year
- Run project for 3 years - evaluate results and report



REG/Optimus Proposal City of Ames

- REG paying all costs associated with City of Ames pilot.
- Including cost to equip 5 vehicles.
- Including cost of storage tank and fuel dispenser.
- City to enter fuel supply agreement with REG to purchase biodiesel.



B100 Pilot Project Vehicles

- City staff selected 5 snow plow trucks for the B100 Project
- REG will pay to equip the 5 trucks for year-round B100 use
- The Optimus System will cost REG \$12,000 for each truck
- The City's 5 trucks to be equipped by end of 2019



Vehicle Selection



2014 7300 International



2018 International 7500 Cummins



2017 International Work Star



2018 International 7500 Cummins



2017 International Work Star



Benefits to City of Ames

- Position Ames as Sustainability Leader
- Reduce Emissions
- Cost Savings
- Data Generation



Making Ames a Sustainability Leader

- Taking action to combat climate change
- Setting examples for sustainable future
- Supporting EcoSmart Goals
- First City in Iowa to utilize this technology with biodiesel



Optimus Technology

- Conversion system that allows diesel vehicles to operate on 100% biodiesel 24/7/365
- Vehicle operates on diesel fuel until tank warms up
- Vehicle switches to operating on 100% biodiesel
- >90% of fuel consumed is biodiesel

SYSTEM OVERVIEW

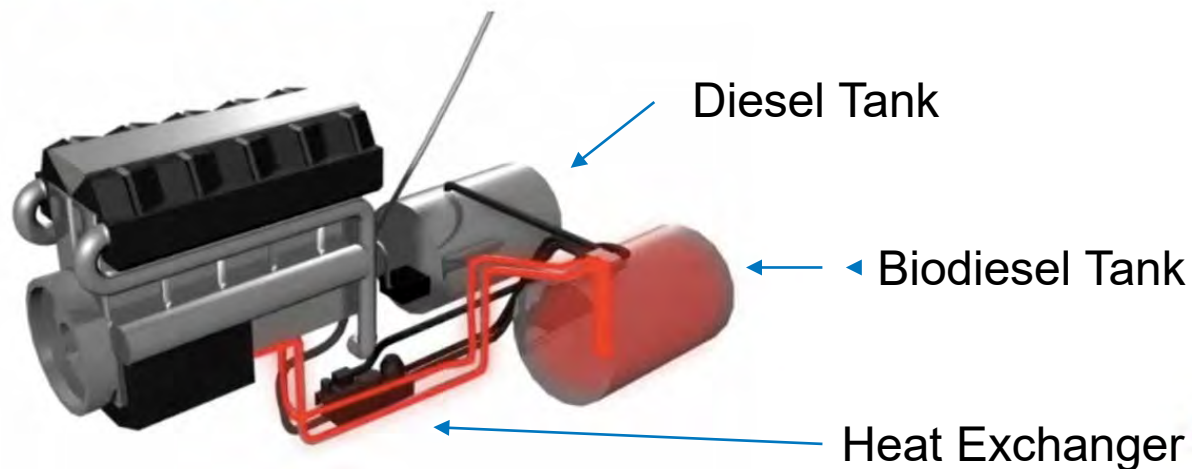

Who else is utilizing technology?

- Washington DC Department of Public Works
- City of Chicago Parks District
- City of Pittsburgh
- Renewable Energy Group



Thank you.

Questions?

Jon Scharingson
Executive Director, Sales & Marketing
Email: jon.Scharingson@regi.com

Rich Iverson
Fleet Support Manger
Email: riverson@city.ames.ia.us



Appendix

Optimus Technology

SYSTEM OVERVIEW

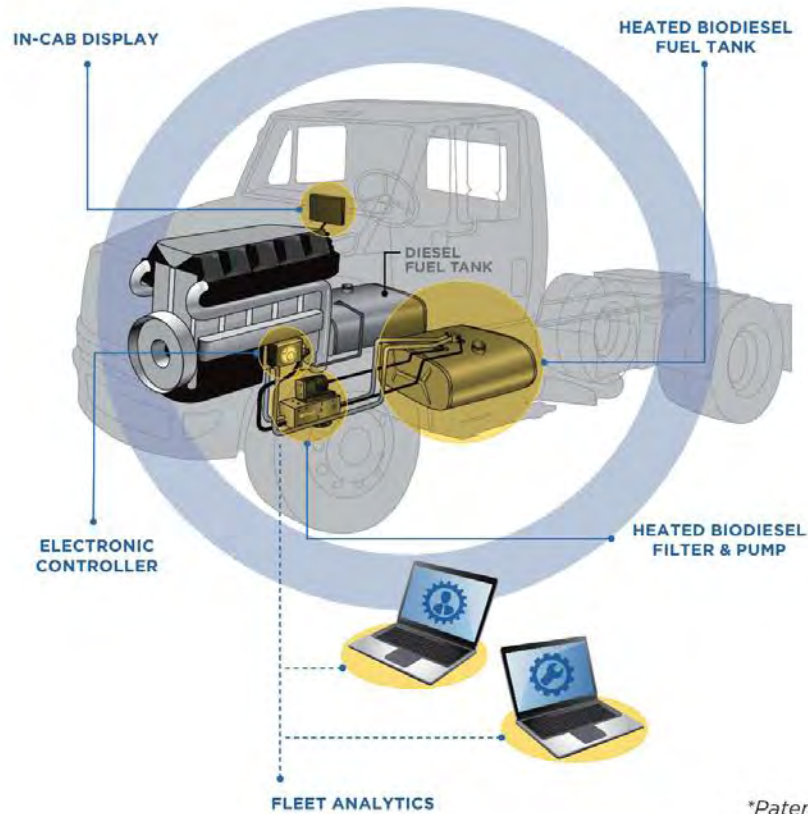

**Patented*



Project Impact (25,000 gallons fuel)

➤ Emissions Reduction

- 264.267 Metric Tonnes of CO2 not released into atmosphere
- Equivalent to 56 passenger vehicles removed from road.

➤ Fuel Savings

- \$1,250 annual savings

➤ Data Generation

- Shared with other entities
- Case study

➤ Leadership

- Press release/case study

Broader adoption will lead to larger impact.



Seeking Approval

- Approval by Ames City Council to modify 5 existing diesel vehicles with technology that will allow them to operate on 100% biodiesel year round.
- Renewable Energy Group (REG) will pay all of the costs to convert the vehicles.
- REG will also pay for and install a dedicated neat biodiesel tank and dispenser at AMES DPW facility that will allow the modified vehicles to fill with biodiesel.
- City of Ames will enter into an exclusive fuel supply contract with REG to supply the converted vehicles.



B100 Dispenser & Tank Filling Outlet DCDPW

Dispenser Hose
Located
Inside Cabinet



Truck Offloading
Tank Inlet



Telemetry and Data

TELEMATICS PORTAL

Vehicle: **Truck 1234**

Template:	Fleet Template	[Remove]
VIN:		
Last Update Check:	4/11/2019 3:37 PM	
Status:	Active	
Data Plan:	Low (500 KB/month)	
Service Plan:	Gold	

TCM Details:

IMEI:	358539072428001
TCM S/N:	90104017813
Report Identifier:	35853907242800

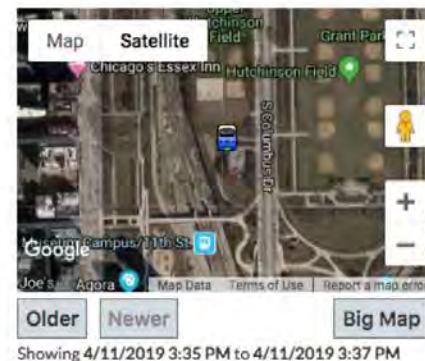

Engineering Data	Updates	Latest	Active Faults
Report Data:			
First record:		2/5/2019 7:21 AM	
Last record:		4/11/2019 3:37 PM	
04/04/2019 to 04/11/2019		Download	
<input checked="" type="radio"/> CSV			
<input type="radio"/> Include GPS			
<input type="radio"/> KMZ (Google Earth)			
Configure Data Logging			

[Dashboard](#) |

| [TCM Index](#) | [Vehicle index](#)



District of Columbia Department of Public Works (DCDPW) 2500 Gallon Tank/Dispenser



2500 Gallon Tank

Fuel Dispenser

Fuel Hose in Cabinet

Truck Offloading Tank Inlet



Dimensions Tank/Dispenser for City of Ames

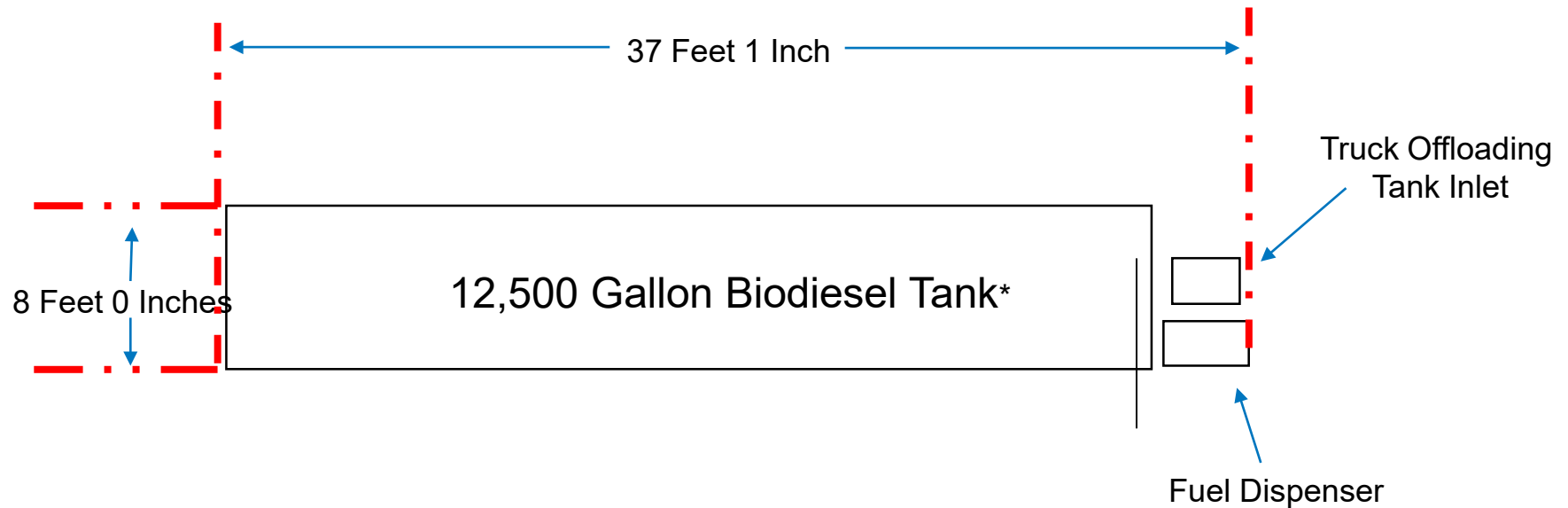

*Note tank for Ames is 5 times larger than DCDPW 2500 gallon tank.



Tank Description/Regulatory Requirements

- 12,500 gallon tank to allow full transport deliveries
- Dual wall tanks with 110% spill containment volume
- Flameshield registered
- Product will be minimum 99.9% biodiesel and considered non-hazmat



Principals Involved

➤ Renewable Energy Group

- Nation's largest producer and marketer of biomass based diesel fuel.
- 10 operating biorefineries in the United States.
- \$2.4 billion in revenue in 2018
- Global Corporate HQ: Ames, Iowa
- Publicly listed on NASDAQ: REGI

➤ Optimus Technologies

- Developed patented proprietary system that allows any existing diesel engine to operate on 100% biodiesel.
- Company formed in 2010.
- 2018 Optimus and REG entered into a strategic agreement to jointly market Optimus technology to fleets in key markets.



COUNCIL ACTION FORM

SUBJECT: PRELIMINARY PLAT FOR IOWA STATE UNIVERSITY RESEARCH PARK PHASE 4, 1st ADDITION

BACKGROUND:

The majority of the area subject to the proposed preliminary plat was included as an outlot with the preliminary plat for Iowa State University Research Park (ISURP), Phase 3 approved by the City Council on July 1, 2015. A location map is found in Attachment A. The first preliminary plat was based upon a master plan for Phase 3 that included 23 developable lots and three outlots for storm water management. Since the approval of the preliminary plat for Phase 3, two final plats have been approved establishing 7 lots for development, an outlot for the Tedesco Environmental Learning Corridor, and outlots for future development and storm water management. The most recent approval was for a major amendment to the Plat to create the 3rd Addition for the John Deere building site in 2018.

This proposed preliminary plat creates six lots and one outlot for future development (Outlot W). The construction of Collaboration Place and improvements to South Riverside are already underway by the City in conjunction with a development agreement with ISURP. This Preliminary Plat expands the area originally included within the master plan and preliminary plat boundaries of Phase 3 to absorb the former “Riley” Farm on the west side of South Riverside Drive, north of Collaboration Place and requires dedication of right-of-way as Lot A and Lot B. The project includes an updated Master Plan to guide future subdivision and improvements for the area, including utilities, trails, and open space. The Phase 4 area includes a trail connection from Collaboration Place to the Ted Tedesco Environmental Learning Corridor. The trail connections planned for the area provide amenities for the area and are related to the original street length waiver for Collaboration Place to exceed 1,320 feet of length without other intersections. The trail within Phase 4 is planned to be completed with development of the lots.

Utilities (water and sewer) along Collaboration Place were put in with a previous phase of development. An extension of water and sanitary sewer will occur south of Collaboration Place, adjacent to the existing developed lot at 3525 South Riverside Drive (John Deere). A shared use path will run along the west side of South Riverside Drive. Collaboration Place will include bike lanes on the street and sidewalks along the frontage. The sidewalk improvements are the responsibility of the developer.

The Planning and Zoning Commission review the project at a public hearing on August 21, 2019. The Planning and Zoning Commission voted (7-0) to recommend that the City Council approve the proposed preliminary plat. The applicant has completed conditions for updating notation on the plans that were part of the Commission recommendation to approve the plat.

ALTERNATIVES:

1. The City Council approve the Preliminary Plat for Iowa State University Research Park Phase 4, 1st Addition as consistent with the rezoning master plan and development standards of Chapter 23 of the Ames Municipal Code.
2. The City Council deny the Preliminary Plat for Iowa State University Research Park Phase 4, 1st Addition, by finding that the Preliminary Plat does not meet the requirements of Section and by setting forth its reasons to disprove or modify the proposed preliminary plat as required by Section 23.302(6)(b) of the Ames Municipal Code.
3. The Planning and Zoning Commission can defer action on this request to the next regular meeting and refer it back to City staff and/or the applicant for additional information.

CITY MANAGER'S RECOMMENDED ACTION:

This preliminary plat proposal includes six developable lots and an outlot south of Collaboration Place for future development. Water and sanitary sewer that will serve the lots have previously been installed. The majority of the remaining public improvements will be completed by the City, the developer will complete other improvements, such as sidewalks, consistent with an existing development agreement.

Therefore, it is the recommendation of the City Manager that the City Council approve Alternative #1 recommending approval of the Preliminary Plat for Iowa State University Research Park Phase 4, 1st Addition to the City Council.

Addendum

General Site Info

This preliminary plat proposal includes six developable lots, one outlot for future development and the dedication of right of way of South Riverside Drive and the extension of Collaboration Place. Improvements including sidewalks, shared use paths, utility extensions, and street paving will be completed as a Capital Improvement project. Utilities to serve individual lots will be installed as final plats are approved and development occurs.

Streets

South Riverside Drive will be improved as a 31' paved section within an 80' right of way, about 1,600 feet from where the paving currently ends. This will extend to the south edge of 3525 South Riverside Drive (John Deere). Collaboration Place will be improved as a 36' paved street in an 80' right of way. The street will include bike lanes.

Water

A public water main currently exists in the corridor of the planned extension of Collaboration Place, although the right-of-way had not been previously established nor that portion of the street paved. A new public water main will be installed in South Riverside Drive from the intersection with Collaboration Place to the south edge of 3525 South Riverside Drive (John Deere).

Sewer

A public sanitary sewer line currently exists between the north side of Collaboration Place and the north boundary of the plat where it ties into the existing system. A new section of sanitary sewer, approximately 300' long, will be installed as part of the improvements to South Riverside Drive on the north side of 3525 South Riverside Drive (John Deere).

Sidewalks and Trails

A shared-use path will be installed along the west side of South Riverside Drive as part of the road improvements. Sidewalks will be constructed along Collaboration Place. Additionally, the developer will be responsible for a trail connection to be installed in order to provide a connection between the Ted Tedesco Environment Living Corridor and development to the south.

Storm Water Management

The overall area is served by a number of regional storm water facilities to the north and south. Storm water facilities will be directed to the detention pond between Collaboration Place and 3525 South Riverside Drive (John Deere).

ATTACHMENT A: LOCATION MAP

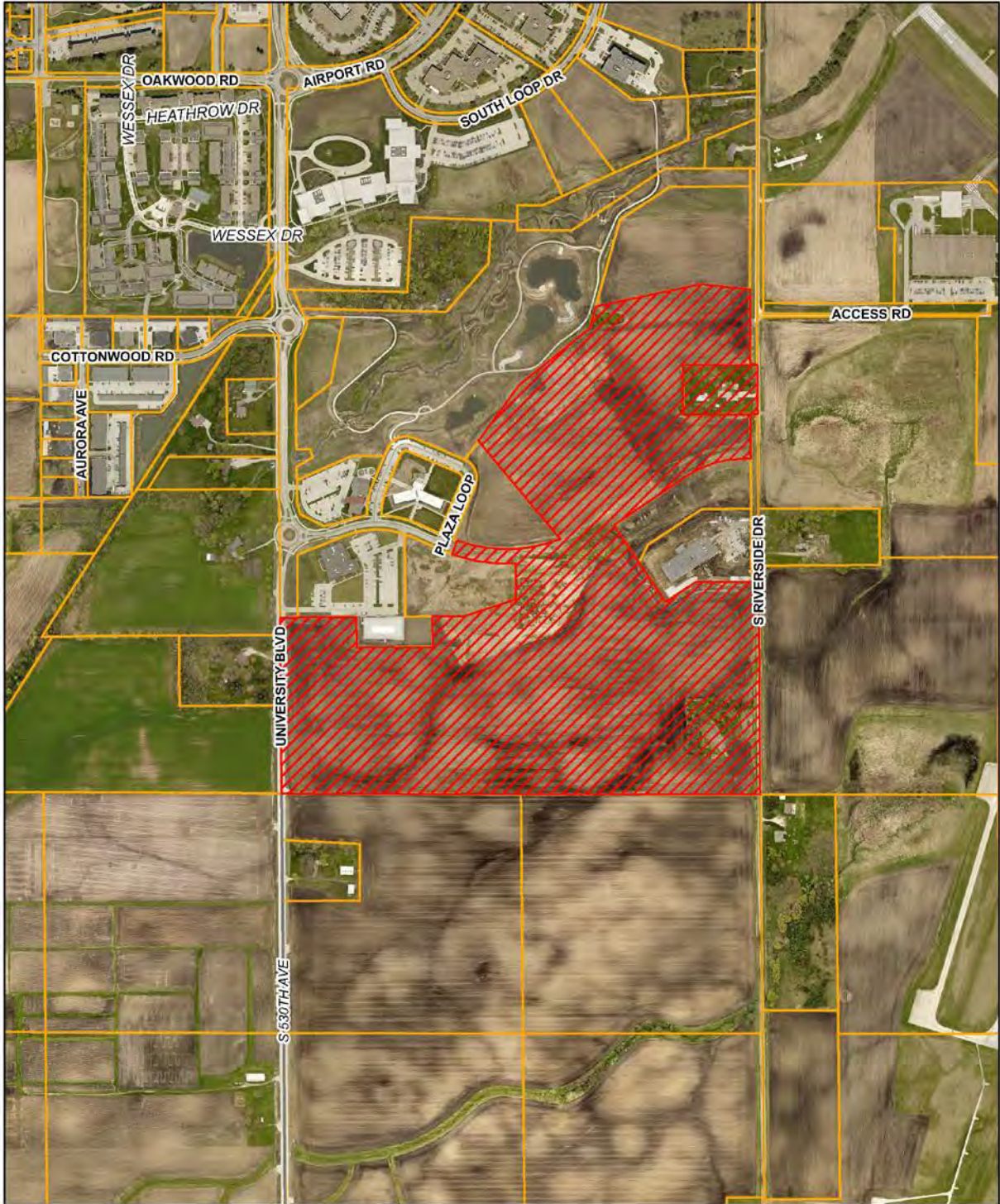

**Preliminary Plat of Iowa State University Research Park
Phase Four - 1st Addition**

ATTACHMENT B: PROPOSED MASTER PLAN LOT LAYOUT (INFORMATIONAL)

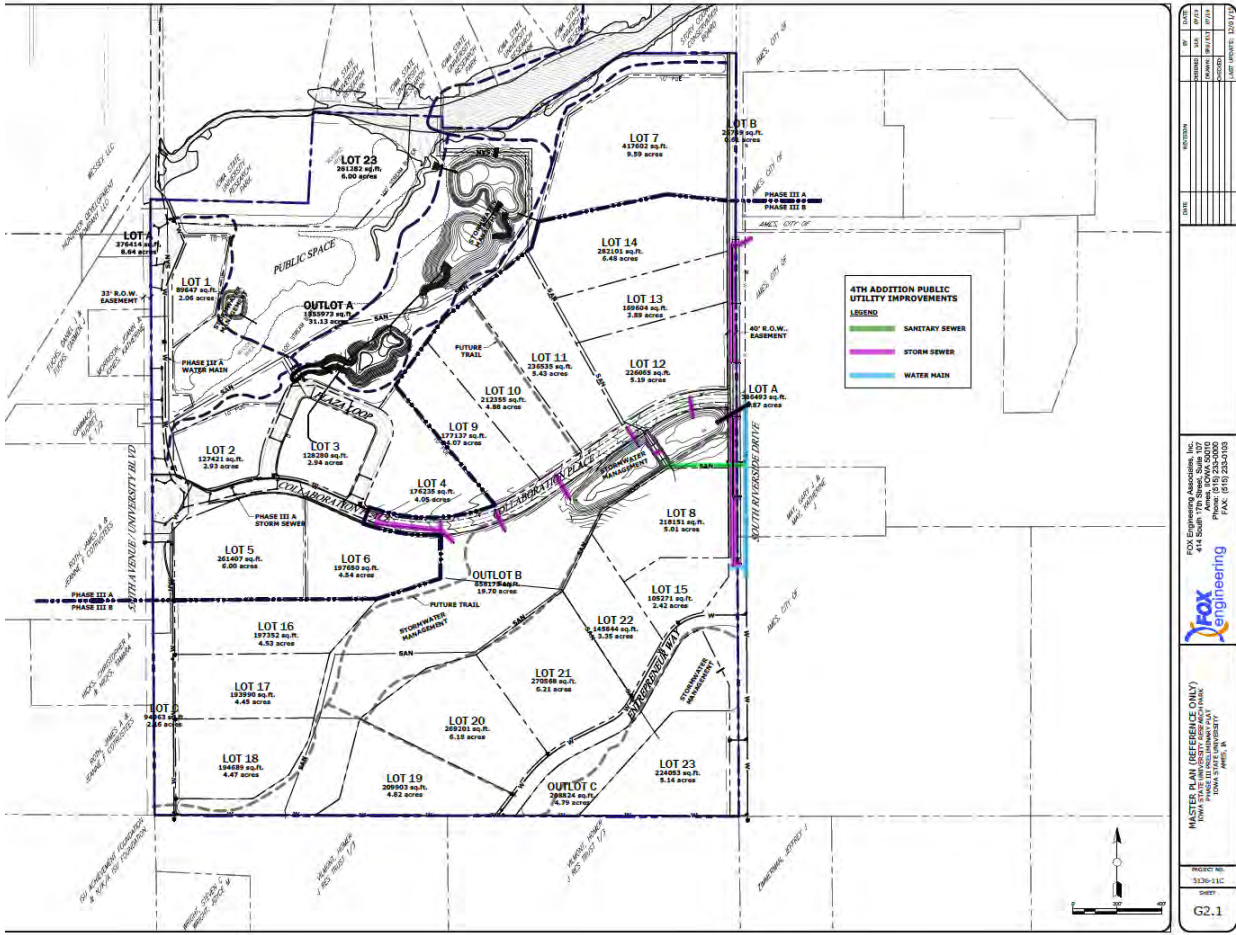

ATTACHMENT C: PROPOSED PRELIMINARY PLAT

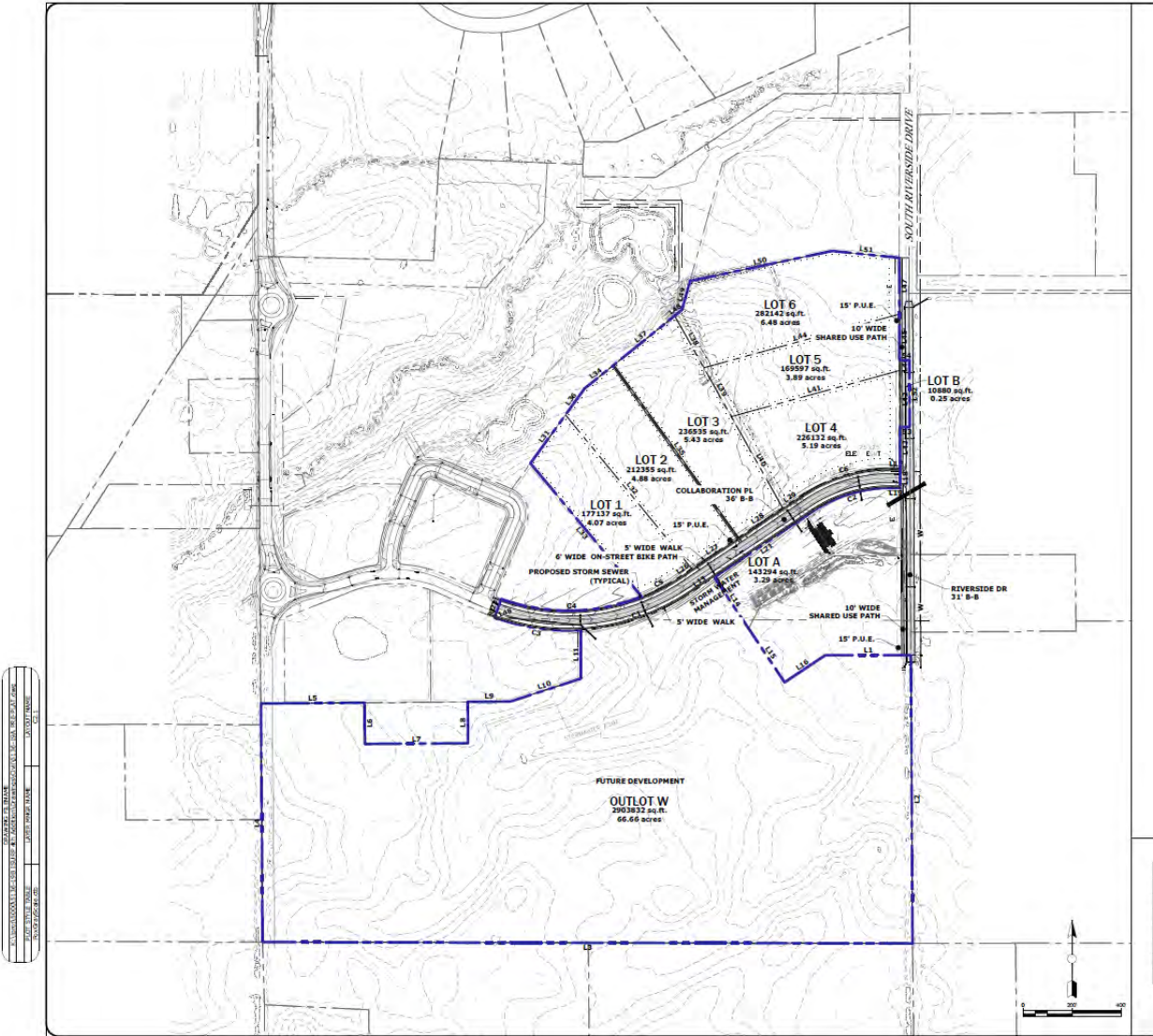

ATTACHMENT D: APPLICABLE SUBDIVISION LAW

The laws applicable to this Preliminary Plat Subdivision include, but are not limited to, the following: (verbatim language is shown in *italics*, other references are paraphrased):

Code of Iowa Chapter 354, Section 8 requires that the governing body shall determine whether the subdivision conforms to its Land Use Policy Plan.

Ames Municipal Code Chapter 23, Subdivisions, Division I, outlines the general provisions for subdivisions within the City limits and within two miles of the City limits of Ames.

Ames Municipal Code Section 23.302(6):

(6) *City Council Action on Preliminary Plat:*

- (a) *Based upon such examination, the City Council shall determine whether the Preliminary Plat conforms to relevant and applicable design and improvement standards in these Regulations, to other City ordinances and standards, to the City's Land Use Policy and to the City's other duly adopted plans. In particular, the City Council shall determine whether the subdivision conforms to minimum levels of service standards set forth in the Land Use Policy Plan for public infrastructure and shall give due consideration to the possible burden of the proposed subdivision on public improvements in determining whether to require the installation of additional public improvements as a condition of approval.*
- (b) *Following such examination and within 30 days of the referral of the Preliminary Plat and report of recommendations to the City Council by the Planning and Zoning Commission, the City Council shall approve, approve subject to conditions, or disapprove the Preliminary Plat. The City Council shall set forth its reasons for disapproving any Preliminary Plat or for conditioning its approval of any Preliminary Plat in its official records and shall provide a written copy of such reasons to the developer.*

IOWA STATE UNIVERSITY RESEARCH PARK

IOWA STATE UNIVERSITY RESEARCH PARK

PRELIMINARY PLAT

PHASE FOUR - 1ST ADDITION
IOWA STATE UNIVERSITY
AMES, IOWA

LOCATION MAP

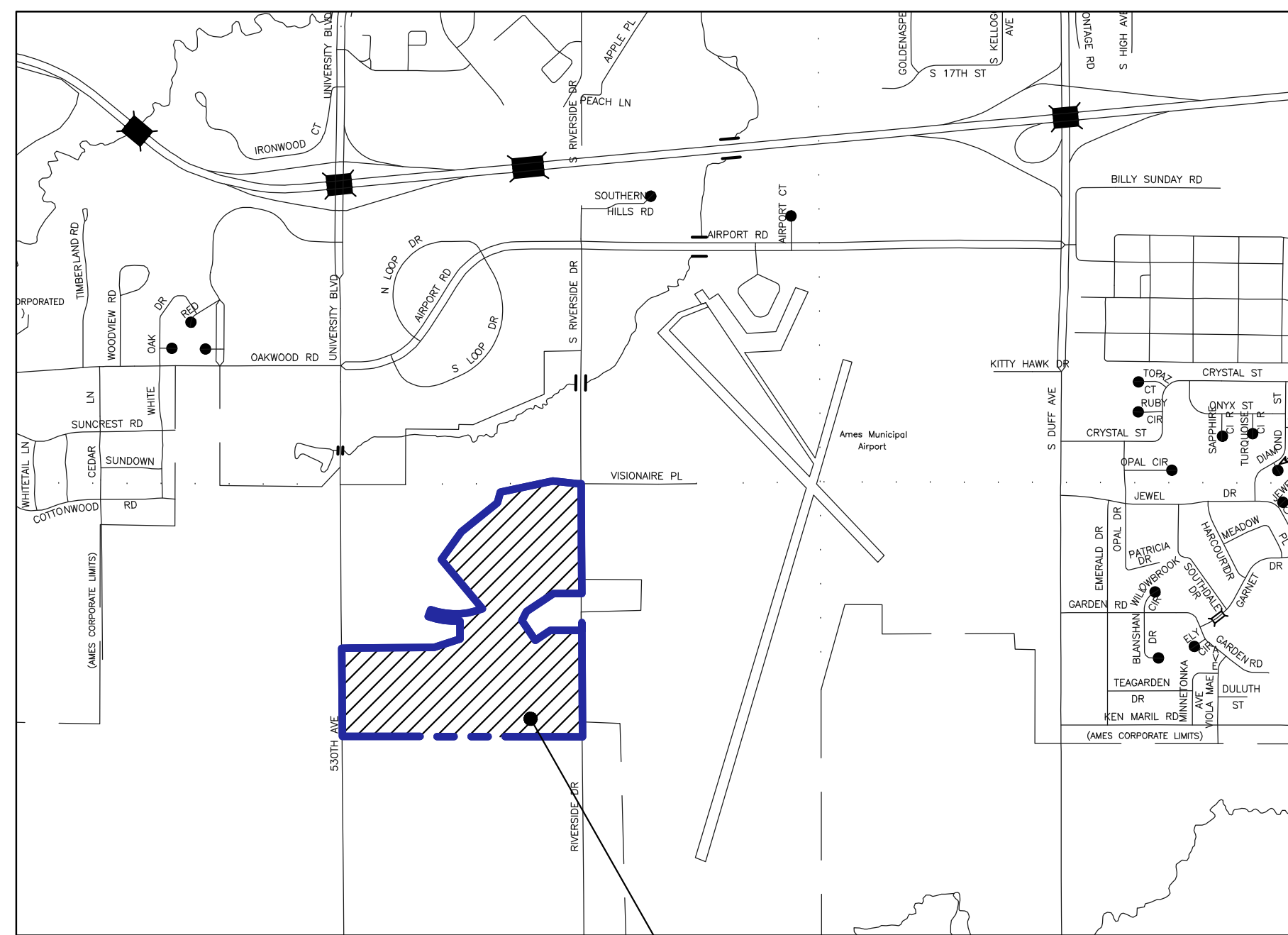

PROJECT LOCATION

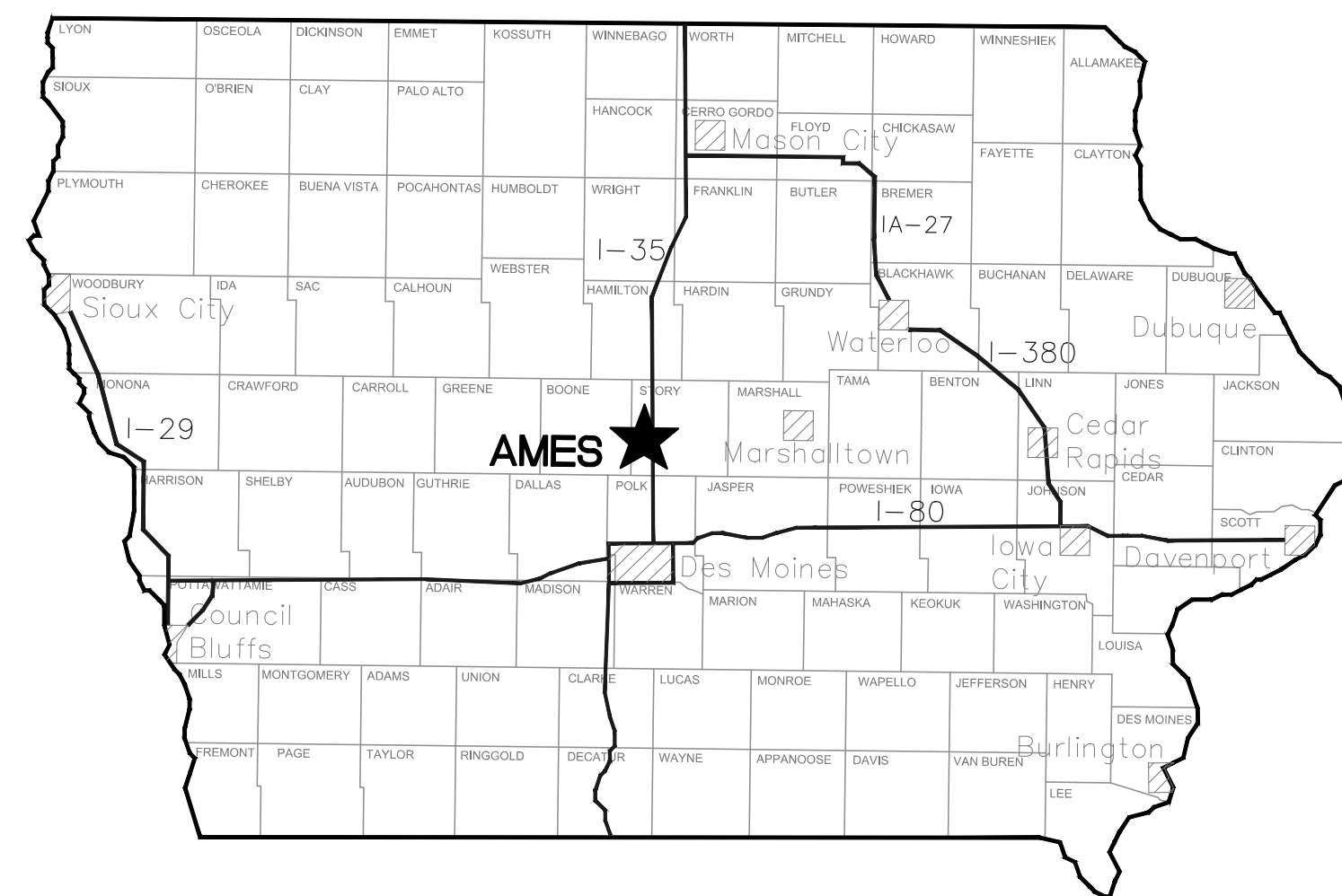

GENERAL NOTE: ALL UTILITIES ARE ONLY GENERALLY LOCATED. CONTRACTOR IS RESPONSIBLE FOR LOCATING AND EXPOSING ALL UTILITIES THAT MAY INTERFERE WITH CONSTRUCTION BEFORE CONSTRUCTION BEGINS.

INDEX OF SHEETS	
No.	Description
G1.1	COVER SHEET/ LOCATION MAP/LEGEND
G2.1	MASTER PLAN (REFERENCE ONLY)
C1.1	EXISTING CONDITIONS
C2.1	PHASE IV 1ST ADDITION PRELIMINARY PLAT (OVERALL)
C2.2	PHASE IV 1ST ADDITION PRELIMINARY PLAT (NORTH)
C2.3	PHASE IV 1ST ADDITION PRELIMINARY PLAT (SOUTH)

OWNER
Iowa State University Research Park Corp.
1805 Collaboration Place
Suite 1250
Ames, IA 50010

DEVELOPER
ISU Research Park Corporation
2712 South Loop Drive
Suite 4050
Ames, IOWA 50010

PLAN PREPARER/ENGINEER
Eric Thompson, P.E.
FOX Engineering Associates
414 S. 17th Street, Suite 107
Ames, IOWA 50010

LEGAL DESCRIPTION
Outlot X, except Parcel A therein, in Iowa State University Research Park Phase III, Third Addition; And, beginning at a point on the east line of the NW1/4 of Sec. 22-83-24, which is 241.45 feet South of the N1/4 Corner thereof; thence S89°55'30"W, 412.0 feet; thence South 272.0 feet; thence N89°55'30"E, 412.0 feet to the east line of said NW1/4; thence North 272.0 feet along said line to the point of beginning, all in the City of Ames, Story County, Iowa, and all together containing 100.12 acres which includes 2.21 acres of public right of way

ZONING
Existing: Research Park Innovation District
Proposed: No changes are proposed.

UTILITIES
All private utilities will be located within public utility easements shown, or within utility corridors provided for by the City's "Use of City Rights-of-Way Users" ordinance.

All sanitary sewer mains will be 12" or 8" diameter.

All water mains will be 12" diameter as shown.

SIDEWALKS, SHARED-USE PATHS, AND BICYCLE FACILITIES
5' wide sidewalks will be constructed along public streets, where shown.

10' wide paved shared-use paths will be constructed, where shown.

6' wide on-street bike lane will be constructed on collaboration where shown.

STREETS
Collaboration Place will be 36' wide within 80' wide right-of-way.

Riverside Dr will be 31' wide within 80' wide right of way

Lot A will be dedicated to the City of Ames as Right of Way

Lot B will be dedicated to the City of Ames as Right of Way

PARKING RESTRICTIONS
Vehicle parking will be prohibited as follows:
Collaboration Place - no parking
Riverside Drive - no parking

SEDIMENT AND EROSION CONTROL
This site will be covered by an IOWA Department of Natural Resources NPDES permit. A sediment and erosion control plan will be created, and NPDES and City of Ames COSECO permits will be obtained before grading activities for each addition within the subdivision begin.

ENGINEER:
FOX ENGINEERING
414 SOUTH 17TH STREET, SUITE 107
AMES, IOWA 50010
PHONE: (515) 233-0000
FAX: (515) 233-0103



LEGEND	
PROPOSED	EXISTING
[Symbol] Concrete Paving	[Symbol] Beehive Intake
[Symbol] Sidewalk	[Symbol] Bollard
[Symbol] Cleanout	[Symbol] Building
	[Symbol] Buried Power
	[Symbol] Bushes
	[Symbol] Cable Pedestal
	[Symbol] Cleanout
	[Symbol] Culvert
	[Symbol] Curb Stop
	[Symbol] Electric Pedestal
	[Symbol] Fence
	[Symbol] FO Fiber Optic
	[Symbol] FM Force Main
	[Symbol] G Gas Line
	[Symbol] Gas Meter
	[Symbol] Gas Valve
	[Symbol] Hydrant
	[Symbol] Electric Junction Box
	[Symbol] Light Post
	[Symbol] Mailbox
	[Symbol] Manhole
	[Symbol] Overhead Communication
	[Symbol] Overhead Power
	[Symbol] Power Pole
	[Symbol] Property Pin
	[Symbol] Property/Right-Of-Way Line
	[Symbol] Railroad Tracks
[Symbol] SAN Sanitary Manhole	[Symbol] SAN Sanitary Manhole
[Symbol] SAN Sanitary Sewer	[Symbol] SAN Sanitary Sewer
[Symbol] Storm Intakes	[Symbol] Storm Intakes
[Symbol] Storm Sewer	[Symbol] Storm Sewer
[Symbol] Storm Sewer Manhole	[Symbol] Storm Sewer Manhole
[Symbol] SubDrain	[Symbol] Stump
	[Symbol] Buried Communication
	[Symbol] Telephone Manhole
	[Symbol] Telephone Pedestal
	[Symbol] Telephone Pole
	[Symbol] Traffic Pole
	[Symbol] Tree Line
	[Symbol] Trees
[Symbol] W Water Line	[Symbol] W Water Line
[Symbol] Water Valve	[Symbol] Water Manhole
[Symbol] Yard Hydrant	[Symbol] Water Meter
	[Symbol] Water Valve
	[Symbol] Witness Post
	[Symbol] Yard Hydrant

THE STATEWIDE URBAN DESIGN AND SPECIFICATIONS (SUDAS 2018) AND THE IOWA DEPARTMENT OF TRANSPORTATION STANDARD SPECIFICATIONS PLUS GENERAL SUPPLEMENTAL SPECIFICATIONS; AND APPLICABLE SUPPLEMENTAL SPECIFICATIONS, DEVELOPMENTAL SPECIFICATIONS, AND SPECIAL PROVISIONS; AND ALL APPROPRIATE ADDENDUMS AND REVISIONS SHALL APPLY TO THE CONSTRUCTION WORK ON THIS PROJECT UNLESS NOTED ON THE PLANS OR IN THE CONTRACT.

SPECIFICATIONS:
ALL WORK SHALL BE IN ACCORDANCE WITH CURRENT CITY OF AMES STANDARD SPECIFICATIONS COPIES OF WHICH CAN BE OBTAINED FROM THE PUBLIC WORKS DEPARTMENT, 515 CLARK AVENUE.

I hereby certify that this engineering document was prepared by me or under my direct personal supervision and that I am a duly licensed Professional Engineer under the laws of the State of Iowa.

ERIC L. THOMPSON P.E. DATE
License number 21937

My license renewal date is December 31, 2020.

Pages or sheets covered by this seal:

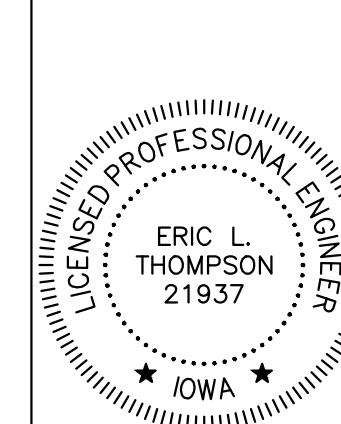

SITE NOTE:
ALL CONSTRUCTION MATERIALS, DUMPSTERS, DETACHED TRAILERS OR SIMILAR ITEMS ARE PROHIBITED ON PUBLIC STREETS OR WITHIN THE PUBLIC RIGHT-OF-WAY.

DRAWING FILENAME: K:\proj\5000\5136-19B-19B-19B-19B-19A PRE-PLAT.dwg
PLOT STYLE TABLE: FoxGray.ctb
LAYER MNGR NAME: G1.1

REVISION	DATE	BY	DESIGNED	ELT	DRAWN	ELT	CHECKED	ELT	LAST UPDATE:
									8/20/19

FOX Engineering Associates, Inc.
414 South 17th Street, Suite 107
Ames, Iowa 50010
Phone: (515) 233-0000
FAX: (515) 233-0103

COVER SHEET/ LOCATION MAP/ LEGEND
IOWA STATE UNIVERSITY RESEARCH PARK
PHASE FOUR - 1ST ADDITION
IOWA STATE UNIVERSITY
AMES, IOWA

PROJECT NO.
5136-19B
SHEET
G1.1

DRAWING FILENAME: K:\V\100\5136-11C\Drawings\Civil\5136-11C-PRE PLAT.dwg
 PLOT STYLE TABLE: FoxGrayScale.ctb
 LAYER MNGR NAME: G2.1
 LAYOUT NAME: G2.1

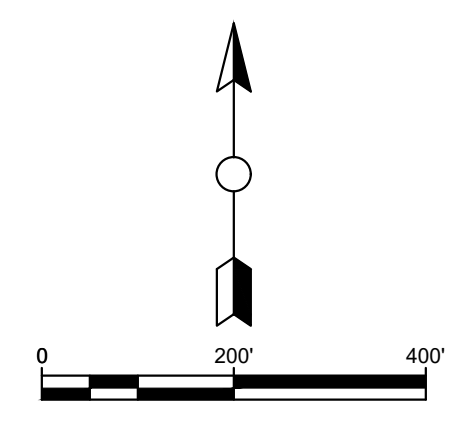
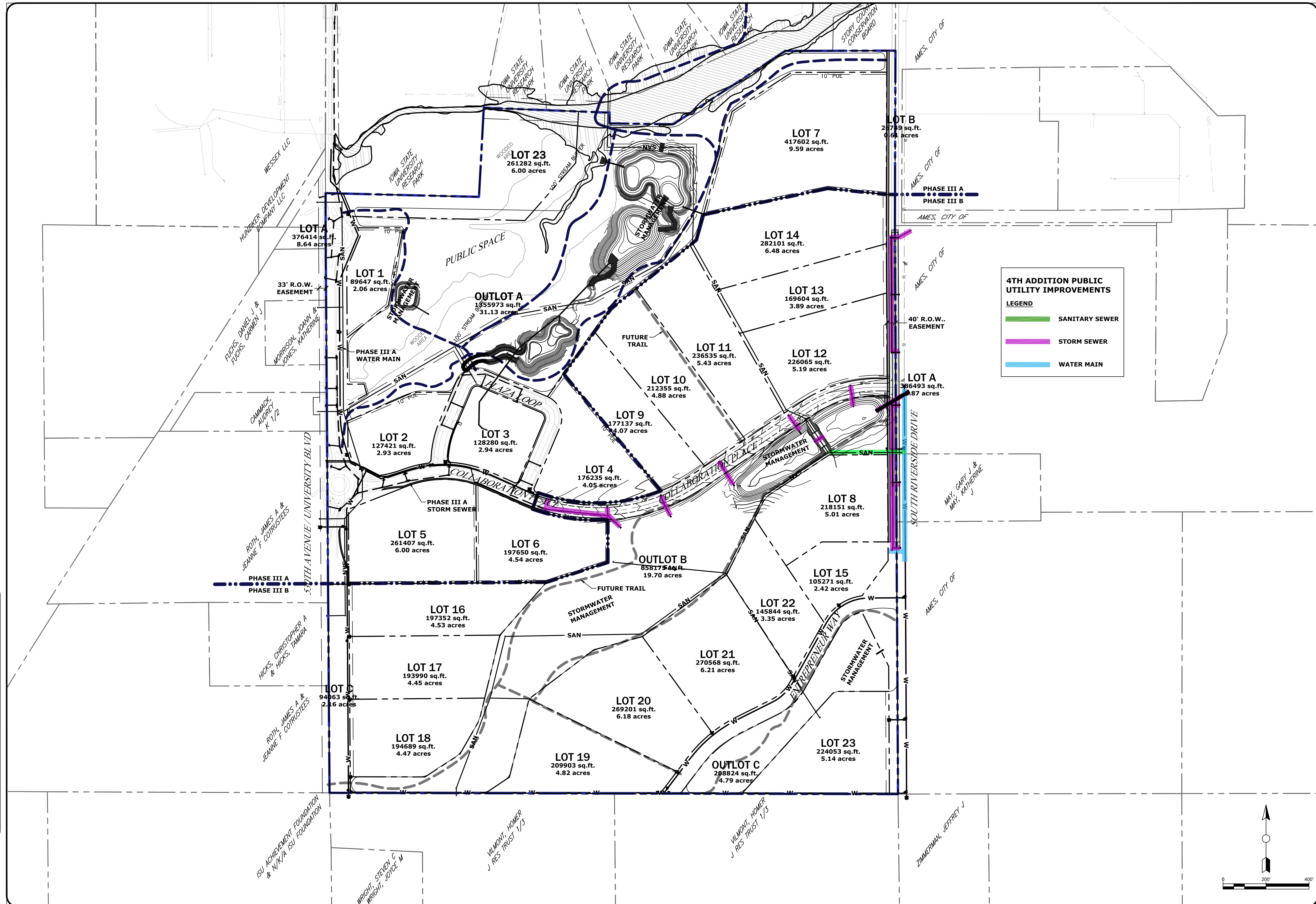

DATE	BY	REVISION
07/19 <td>SJR <td></td> </td>	SJR <td></td>	
07/19 <td>SRS/ELT <td></td> </td>	SRS/ELT <td></td>	
	CHECKED	
	LAST UPDATE:	12/01/15

FOX Engineering Associates, Inc.
 414 South 17th Street, Suite 107
 Ames, Iowa 50010
 Phone: (515) 233-0000
 FAX: (515) 233-0103

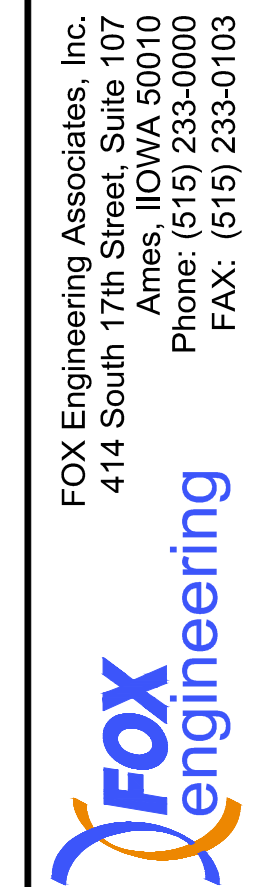

MASTER PLAN (REFERENCE ONLY)
 IOWA STATE UNIVERSITY RESEARCH PARK
 PHASE III PRELIMINARY PLAT
 IOWA STATE UNIVERSITY
 AMES, IA

PROJECT NO. 5136-11C
 SHEET G2.1

DRAWING FILENAME
 K:\[proj]5000\5136-19B ISURP 4th Addition\Drawings\Civil\5136-19A PRE-PLAT.dwg
 PLOT STYLE TABLE
 FoxGrayScale AERIAL.ctb
 LAYER MNGR NAME
 LAYOUT NAME
 CL.1

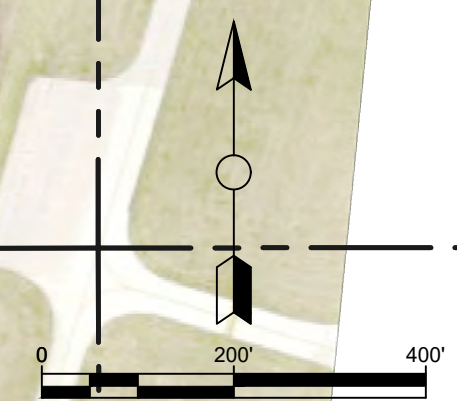
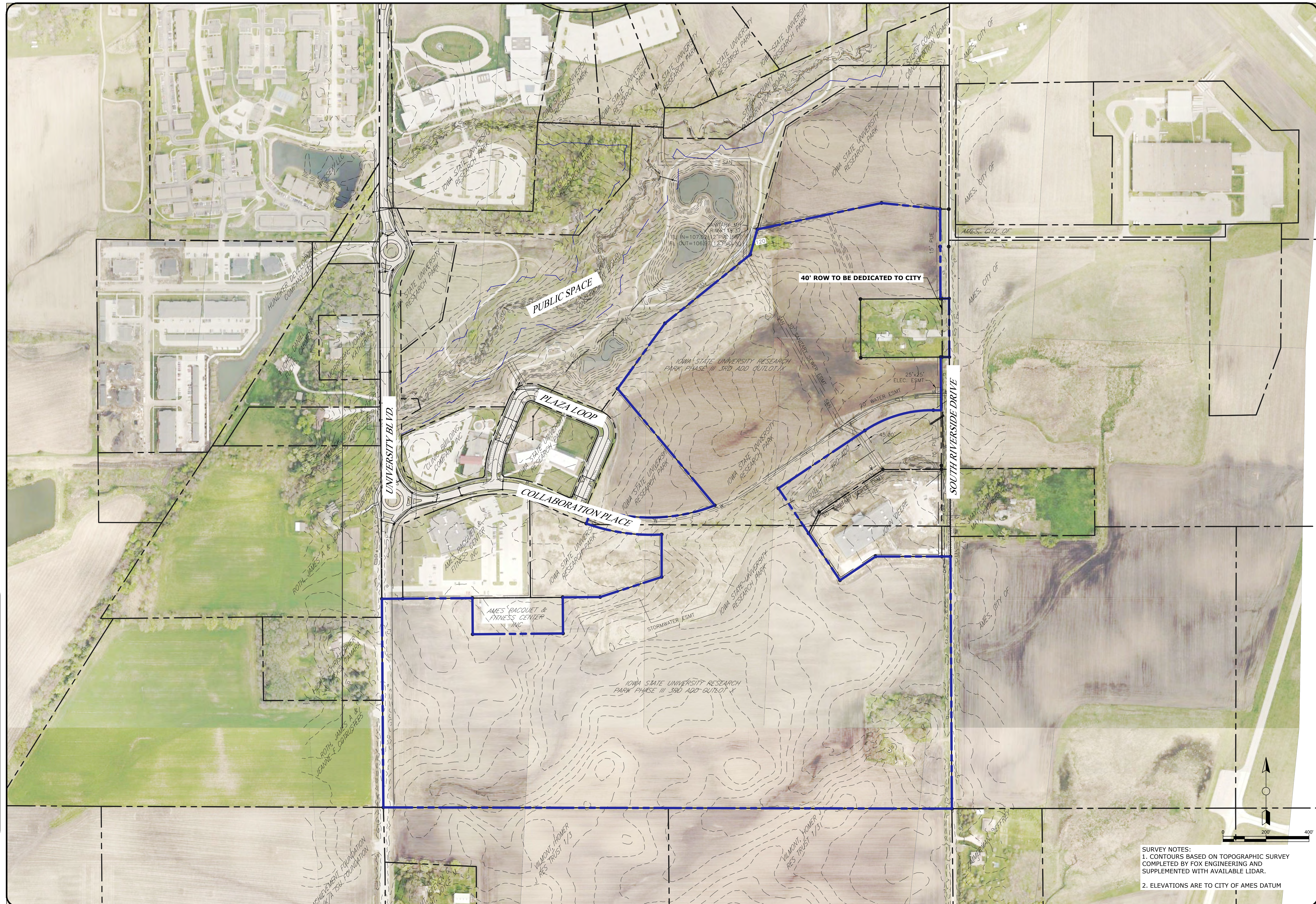

SURVEY NOTES:
 1. CONTOURS BASED ON TOPOGRAPHIC SURVEY COMPLETED BY FOX ENGINEERING AND SUPPLEMENTED WITH AVAILABLE LIDAR.
 2. ELEVATIONS ARE TO CITY OF AMES DATUM

DATE	REVISION	BY	DATE
		DESIGNED: ELT	08/19
		DRAWN: ELT	08/19
		CHECKED:	
		LAST UPDATE:	8/20/19

FOX Engineering Associates, Inc.
 414 South 17th Street, Suite 107
 Ames, Iowa 50010
 Phone: (515) 233-0000
 FAX: (515) 233-0103

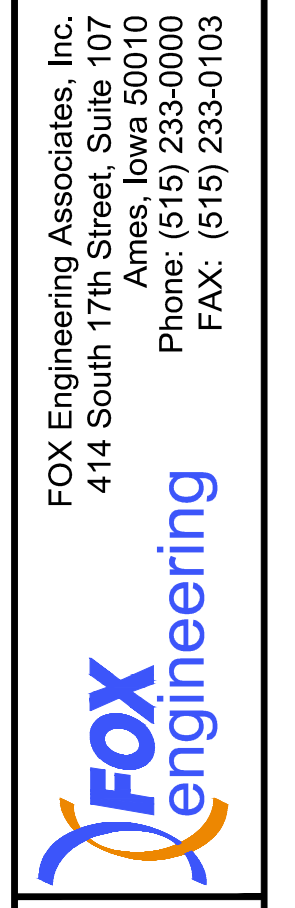

EXISTING CONDITIONS
 IOWA STATE UNIVERSITY RESEARCH PARK
 PHASE FOUR - 1ST ADDITION
 IOWA STATE UNIVERSITY
 AMES, IOWA

PROJECT NO.
 5136-19B
 SHEET
C1.1

DRAWING FILENAME
 K:\PROJ\5000\5136-19B\ISURP 4th Addition\Drawings\Civil\5136-19A PRE-PLAT.dwg
 PLOT STYLE TABLE
 FoxGrayScale.ctb
 LAYER MNGR NAME
 LAYOUT NAME
 C2.1

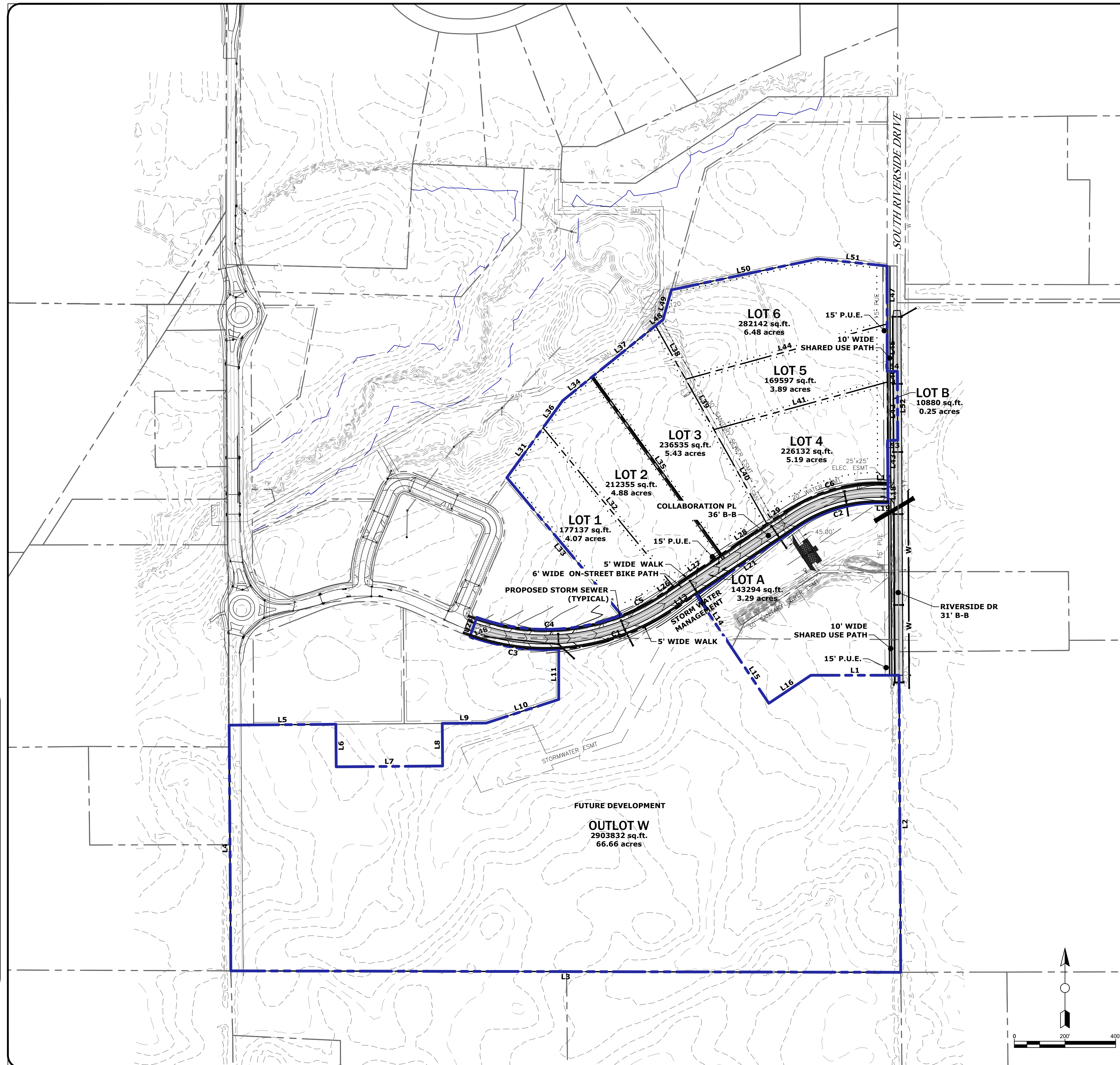

Parcel Line Data		
Line Number	Bearing	Distance
L1	N89°59'52"E	347.98'
L2	S0°19'22"E	1172.51'
L3	N89°52'24"W	2644.20'
L4	N0°24'00"W	969.62'
L5	N89°27'41"E	421.16'
L6	S0°28'21"E	168.44'
L7	N89°31'58"E	420.00'
L8	N0°28'21"W	168.96'
L9	N89°27'41"E	175.06'
L10	N72°05'23"E	299.45'
L11	N0°00'00"E	197.76'
L13	N56°16'49"E	603.77'
L14	S33°49'00"E	252.16'
L15	S33°49'00"E	262.68'
L16	N56°16'49"E	199.46'
L17	S89°17'44"E	34.61'
L18	S0°19'19"E	80.01'
L19	N89°17'44"W	36.05'
L21	S56°16'49"W	484.25'
L23	N19°47'18"E	80.00'
L26	N56°16'49"E	62.56'
L27	N56°16'49"E	225.71'
L28	N56°16'49"E	219.08'
L29	N56°16'49"E	96.42'
L31	N35°54'39"E	375.42'
L32	S39°23'42"E	808.59'
L33	N39°49'19"W	705.95'
L34	N51°07'52"E	509.09'
L35	S35°52'49"E	864.74'
L36	N35°54'39"E	375.42'
L37	N51°07'52"E	509.09'
L38	S29°20'47"E	242.11'
L39	S29°20'47"E	227.99'
L40	S29°20'47"E	425.47'
L41	N74°40'41"E	709.46'
L42	S0°19'19"E	272.02'
L43	S0°19'19"E	167.52'
L44	N74°40'41"E	823.98'
L45	S0°19'19"E	187.09'
L46	S0°19'19"E	272.02'
L47	S0°03'21"W	229.00'
L48	N51°07'52"E	509.09'
L49	N15°31'36"E	122.07'
L50	N78°03'58"E	591.22'
L51	S84°05'51"E	274.12'
L52	S0°19'19"E	272.01'
L53	S89°35'28"W	40.00'
L54	N89°36'11"E	40.00'

Parcel Curve Data			
Curve Number	Length	Radius	Delta
C1	473.12'	890.00'	30°27'30"
C2	336.46'	560.00'	34°25'27"
C3	356.57'	890.00'	22°57'17"
C4	583.51'	810.00'	41°16'29"
C5	171.47'	810.00'	12°07'44"
C6	384.43'	645.00'	34°08'57"

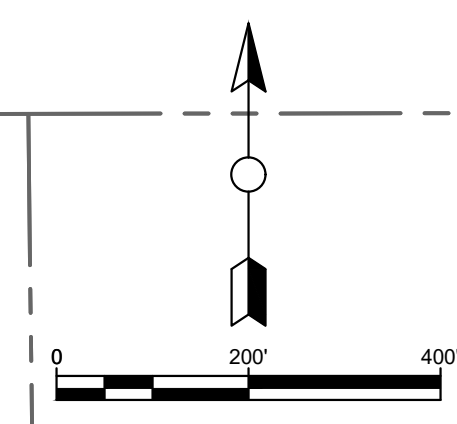

DATE	BY	REVISION
08/19	ELT	DESIGNED
08/19	ELT	DRAWN
		CHECKED
		LAST UPDATE: 8/20/19

FOX Engineering Associates, Inc.
 414 South 17th Street, Suite 107
 Ames, Iowa 50010
 Phone: (515) 233-0000
 FAX: (515) 233-0103

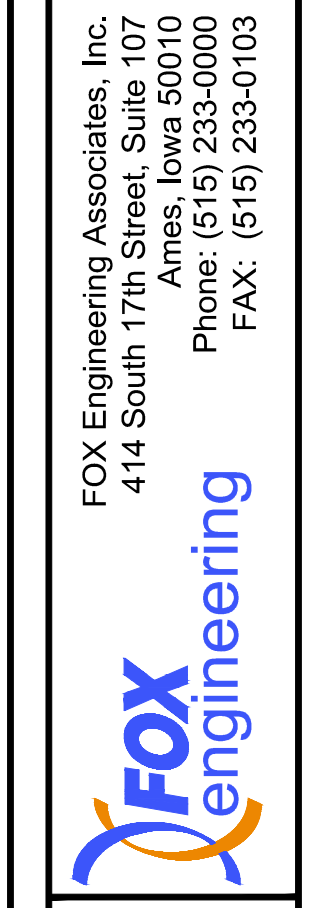

PHASE FOUR - 2ND ADD. PRELIMINARY PLAT (OVERALL)
 IOWA STATE UNIVERSITY RESEARCH PARK
 PHASE FOUR - 1ST ADDITION
 IOWA STATE UNIVERSITY
 AMES, IOWA

PROJECT NO.
 5136-19B
 SHEET
C2.1

DRAWING FILENAME
K:\PROJ\5000\5136-19B\ISURP 4th Addition\Drawings\Civil\5136-19A PRE-PLAT.dwg
PLOT STYLE TABLE
FoxGrayScale.ctb
LAYER MNGR NAME
C2.2

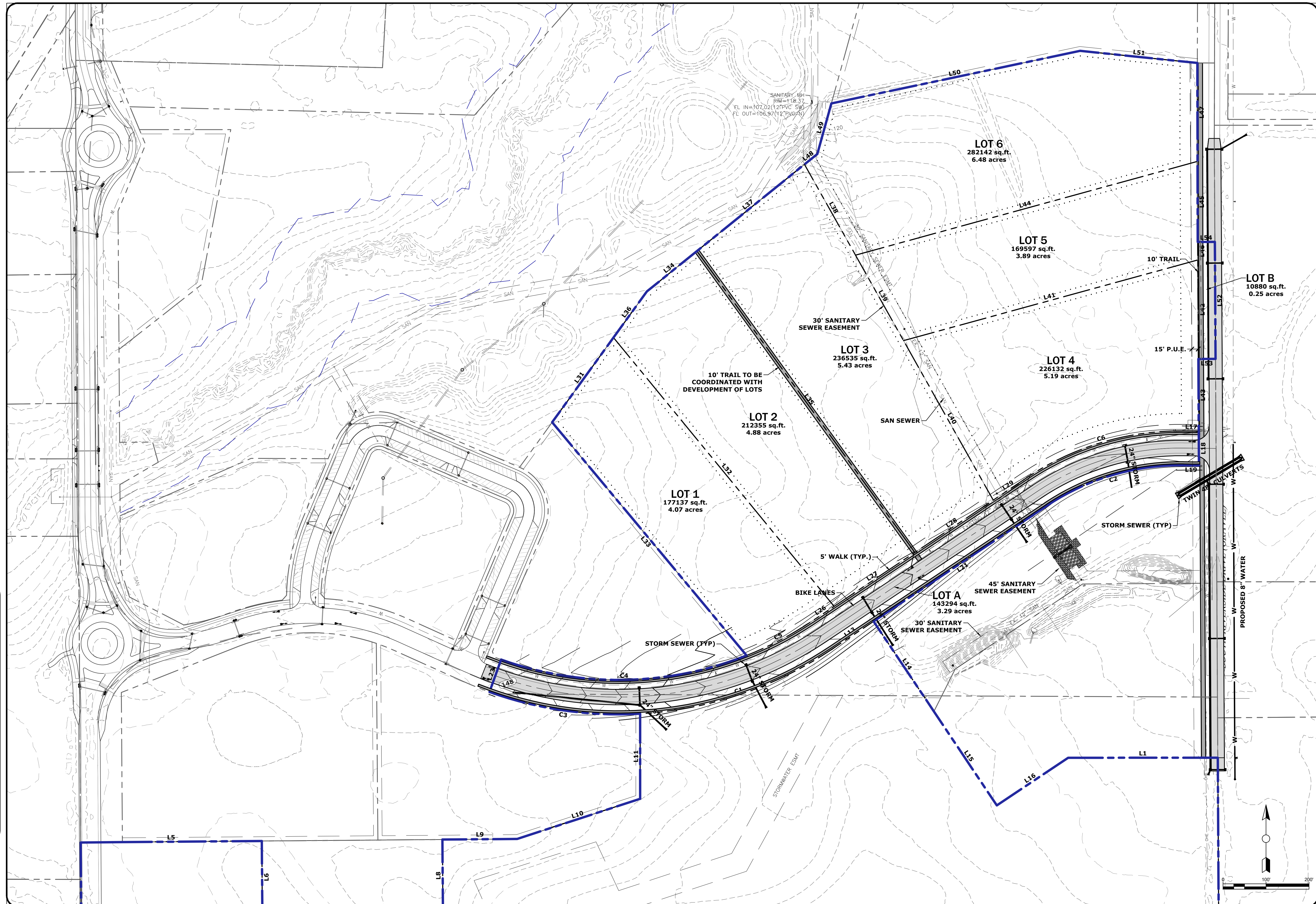

DATE	BY	REVISION
08/19 <td>ELT <td>DESIGNED</td> </td>	ELT <td>DESIGNED</td>	DESIGNED
08/19 <td>ELT <td>DRAWN</td> </td>	ELT <td>DRAWN</td>	DRAWN
		CHECKED
		LAST UPDATE: 8/20/19

FOX Engineering Associates, Inc.
414 South 17th Street, Suite 107
Ames, Iowa 50010
Phone: (515) 233-0000
FAX: (515) 233-0103

FOX Engineering

PHASE FOUR - 2ND ADD. PRELIMINARY PLAT (NORTH)
IOWA STATE UNIVERSITY RESEARCH PARK
PHASE FOUR - 1ST ADDITION
IOWA STATE UNIVERSITY
AMES, IOWA

PROJECT NO.
5136-19B

SHEET
C2.2

DRAWING FILE NAME
K:\PROJ\5000\5136-19B\ISURP 4th Addition\Drawings\Civil\5136-19A PRE-PLAT.dwg

PLOT STYLE TABLE
FoxGrayScale.ctb

LAYER MNGR NAME
LAYOUT NAME
C2.3

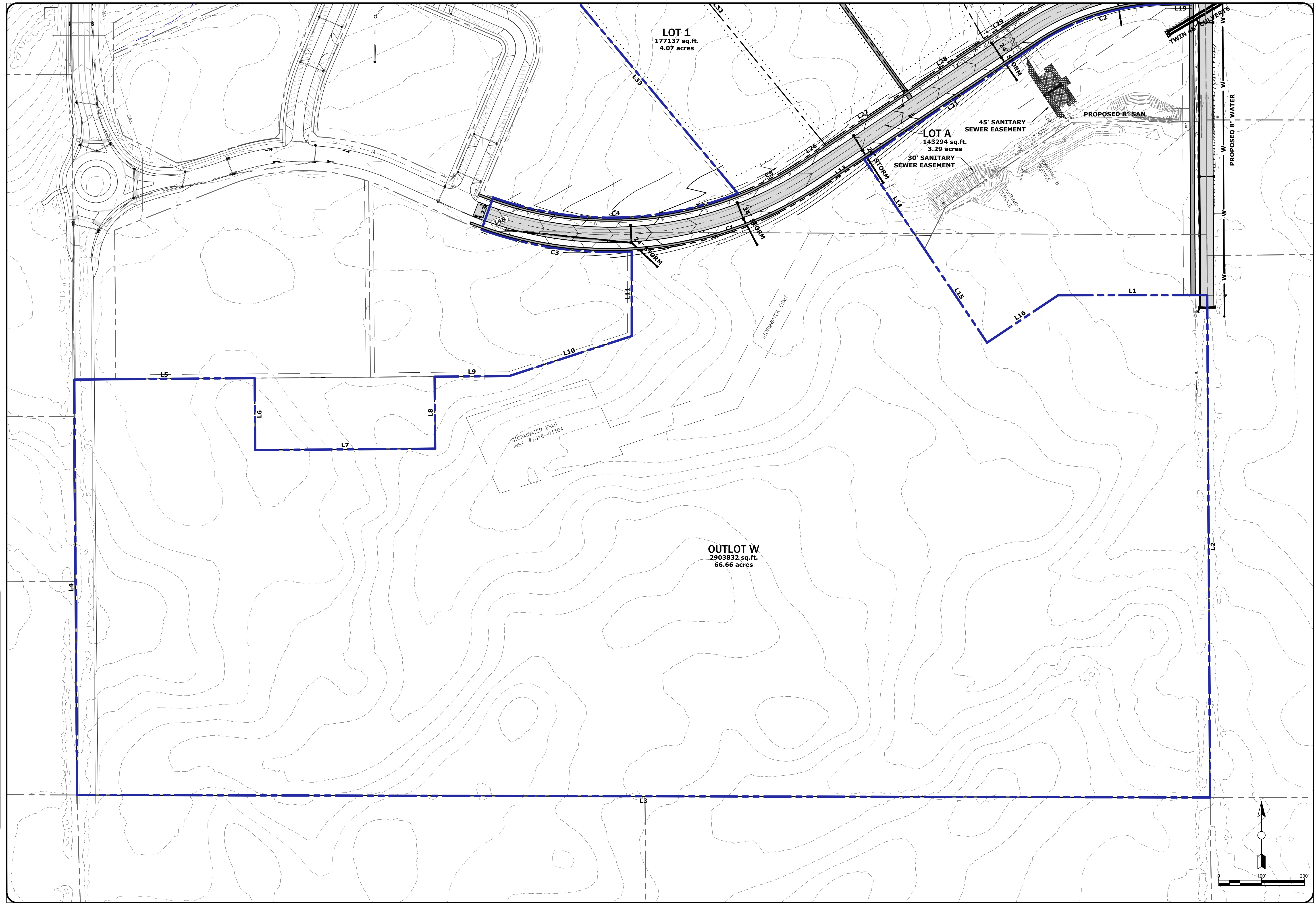

DATE	08/19
BY	ELT
DESIGNED	ELT
DATE	08/19
BY	ELT
DRAWN	ELT
CHECKED	
LAST UPDATE:	8/20/19

REVISION	
DATE	

FOX Engineering Associates, Inc.
414 South 17th Street, Suite 107
Ames, Iowa 50010
Phone: (515) 233-0000
FAX: (515) 233-0103

FOX engineering

PHASE FOUR - 2ND ADD. PRELIMINARY PLAT (SOUTH)
IOWA STATE UNIVERSITY RESEARCH PARK
PHASE FOUR - 1ST ADDITION
IOWA STATE UNIVERSITY
AMES, IOWA

PROJECT NO.
5136-19B

SHEET
C2.3

Staff Report

Vacation Lodging

July 23, 2019

BACKGROUND:

City Council provided direction on June 18, 2019 to have this item brought back concurrent with the City Council's broader discussion related to Rental Housing regulations of Chapter 13 of the Ames Municipal Code. In coordination with a follow-up to that discussion on this same agenda, staff is returning this item to the Council for discussion and consideration.

At the City Council meeting on April 23, 2019, Council had indicated a desire to have a separate discussion and determination on the appropriateness of permitting Vacation Lodging (previously referred to as Vacation Rentals) in single family areas in light of the changes in state law regarding rental limitations. Staff was directed to remove the specific use from consideration of the proposed ordinances establishing Guest Lodging licensing (previously referred to as Short-Term Rentals) that are also on this agenda for consideration and possible first reading. Although Vacation Lodging is not a rental use subject to the state law changes, it had intertwined expectations related to the Rental Code and the previous Rental Cap Neighborhoods.

Therefore, the purpose of this staff report is to give Council the opportunity to review, discuss, and determine if, or how to, move forward with code language governing Vacation Lodging. As a reference, a summary of the former draft language for Vacation Lodging is included within the Addendum.

Vacation Lodging means the use of an entire dwelling unit that is not the owner's primary residence for short term lodging and is the dwelling is generally offered as available for commercial purposes through an online marketplace. Vacation Lodging may be offered on an ongoing basis throughout the year as long as each guest contract is for 31 days or less. This definition treats the use as a principal use of lodging rather than as an accessory use to household living as is the case with the other short term lodging options

In October 2018, Staff's snapshot inventory indicated that 28 listings (out of a total of 51) or 55% were entire dwelling unit (Vacation Lodging) offerings. These units were generally dispersed geographically throughout the city as well as being dispersed among the various zoning districts. **Staff anticipates that the number of Vacation Lodging dwellings would increase with legalization and awareness of the short-term rental options available, as**

Staff has received many numerous inquiries from investors. In addition, offerings for Vacation Lodging appears to be growing both locally and as a national trend.

Staff reviewed a sampling of approaches by other cities on this topic. Most communities recognize a difference between a hosted home share as an incidental, accessory use to Household Living and Vacation Lodging as a different type of use, which is more impactful of neighborhoods. The primary concerns with allowing a short term lodging use in a residential area are impacts to housing supply for true household living needs and the transient nature of occupants (atypical parking needs, activity levels, familiarity with individuals, frequent changing of occupants).

A large variation of approaches is utilized around the country as a means of restricting Vacation Lodging along with licensing. Some of these include:

- Prohibit all together (some cities are backtracking from previously permitting to restricting, such as Nashville)
- Allow only in higher density/commercial zoning districts
- Cap the % of licenses that may issued
- Impose a separation distance between licensed Vacation Lodging units

If the City Council chose to proceed with allowing for the use, the following are five methods that may address concerns related to use.

Option 1- Original Proposal April 28th- Allow Vacation Lodging as previously proposed in all zoning districts where Guest Lodging may occur subject to a Special Use Permit.

Continue with previously proposed language requiring a Letter of Compliance and a Special Use Permit with the exceptions and exemptions for apartment rentals. The original process included a Special Use Permit requirement within low density areas to address unique conditions of a property or neighborhood. The Special Use Permit process can address individual concerns of a site, but does not address cumulative issues of a high concentration of units very well.

The primary concern with this option is that with the removal of the Rental Cap, there is an increased likelihood of pressure for acquiring homes for investment purposes in near campus areas and leading to potential over concentration of the use along with high levels of rental occupied properties.

Option 2- Limit Vacation Lodging Based Upon Citywide Base Zoning Districts.

City Council could limit by base zoning district citywide where the use is allowable. **City Council could choose to allow the use in higher density areas and prohibit it in low density residential zoning districts and areas intended for single family conservation,** such as: RL & FS-RL, PRD, UCRM, O-SFC. Based upon Staff's snapshot inventory (October 2018), 21% of Vacation Lodging units were located within the above mentioned low density residential zoning districts. This approach would allow for use of apartments for this use subject to the proposed 10% limitation originally discussed in the draft ordinances from the

April 28th. The proposed zoning districts allowing the apartment use included: RM, RH, FS-RM, NC, CCR, DSC, CSC, AND DGC.)

Restrictions of use within a zoning district is a common approach within the zoning ordinance. Prohibiting the use is the only direct way to address concentration or cumulative issues of allowing the use.

Option 3- Limit Vacation Lodging by an Overlay

If concentration issues are the primary concerns for certain areas of the City but not uniformly across the City, using overlay would be appropriate. Based upon Staff's snapshot inventory (October 2018), 11% of Vacation Lodging units were located within low density residential university-impacted neighborhoods.

This option could be accomplished by creating a new overlay for specific areas established within either the Zoning Ordinance if it requires specific use related controls, or it could be an element of the Chapter 35 Licensing.

Option 4- Separation Distance

If the primary concern with the use is over concentration and cumulative impacts of the use, a minimum separation distance could be created for lower density residential areas. This would assume a Special Use Permit is required, but include a specific distance separation requirement.

An example of this approach is a 500-foot separation standard for supervised transitional living uses in the Zoning Ordinance. A property owner would require approval of a variance to operate Vacation Lodging if they did not meet a separation standard. The simplest approach is a uniform radial distance requirement, likely similar to city block length of 300 feet or the 500-foot separation of a transitional home.

Option 5- Licensing Requirements

A different approach from land use management would be to change the licensing and operational requirements as described in the proposed Chapter 35 ordinance on this agenda. Additional or different standards could be added to address operational or conduct concerns. One concept proposed on April 28th was to include a "local" contact as a requirement. Staff did not initially propose this requirement due to uncertainty in what specific issues it could address about operations, especially if the issue is guest conduct based vs property upkeep. If City Council believes this would create better accountability we would need to identify what an appropriate proximity to the City is and intended level of responsiveness to contact by City officials.

STAFF COMMENTS:

If City Council finds it appropriate to direct staff to bring draft language of a text amendment forward for a public hearing any one of these options are seen by staff as readily able to be

implemented. Staff presumes that with any direction to proceed on allowing the use, Council would intend for licensing of the units to be required in addition to the compliance with the Rental Code. **If City Council does not choose to allow for the Vacation Lodging use, with approval of the proposed ordinances on this agenda, the City would allow for primary residents of homes to operate short term lodging uses, just not absentee whole house lodging as a principal use.**

ADDENDUM

Previously Proposed Text related to Vacation Lodging

Vacation Lodging is an investment property that is made continuously available for short-term usage.

The allowance of Vacation Lodging as a transient occupancy use in residentially zoned areas has the potential to be incompatible with surrounding residential uses. Therefore, special regulation for short-term occupancy is necessary to ensure that Vacation Lodging use will be compatible with surrounding residential uses and will not materially alter the character of neighborhoods in which they are located.

Of the short-term rental types, the on-going transitory use of the dwelling makes Vacation Lodging the most impactful on a neighborhood. As such, Vacation Lodging cannot be considered an accessory use to Household Living. Rather, it would be considered to be a new type of principal use under short-term lodging.

In order for Vacation Lodging to be licensed, the dwelling would first require registration and inspection under the City's Rental Housing Code. Occupancy limitations would be aligned with the Rental Housing Code, Section 13.503. and would not exceed a total of five adults.

Additionally, Vacation Lodging would be subject to the scrutiny of the special use permitting process to address unique conditions of an area and individual property. A licensing application would be required that would be administratively approved, once both rental code compliance and the special use permit is granted. Rental apartments would be licensed with one license per parcel or development. However, a 10% restriction would be placed upon the total percentage of rental apartment units allowed as Vacation Lodging. Rental apartments located in a Residential Low Density (RL) zoning district would not be permitted to operate as Vacation Lodging. Conversely, rental apartments would be exempt from the special use permit requirement in certain commercial and higher density residential zoning districts. The zoning tables located within the Zoning Ordinance would provide guidance.

Summary of previous Vacation Lodging standards:

- Annual License required
- Applicant is the Property Owner
- Local Contact Information / Property Representative required
- Available in any housing type
- The dwelling unit is located in a zoning district permitting their use: A, RL, RM, UCRM, RLP, RH, F-VR, FS-RL, FS-RM, F-PRD, S-SMD, NC, CCR, DSC, CSC, or DGC, with the exception that apartment rentals located within the RL zoning district may NOT be utilized as Vacation Lodging.
- Occupancy Limitations based upon Ames Municipal Code Section 13.503; may not exceed five adults.
- Off-Street Parking- 1 space per bedroom (maximum required - 5 spaces). Apartment rentals in zones with less parking required are not subject to this standard.
- Subject to Tax Compliance.
- Special Apartment Restrictions or Exemptions-
 - RL Zoning. Apartment rentals located within the RL zoning district may NOT be utilized as Vacation Lodging.

- Percentage of Apartment Rentals within One Parcel. The short-term usage of apartment rentals as Vacation Lodging [by the property owner] within a single parcel or common development is restricted to the greater of one dwelling unit or up to 10% of the total number of units located within a parcel or common development.
- Letter of Compliance- may not advertise or operate without a valid LOC in effect.
- Special Use Permit required prior to licensing. Exemptions included for apartment rental units located in certain zoning districts, including: RM, RH, FS-RM, NC, CCR, DSC, CSC, AND DGC.
- Concurrent Guest Contracts not allowed within a dwelling unit.
- Mandatory postings of license.
- Registry of Guests required.
- Ongoing Compliance required and responsiveness to any complaints.
- Same Application Submittal and Review, approval, non-renewal, and revocation as Guest Lodging.
- Considered as a new principle use within the Zoning Ordinance (Chapter 29) under Short-Term Lodging, within the zoning district tables.

COUNCIL ACTION FORM

SUBJECT: VACATION OF ALLEY RIGHT-OF-WAY NORTH OF LINCOLN WAY AND EAST OF ELM AVENUE AND CONVEYANCE TO FOREST PARK PROPERTIES, LLC

BACKGROUND:

City of Ames staff was approached by Kent Cooper, representing Forest Park Properties LLC, requesting the vacation and conveyance of 16' X 180' of public alley right-of-way (ROW). Forest Park Properties owns several parcels adjacent to this alley, which is north of Lincoln Way and runs east from Elm Avenue to a dead end (see Attachment A for a location map). Mr. Cooper has stated that this will facilitate more efficient use of his properties and possibly allow his parking to be organized into a more effective layout.

Forest Park has frontage on both sides of the alley totaling 300'. Also, Greater Iowa Credit Union (GICU) has an annex building on the north side of the alley with 60' of frontage. GICU has stated that they are not interested in obtaining the portion of right-of-way that is adjacent to their building (there is no pedestrian or vehicle access to GICU from the alley). The City of Ames Municipal Electric Services also has an overhead three phase line running along the north side of the alley. This is the only known utility utilizing this alley. **If City Council decides to vacate and convey this right-of-way, a Public Utility Easement (PUE) will be obtained by September 24, 2019 over the entire alley area. In addition to the PUE, the easement will also allow GICU to access the rear of their parcel for building maintenance.**

The right-of-way valuation according to the City's standard formula (Attachment B) is \$18,446.40, which is based on adjacent land values minus 10% for quit claim deed and 15% for retaining an easement. **The alley pavement is currently in a severely deteriorated condition. If the City was to retain this right-of-way, a project would need to be programmed for a complete reconstruction of the pavement. Staff has estimated this cost at approximately \$65,000. If the alley is vacated and conveyed to Forest Park Properties, they would assume all maintenance responsibilities in conjunction with maintaining their adjacent properties. Therefore, staff recommends this alley be vacated and conveyed to Forest Park Properties for \$1.00.**

ALTERNATIVES:

1. a. Set the date of public hearing as August 27, 2019 for the 1st reading to approve the vacation of the 180' X 16' alley ROW north of Lincoln Way and east of Elm Avenue.
- b. Set the date of public hearing as September 24, 2019 to approve the conveyance of the vacated public ROW to the adjacent owner Forest Park Properties, LLC for \$1.00.

2. a. Set the date of public hearing as August 27, 2019 for the 1st reading to approve the vacation of the 180' X 16' alley ROW north of Lincoln Way and east of Elm Avenue.
 - b. Set the date of public hearing as September 24, 2019 to approve the conveyance of the vacated public ROW to the adjacent owner Forest Park Properties, LLC for \$18,446.40.
3. Retain the 180' X 16' alley ROW.

MANAGER'S RECOMMENDED ACTION:

The practical use of this alley only serves as access to the parcels owned by Forest Park Properties. It provides no purpose for public access. An easement will be retained over the entire alley to allow access to and maintenance of the City electric facilities and allow GICU access to maintain their building. This easement will be drafted by City legal staff and executed prior to the public hearing on September 24, 2019. Conveying the alley would also allow to City to forego reconstructing the alley, which has an estimated cost of \$65,000.

Therefore, it is the recommendation of the City Manager that the City Council adopt Alternative No. 1 as noted above.



ArcGIS Web Map

Attachment A



© City of Ames, Iowa makes no warranties, expressed or implied, including without limitation, any warranties of merchantability or fitness for a particular purpose. In no event shall the City of Ames be liable for lost profits or any consequential or incidental damages caused by the use of this map.

Date: 7/12/2019

1 inch = 94 feet

ATTACHMENT B

PROPOSED SALE OF CITY LAND

16' x 180' alley ROW area north of Lincoln Way and east of Elm Ave

Address	Assessed SF	Assessed 2019 Land Value	\$/SF
110 Elm Avenue	2,800	\$18,500	\$6.61
821 Lincoln Way (rear)	2,750	\$11,600	\$4.22
819 Lincoln Way	10,317	\$160,800	\$15.59
801 Lincoln Way	84,023	\$830,700	\$9.89
836 2nd Street	20,640	\$132,100	\$6.40

Average Cost/SF	\$8.54
-----------------	--------

ROW Adjacent to:	Sale Area (SF)	Value of Sale Area	Value (Less 10% for Deed & 15% for Easement)
Forest Park Properties	2400	\$20,496	\$15,372.00
Greater IA Credit Union	480	\$4,099	\$3,074.40

Total Value	\$18,446.40
-------------	-------------

ITEM#: 47
 DATE: 08-27-19

COUNCIL ACTION FORM

SUBJECT: 2018/19 ASPHALT STREET PAVEMENT IMPROVEMENTS – (RELIABLE ST, FLORIDA AVE, DELAWARE AVE, AND HUTCHISON ST)

BACKGROUND:

This is the annual program for reconstruction or resurfacing (rehabilitation) asphalt streets, typically located with residential neighborhoods. Rehabilitation of existing asphalt streets is possible where the base asphalt layer is solid, but the surface course has failed. Full-depth replacement of these streets is necessary in cases of structural pavement failure. This program was created in accordance with City Council’s goal of strengthening our neighborhoods. **This project is in the area of Reliable St, Florida Ave, Delaware Ave, and Hutchison St.**

Staff held a public meeting to obtain input on staging, construction timing, and special access needs. Comments were received and incorporated into the project design

City of Ames staff has completed plans and specifications for this project with a base bid and then alternatives for the type of pavement used on the reconstruction project. **Alternative A will be for using asphalt and Alternative B is for using concrete.** A table of total estimated costs for each Alternative is shown below:

	<u>Base + Alt A (asphalt)</u>	<u>Base + Alt B (concrete)</u>
Base Bid	\$ 777,870.50	\$ 777,870.50
Paving Alternative	<u>\$ 373,495.00</u>	<u>\$ 527,988.00</u>
Construction Subtotal	\$ 1,151,365.50	\$ 1,305,858.50
Engineering	<u>\$ 175,000.00</u>	<u>\$ 195,000.00</u>
Total Project Costs	\$ 1,326,365.50	\$ 1,500,858.50

On August 21, 2019, bids for the project were received as follows:

<i>Bidder</i>	<i>Base+Alt A Amount</i>	<i>Base+Alt B Amount</i>
Engineer’s estimate	\$1,151,365.50	\$1,305,858.50
Con-Struct Inc.	N/A	\$1,002,621.40
Manatts Inc.	\$1,081,531.74	N/A

Revenue and expenses associated with this program are estimated as follows:

	Available Revenue	Estimated Expenses
G.O. Bonds	\$ 1,400,000	
Construction (Low Bid: Base + Alt B)		\$1,002,621.40
Engineering/Administration (Est.)		\$ 195,000.00
	<hr/>	<hr/>
	\$ 1,400,000	\$1,197,621.40

ALTERNATIVES:

1. a. Accept the report of bids for the 2018/19 Asphalt Street Pavement Improvements – (Reliable St, Florida Ave, Delaware Ave, and Hutchison St) Project.
- b. Approve the final plans and specifications for this project.
- c. Award the 2018/19 Asphalt Street Pavement Improvements – (Reliable St, Florida Ave, Delaware Ave, and Hutchison St) project to Con-Struct Inc. of Ames, Iowa, in the amount of \$1,002,621.40.
2. Award the contract to one of the other bidders.
3. Do not proceed with this project.

MANAGER'S RECOMMENDED ACTION:

By approving final plans and specification and awarding the contract, this project will result in lower street maintenance costs, improve area drainage, and provide a better neighborhood aesthetic.

Therefore, it is the recommendation of the City Manager that the City Council adopt Alternative No. 1, as noted above.

COUNCIL ACTION FORM

SUBJECT: AMENDMENT TO ZONING LIMITATIONS OF 100% OVER 55-YEARS OF AGE OR OLDER RESIDENCE REQUIREMENT FOR 415 STANTON AVE ZONED RH (RESIDENTIAL HIGH DENSITY).

BACKGROUND:

In January 2018, City Council approved a contract rezoning for 415 Stanton Avenue (Attachment A: Location Map). This contract rezoning agreement had four conditions (Attachment B). The conditions were agreed upon to facilitate the rezoning of the site to High Density Residential after a number of meetings with neighborhood representatives and City staff. Three of the four conditions were related to design and reuse of the existing building. All three of these conditions have been met. **The fourth condition restricted the age of residents to at least one occupant of each unit being at least 55 years of age.** This limitation was intended at that time to exceed federal housing standards for *Housing for Older Persons Act* (HOPA) that allow for certain housing projects to be “senior” only housing.

Since approval of the rezoning and site development permit for the project, the developer had created a condominium regime for individual ownership. At this time there are eleven different owners. The majority owner, Crawford Ames, LLC, also the developer, submitted the application for rezoning. The original zoning contract states that all successors and assigns of Crawford Ames, LLC must sign off on any changes, meaning all eleven properties owners will need to sign the new zoning contract to allow for the requested change to the age restriction.

AGE RESTRICTION TO 55 OR OLDER:

The rezoning request is to amend the resident age limitation to reduce the number of age-restricted units from 100 percent to 80 percent of the units. The proposed change would meet minimum criteria for categorizing a project as Housing for Older Persons. The minimum percentage requirement under HOPA is 80% of occupied dwelling units.

The developer’s statement says that only 6 of the 30 units in the building would be without the age restriction (Attachment C). The developer seeks this change to expand their marketing ability for the units. The developer indicated that they have met with some of the residents of the surrounding neighborhood to discuss the proposal. Staff has not received any comments on the proposal.

At a public hearing on August 7, 2019, the Planning and Zoning Commission voted (5-0) to recommend that the City Council approve the request to amend the contract rezoning agreement to specify the use is limited to Senior Living with one occupant per dwelling

as 55 or older in a minimum of 80 percent of the units, in compliance with the federal Housing and Urban Development (HUD) standards for Housing for Older Persons.

The Commission and a member of the public questioned how the age restriction would be monitored and verified. The applicant/property owner clarified that that every 24 months there is a survey that the Association is required to complete to achieve the 80 percent over/20 percent under the age of 55 years of age requirement. He stated that at any time someone from Housing and Urban Development (HUD) can inventory their records. Staff confirmed that the City is not part of the age verification process.

The Commission also questioned how sales would occur if the number of age-restricted units is already filled. The applicant/property owner explained that the Association would have an interview process and have the discretion to approve buyers that would potentially be purchasing units in the 20 percent of units that are not age restricted.

ALTERNATIVES:

1. The City Council can do the following:
 - A. Open the public hearing to discuss the proposal.
 - B. Direct the applicant to provide signatures authorizing the proposed amendment by all owners subject to the current agreement to allow for a use limitation of Senior Living with one occupant per dwelling as 55 or older in a minimum of 80 percent of the units, in compliance with the federal Housing and Urban Development (HUD) standards for Housing for Older Persons Act.
 - C. Continue the public hearing until September 10th to allow receipt of the signed agreement before first reading on a rezoning ordinance.
2. The City Council can deny the request to amend the contract rezoning agreement to specify the use is limited to Senior Living with one occupant per dwelling as 55 or older in a minimum of 80 percent of the units, in compliance with the federal Housing and Urban Development (HUD) standards for Housing for Older Persons.
3. The City Council can defer action on the request to amend the contract rezoning agreement and request additional information from the applicant.

CITY MANAGER'S RECOMMENDATION:

The applicant requests the change of the use limitation of the property to align directly with the federal HOPA standards compared to exceeding the HOPA requirements with the current obligation to have 100% of the units with a resident that is 55 or older. Staff believes the request is consistent with the intent of the original rezoning request and can be found to be appropriate for the site. However, at this time the developer has not obtained written authorization from all known property owners (condominium owners) to

proceed with City Council approval of the requested change. State law requires that written agreement for conditions must be provided prior to conclusion of a public hearing for a rezoning amendment. To move forward with the project, City Council would need to direct the applicant to proceed with obtaining signatures and continue the hearing to September 10th.

Therefore, it is the City Manager's recommendation that the City Council provide direction to staff on Alternative #1.

ATTACHMENT A: LOCATION MAP

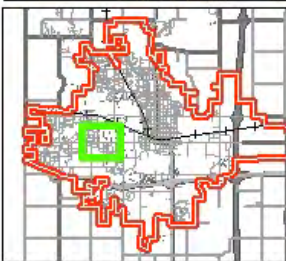

**Location Map
415 Stanton Avenue**

ATTACHMENT B: EXISTING ZONING CONTRACT

Instrument #: 2018-00901
02/01/2018 08:43:31 AM Total Pages: 4
00 OTHER
Recording Fee: \$ 22.00
Stacie Herridge, Recorder, Story County Iowa



S P A C E A B O V E R E S E R V E D F O R O F F I C I A L U S E

Legal description: See page 4.

Return document to: City Clerk, 515 Clark Avenue, Ames IA 50010

Document prepared by: Victoria A. Feilmeyer, City of Ames Legal Department, 515 Clark Ave., Ames, IA 50010 – 515-239-5146

**CONTRACT REZONING AGREEMENT PERTAINING TO THE
LAND AT 415 STANTON AVENUE**

THIS AGREEMENT, made and entered into this 23 day of January, 2018, by and between the City of Ames, Iowa (hereinafter called "City") and The Crawford Ames, LLC, an Iowa limited liability company (hereinafter called "Developer"), its successors and assigns.

WITNESSETH THAT:

WHEREAS, the Developer owns real property which had formerly been used by the Ames Community School District for an elementary school and later for school district offices, legally described as set out on Attachment A and locally addressed as 415 Stanton Avenue, Ames, Iowa, (hereinafter called the "Property"); and

WHEREAS, the Developer desires to redevelop the property so that it may be intended and operated for occupancy as Housing for Older Persons aged 55 years or older; and

WHEREAS, the City approved a Minor Map Amendment to the Land Use Policy Plan (LUPP) designation for the subject real property by Resolution 17-676, which changed its designation from Low-Density Residential/Governmental Lands to High Density Residential to provide for a LUPP designation compatible with the proposed Housing for Older Persons; and

WHEREAS, the Developer has applied for a zoning designation of RH (Residential High Density) for the subject property in order to advance its plan of renovating the site to be used as Housing for Older Persons; and

WHEREAS, as contemplated by Iowa Code section 414.5, the City desires to impose certain additional conditions on the property owner in addition to existing regulations in connection with granting the base zoning; and

WHEREAS, both City and the Developer expressly agree that said additional conditions are reasonable and imposed to satisfy public needs which are directly caused by the requested zoning change to RH (Residential High-Density).

NOW, THEREFORE, the parties hereto have agreed and do agree as follows:

I. INTENT AND PURPOSE

A. It is the intent of this Agreement to:

1. Recognize that the Developer, The Crawford Ames, LLC, is the owner of the real property being rezoned and expressly agrees to the imposition of additional conditions as authorized by Iowa Code section 414.5.
2. Confirm and document that the Parties recognize and acknowledge that a substantial benefit to the public will be realized by imposition of the additional conditions for rezoning.
3. Grant rezoning of the real property from Government/Airport Lands (S-GA) to Residential High Density (RH) subject to these additional conditions:
 - a. The residential use of the site is age restricted to Housing for Older Persons with each unit having at least one occupant who is 55 years of age or older.
 - b. The existing Crawford School Building will be retained and adapted to residential use.
 - c. New development shall be restricted to a maximum of three stories no more than 50 feet in height in the aggregate.
 - d. Prior to the approval of the third reading of the Ordinance rezoning the property, this rezoning agreement must be signed by the Developer and delivered to the City.

II. GENERAL PROVISIONS

A. Modification. The parties agree that this Agreement may be modified, amended or supplemented only by written agreement of the parties, and their successors and/or assigns.

B. General Applicability of Other Laws and Ordinances. The Developer understands and agrees that all work done by or on its behalf shall be made in compliance with Iowa Code, the Ames Municipal Code, Iowa Statewide Urban Design and

Specifications and all other federal, state and local laws of general application (including the Fair Housing Act as applicable), whether or not such requirements are specifically stated in this agreement. All ordinances, regulations and policies of the City now existing, or as may hereafter be enacted, shall apply to activity or uses on the site.

C. Incorporation of Recitals and Exhibits. The recitals, together with any and all exhibits attached hereto, are confirmed by the parties as true and incorporated herein by reference as if fully set forth verbatim. The recitals and exhibits are a substantive contractual part of this agreement.

III. COVENANTS RUN WITH THE LAND

This Agreement shall run with the site and shall be binding upon the Developer, its successors, subsequent purchasers and assigns. Each party hereto agrees to cooperate with the other in executing a Memorandum of Agreement that may be recorded in place of this document.

IN WITNESS WHEREOF, the parties hereto have caused this instrument to be executed effective as of the date first above written.

<p>CITY OF AMES, IOWA</p> <p>By <u><i>John A. Haila</i></u> John A. Haila, Mayor</p> <p>Attest <u><i>Diane R. Voss</i></u> Diane R. Voss, City Clerk</p> <p>STATE OF IOWA, COUNTY OF STORY, ss: On this <u>23</u> day of <u>January</u>, 201<u>8</u> before me, a Notary Public in and for the State of Iowa, personally appeared John A. Haila and Diane R. Voss, to me personally known, who, being by me duly sworn, did say that they are the Mayor and City Clerk, respectively, of the City of Ames, Iowa; that the seal affixed to the foregoing instrument is the corporate seal of the corporation, and that the instrument was signed and sealed on behalf of the corporation by authority of its City Council, as contained in Resolution No. <u>18-046</u> adopted by the City Council on the <u>23</u> day of <u>January</u>, 201<u>8</u>, and that John A. Haila and Diane R Voss acknowledged the execution of the instrument to be their voluntary act and deed and the voluntary act and deed of the corporation, by it voluntarily executed.</p> <p><u><i>Jill L. Ripperger</i></u> Notary Public in and for the State of Iowa</p>	<p>THE CRAWFORD AMES, LLC</p> <p>By <u><i>[Signature]</i></u></p> <p>STATE OF IOWA, COUNTY OF STORY, ss: This instrument was acknowledged before me on <u>January 8</u>, 201<u>8</u> by <u>LUKE JENSEN</u>, as Manager, of The Crawford Ames, LLC</p> <p><u><i>Jill L. Ripperger</i></u> Notary Public in and for the State of Iowa</p> <div data-bbox="873 1266 1214 1352"></div>
-----------------------------------------------------------------------------------------------------------------------------------------------------------------------------------------------------------------------------------------------------------------------------------------------------------------------------------------------------------------------------------------------------------------------------------------------------------------------------------------------------------------------------------------------------------------------------------------------------------------------------------------------------------------------------------------------------------------------------------------------------------------------------------------------------------------------------------------------------------------------------------------------------------------------------------------------------------------------------------------------------------------------------------------------------------------------------------------------------------------------------------------------------------------------------	---------------------------------------------------------------------------------------------------------------------------------------------------------------------------------------------------------------------------------------------------------------------------------------------------------------------------------------------------------------------------------------------------



ATTACHMENT C: APPLICANT'S STATEMENT

415 Stanton Rezoning Request
July 16, 2019

Reason for Requesting Rezoning: The development team would like to amend the developer agreement to allow for adherence to Housing For Older Persons Act (HOPA). This change would allow for expanded residential opportunities for owners/occupants under the age of 55 (maximum of 20% or 6 units could be under age 55).

Consistency of this rezoning with the LUPP: The request is consistent with LUPP. The property is zoned RH with a contract. The contract stipulates that all units must have one occupant age 55 or older. This rezoning would still be consistent with the RH zone, but would amend the contract language.

Current Zoning: Residential High Density

Proposed Zoning: Residential High Density

Proposed Use: 55+ Adult Community that follows HOPA standards

Legal Description:

Lot Seven (7), except the South Five (5) Feet and the West Fifteen (15) Feet thereof; also the South Five (5) Feet of Lot Six (6); except the West Fifteen (15) Feet thereof, all in W.T. Smith's Addition to Ames, Iowa (to be confirmed by abstract).

The Crawford Condominiums Units #101-106, #201-216, #308-315

Land Area: 1.67 Acres

RECEIVED

JUL 23 2019

CITY OF AMES, IOWA
DEPT. OF PLANNING & HOUSING

COUNCIL ACTION FORM

SUBJECT: ADAPTIVE REUSE PLAN AMENDMENT TO CONSTRUCT A NEW BUILDING AT 2801 GRAND AVENUE

BACKGROUND:

In 2012, an Adaptive Reuse Plan/Major Site Development Plan (ADP) was approved for North Grand Mall that allowed changes to the existing building, construction of new buildings, and parking and landscaping improvements to the developed areas of the site. Adaptive reuse allows for some flexibility in design features to encourage retention of significant buildings in unique situations. The purpose of the adaptive reuse provisions in Section 29.306 of the Ames Municipal Code are stated as an intent to foster the renovation and reuse of structures that have historic, architectural, or economic value to the City and are vacant or at risk of becoming underutilized, vacant or demolished. It was determined previously that the North Grand Mall was of significant economic value to the City to support its adaptive reuse and allowances for waivers to certain parking and landscaping standards.

At that time, the plan focused on construction of new buildings at the south end of the site where the Kohl's building and other retailers are located. The plan also included a location for a future restaurant (referred to as Restaurant F) on Lot 2 in the northeast corner of the site, near the intersection of Grand Avenue and 30th Street, along with other assorted landscaping and parking improvements to the site (Attachment C). **The improvements planned for the north side of the site have not been completed and are the subject area of the proposed amendment (Attachment A).** A separate vacant area to the south of Fazoli's was also identified for a future Restaurant G, which has not been approved or built. There is a pending application for a fast food restaurant at that location.

Although the entire site is divided into different ownership, the site is viewed as one plan for all the properties due to the shared use of parking, access, and landscaping amenities with the 2012 Plan. The Walgreens property was not included as part of the 2012 ADP.

The applicant, Brent Haverkamp, representing the North Grand Mall ownership, submitted an application for approval of an amendment to the Adaptive Reuse Plan for development of a multi-tenant building that is approximately 7,166 square feet with a drive-through located at the northeast corner of the North Grand Mall site. The project also includes construction of sidewalks along the main driveway entrance from Grand Avenue to the Mall and the entrance from 30th Street to the Mall. The project includes a long-term plan for the redesign and improvement of the parking lot in the northeast corner of the site to enhance landscaping and restriping of the parking lot similar to the previously approved parking plan.

The Planning and Zoning Commission reviewed an initial submittal at its July 17th meeting for a proposed amendment to the 2012 Adaptive Reuse Plan (ADP) for a building with a front facing the mall and North Grand Avenue while having both a drive through tenant

space and a separate pick-up only tenant space with a patio along the east façade of the building. At that meeting, the Commission asked the applicant and staff for additional information on locating the proposed building closer to the street and enhancing architectural details and landscaping. The Commission was interested in the viability of siting the building near the corner to establish an architectural presence and for an opportunity to expand the outdoor patio space and make it a more inviting feature of the project.

Subsequent to the P&Z meeting, staff met with the applicant and explored additional options for building location and design details. The Planning and Zoning Commission reviewed example corner layouts from staff at its August 7th meeting and a revised submittal from the applicant that kept the building in its same location, but eliminated the pick-up window lane and enlarged the outdoor space on the east side. The current plan presented for Council approval was recommended for approval by the Commission with conditions at its August 7th meeting with a 5-0 vote. The applicant has made adjustments to the plan reflecting the Commission conditions for walkway connections and staff recommendations for realignment of the drive through exiting as are now presented to the City Council.

PROJECT DESCRIPTION:

The updated proposal includes a building designed for multiple tenants, with the south tenant bay designed as a drive-through facility. The drive-through lane would wrap the building with menu board on the west side and the service window located on the south façade. The front of the building will face Grand Avenue and will have a large outdoor patio. The patio will have planters and landscaping along the eastern edge to provide a barrier between the useable patio space and the parking lot. The west façade will function as a rear façade of the building not intended for customer access. The new sidewalk from Grand to the main entrance with associated parking and landscaping changes is also part of the Plan. (Attachment F). The overall disturbed area with new impervious surfaces is under the one-acre storm water threshold of Chapter 5b of the Municipal Code.

The Building

The building is designed as a one-story three bay one-story retail building with entrances on the east side of the building, facing Grand Avenue. The east side of the building will have a patio immediately adjacent to the building. The building materials are a mix of brick and fiber cement panels. The mix of building materials and colors will provide dimension to the building both visually and physically helping create a tenant identify within an intensity and cohesive design. The storefront glazing is also consistent with the character of the use and area. The variety of architectural features creates an appealing building aesthetically for its prominent location. Building elevations are included within Attachment F.

The Parking

The overall parking count for the mall site is as it exists today is approximately 1793 parking spaces. The existing parking layout will be impacted due to construction of this building and required circulation. Four existing rows of parking at the north end of the parking lot will be removed (167 spaces). New parking will wrap the new building, providing 75 stalls. This area is part of a larger lot, Lot 2 of Streets of North Grand Mall Subdivision.

Ultimately, there is a plan for the reconstruction and restriping of all of the parking area along North Grand, however, a timeline for the overall implementation has not been provided at this time (Attachment B).

With the proposed building requiring parking at a 4 stalls/1,000 square foot ratio, an additional 29 spaces would be needed to maintain the overall parking ratio for the site that was established with the 2012 plan. The 4 stalls/1,000 ratio is an amalgamation of retail and restaurant/entertainment parking rates unique to this site.

The North Grand Mall operator has also notified staff that it intends to lease space for a fitness facility, which is an allowed use in the zoning district, and to account for this new use as part of ADP. However, fitness uses require a higher parking ratio of 5 stalls/1,000 square feet compared to the approved standard since it was not addressed as an existing use in 2012. Additionally, the Orange Theory fitness facility (approx. 2,500 sq. ft.) was addressed in the same manner by staff. These uses are permissible under current conditions with their higher parking rates due to the small surplus of spaces indicated on the 2012 ADP, before accounting for the construction of any additional new buildings.

Parking Demand Calculations

Use*	Square feet	Ratio	Parking Required
Mall-“Commercial” (Existing Buildings per approved 2012 Plan)	416,783	4/1,000	1,667
Fitness Facilities (Existing Building Tenants)	20,500	5/1,000	103
New Building (2801 Grand)	7,166	4/1,000	29
Total Demand			1,799

* These figures do not account for temporary seasonal sales uses such as the Holub’s nursery

Staff’s calculations based upon the approved and proposed plans, and existing conditions, results in a change from 1793 parking spaces that exist today to 1703 spaces with the construction of the new building, and 1723 spaces upon the complete reconfiguration of the northeast parking lot. These figures do not include the Walgreen’s site or the vacant area at the south end of the site intended for a future restaurant.

The end result of the changes in tenants and new construction is a calculated demand of 1,799 spaces while providing for 1,723 with development of the new building. The applicant proposes approval a reduced parking requirement that has a stated number of parking spaces. This leads to a ratio of less than 4/1,000 with a parking ratio of approximately 3.75/1,000 square feet for commercial uses and 5/1,000 square feet for fitness uses at a combined level of approximately 3.88 spaces per 1,000 square feet of gross floor area overall.

The Landscaping

The 2012 ADP included allowances for reduced landscaping compared to Zoning Ordinance requirements of overall landscape percentages and specific planting requirements. Since that time, the City has also changed its landscaping requirements for parking lots and front yards. If this site were to comply with the current landscaping code

(Section 29.403(1)) an increase in trees, shrubs and grasses would be required compared to the 2012 approval.

The overall front yard planting plan includes ornamental trees and mix of grasses and shrubs, but the quantities of planting do not comply with the requirements of the current landscaping regulations. The landscaping along North Grand is similar to prior trees and shrub design standards while the 30th Street landscaping is more similar to current requirements with the inclusion of grasses. The proposed front yard planters are a minimum of seven feet along 30th Street and vary from seven to five feet along Grand Avenue reflecting the existing curb line. Current standards require a minimum yard depth of 10 feet with a reduction to seven feet when necessary to meet minimum parking requirements.

In addition to the front yard planting requirements, the landscaping code would require eight parking lot trees for the proposed plan in the area of the new building and parking. The proposed plan includes six trees in the area of the new building and two additional trees further south near the main entrance. New parking lot planters will be included with the future parking lot improvements. Planters within the existing parking lot will need to be excavated out to meet design and soil content requirements of the landscape standards.

Since this is an Adaptive Reuse Plan, waivers to required landscaping can be approved by the City Council. The City Council has the ability to decide that the landscaping as shown on the site plan is adequate for the purpose of enhancing the site and supporting reinvestment. Staff has included a condition related to the type of plantings for parking lot trees to incorporate appropriate shade trees rather than ornamental trees and for landscaping to be done with the construction of the new building. Future parking lot improvements and restriping are recommended to be deferred.

Other Features

The proposed plan shows changes to the main entrance to the mall (traffic signal at 28th Street). The changes are consistent with the improvements approved in 2012 for a sidewalk on the north side of the driveway connecting to the main mall entrance. This will be installed with approval of this amendment and prior to occupancy of the new building. The proposed plan also includes a direct sidewalk connection to the new building from Grand Avenue and a sidewalk along the 30th Street driveway to provide a connection to the mall and to the new building. The applicant has included an internal walkway connection as between the JC Penney sidewalk and the new building as part of raised median along the drive through lane as requested by the Planning and Zoning Commission. Other parking lot landscaping and islands will be added with the future parking lot improvement plan.

There are two existing seasonal uses in the area where the new building is proposed to go, Holub's and outdoor garden center and a walk-up snow cone hut. A Farmer's Market also operates in this general area. The applicant desires to be able to relocate both uses with the development of the northeast corner. Both uses are described as being moved to the west side of driveway to the area along 30th Street. Staff has not reviewed the site details on these locations, but believes the uses can be accommodated without disrupting circulation and access as temporary uses. Staff has included a condition to delegate review

of the siting of these uses by applying for a future Zoning Permit as necessary to reviewed and approved by the Planning Director.

SPECIFIC WAIVERS:

The proposed redevelopment does not conform to all Zoning Ordinance requirements. Under the adaptive reuse provision of Section 29.306, the City Council has the ability to grant waivers to some or all of the applicable Zone Development Standards of Section 29.805 and the General Development Standards of Article 4.

Following are the specific waivers to the Zone Development Standards being requested as modification from the 2012 approved landscaping and parking waivers:

- 1) ***Waiver of Front Yard and Parking Lot Landscaping requirements.*** The proposed front yard landscaping does not provide the required amount or mix of shrubs and grasses, or required overstory trees. A comparison is provided in the table below.

Front Yard Landscaping	Trees	Shrubs	Grasses
Grand Avenue			
Proposed:	4 (2 overstory)	0	16
2012 Approval	4	12	0
Current Requirement:	4	16	24
30th Street			
Proposed	4 (1 overstory)	24	0
2012 Approval	3	7	0
Current Requirement:	5	20	30

Additionally, the temporary parking and landscaping plan does not meet all parking lot tree planting requirements with six new trees in vicinity of the new building and two additional trees to the south. The reconstruction of the parking lot in the long term will add landscape planters and trees plantings, but no include full parking lot median improvements. Parking lot trees are required and are being provided.

- 2) ***Waiver of Parking.*** The ADP approved in 2012 applied a ratio of 4 parking stalls/1,000 square feet for the site for the described uses at that time. This standard a unique mixed parking rate standard for this site. The ADP did not address other uses for the site that did not exist at the time of the approval. The North Grand Mall operator has notified staff that it intends to lease space for a fitness facility, which is an allowed use in the zoning district. The applicant requests approval providing for 1723 parking spaces on the site for the proposed and existing mix of uses.

ALTERNATIVES:

- 1. The City Council can approve the amendment to the Adaptive Reuse Plan and Major Site Development Plan for 2801 Grand Avenue subject to the following stipulations:

- A. Complete the sidewalk improvements, parking reconfiguration, and landscaping adjacent to the main entrance drive into the mall site from Grand Avenue as shown on the plan, prior to occupancy for the new building at 2801 Grand Avenue.
 - B. Complete future parking lot improvements on Lot 2 with the future reconstruction of the parking lot.
 - C. Modify the Site Development Plan to include the following features subject to Planning Director approval:
 - i. Modifying landscape plan to replace crabapple trees abutting parking spaces with more appropriate species for the space.
 - ii. Future parking lot improvements to include additional shade trees within parking islands.
 - iii. Parking lot islands will need to be excavated out to create soil conditions to support trees. The planter areas will need to comply with current landscaping requirements regarding sizing and soil content.
 - D. Allow the existing seasonal/temporary uses (farmers market, nursery and walk-up snow cone hut) to be relocated to the north parking area between along 30th Street with a Zoning Permit reviewed and approved by the Planning Director.
 - E. Waive 76 parking spaces that would be required based on the 2012 ADP for the proposed project resulting in 1723 parking spaces on the site.
 - F. Allow for the front yard landscaping provided on the approved plan without meeting the required number of overstory trees, shrubs and grasses.
 - G. Allow for the Planning Director to approve outdoor lighting consistent with the Zoning Ordinance standards.
 - H. For uses and site improvements not included in the 2019 amendment, the approved 2012 ADP still applies.
2. The City Council can approve the amendment to the Adaptive Reuse Plan and Major Site Development Plan for 2801 Grand Avenue with modified conditions.
 3. The City Council can deny the amendment to the Adaptive Reuse Plan and Major Site Development Plan for 2801 Grand Avenue.

CITY MANAGER’S RECOMMENDED ACTION:

The proposed plan is change of use and configuration of the planned restaurant building for this corner compared to the 2012 ADP. The proposed plan accommodates a drive through use that does not impact the overall circulation of the site and creates an attractive new building space both architecturally and with its outdoor space as an enhancement to the commercial options on the site. **The overall benefits of keeping the existing mall**

and adding new uses support findings for approval of the Adaptive Reuse Plan amendment, even with the granting of waivers as requested to facilitate the design.

Therefore, it is the recommendation of the City Manager that the City Council accept Alternative #1, thereby approving the Adaptive Reuse/Major Site Development Plan for 2801 Grand Avenue with the specific waivers requested and stipulations noted above.

Attachment A: Location Map



2801 Grand Avenue

Attachment B: Future Parking Lot Improvement & Striping Plan

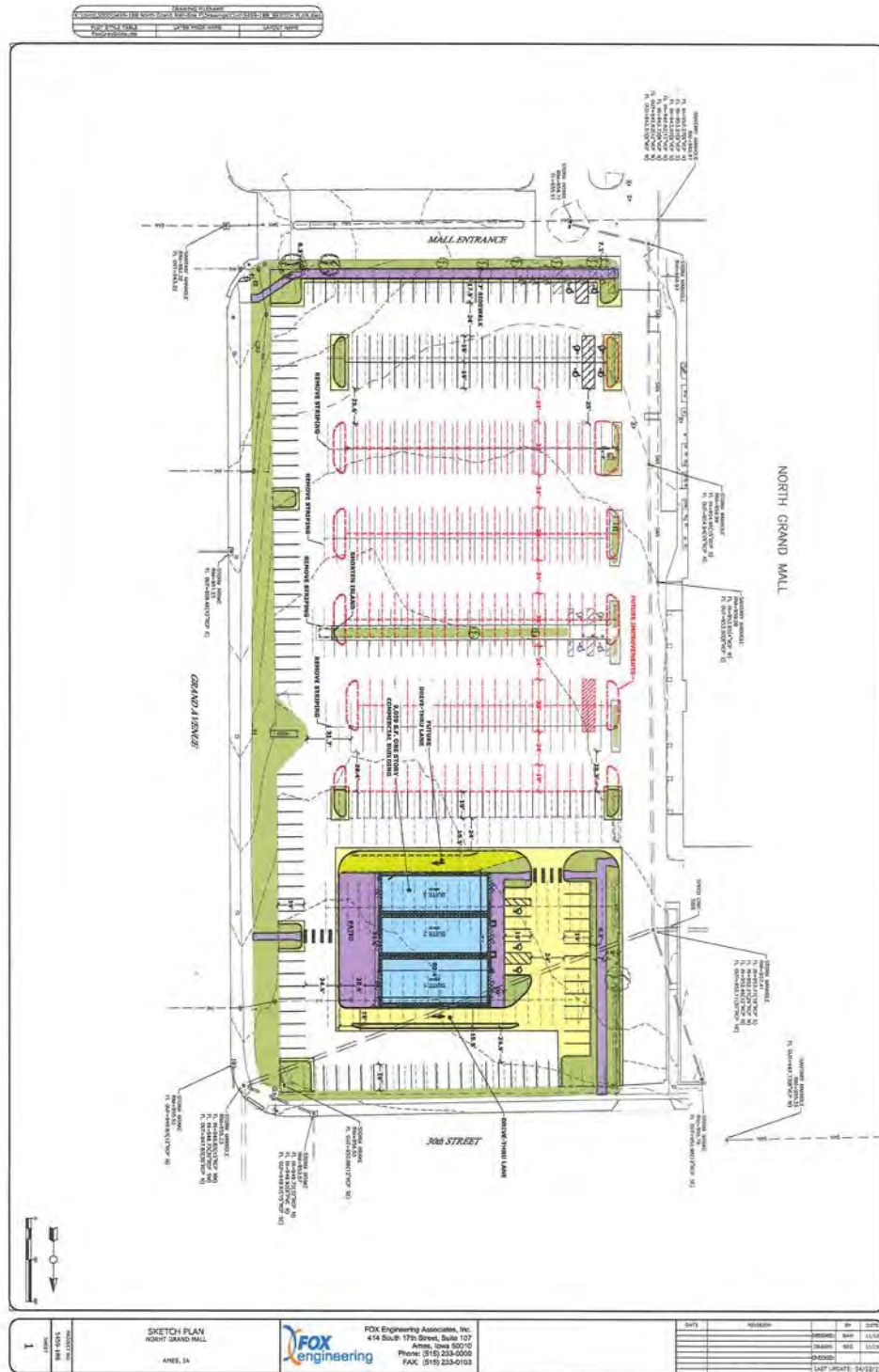

1 SHEET NO. 1 OF 1	SKETCH PLAN NORTH GRAND MALL AREA, IA	FOX Engineering Associates, Inc. 414 South 17th Street, Suite 107 Ames, Iowa 50010 Phone: (515) 233-0000 FAX: (515) 233-0103	DATE: _____ REVISION: _____ BY: _____ CHECKED: _____ DESIGNED: _____ SHEET UPDATE: 04/22/13
	1 SHEET NO. 1 OF 1		DATE: _____ REVISION: _____ BY: _____ CHECKED: _____ DESIGNED: _____ SHEET UPDATE: 04/22/13

Attachment C: 2012-Excerpt Adaptive Reuse Plan

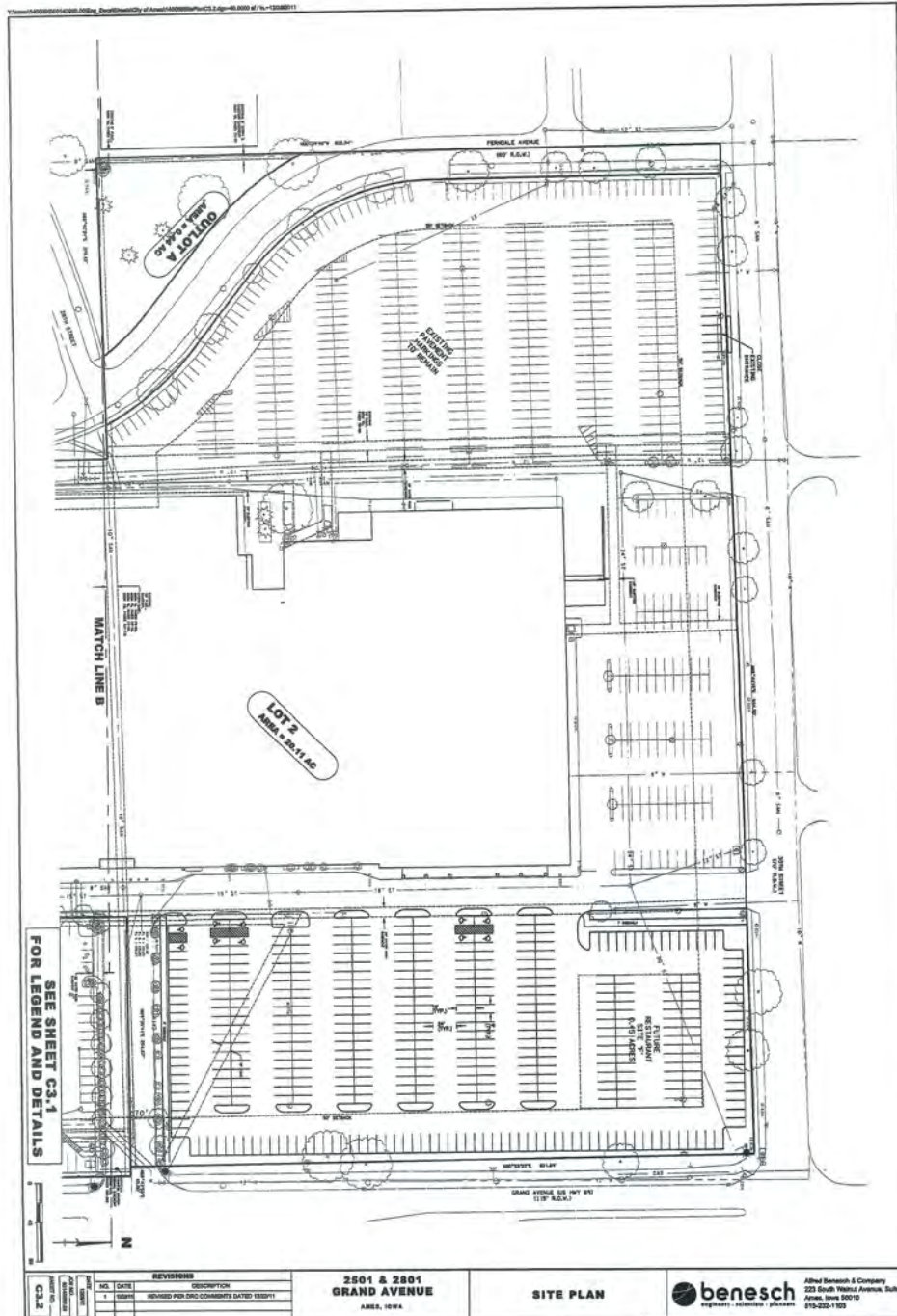

SEE SHEET C3-1
FOR LEGEND AND DETAILS

REVISIONS	
NO.	DATE
1	12/28/11

REVISED FOR DRG COMMENTS DATED 12/28/11

**2501 & 2801
GRAND AVENUE**
AMES, IOWA

SITE PLAN



Alfred Benesch & Company
225 South World Avenue, Suite C
Ames, Iowa 50010
515-223-1155

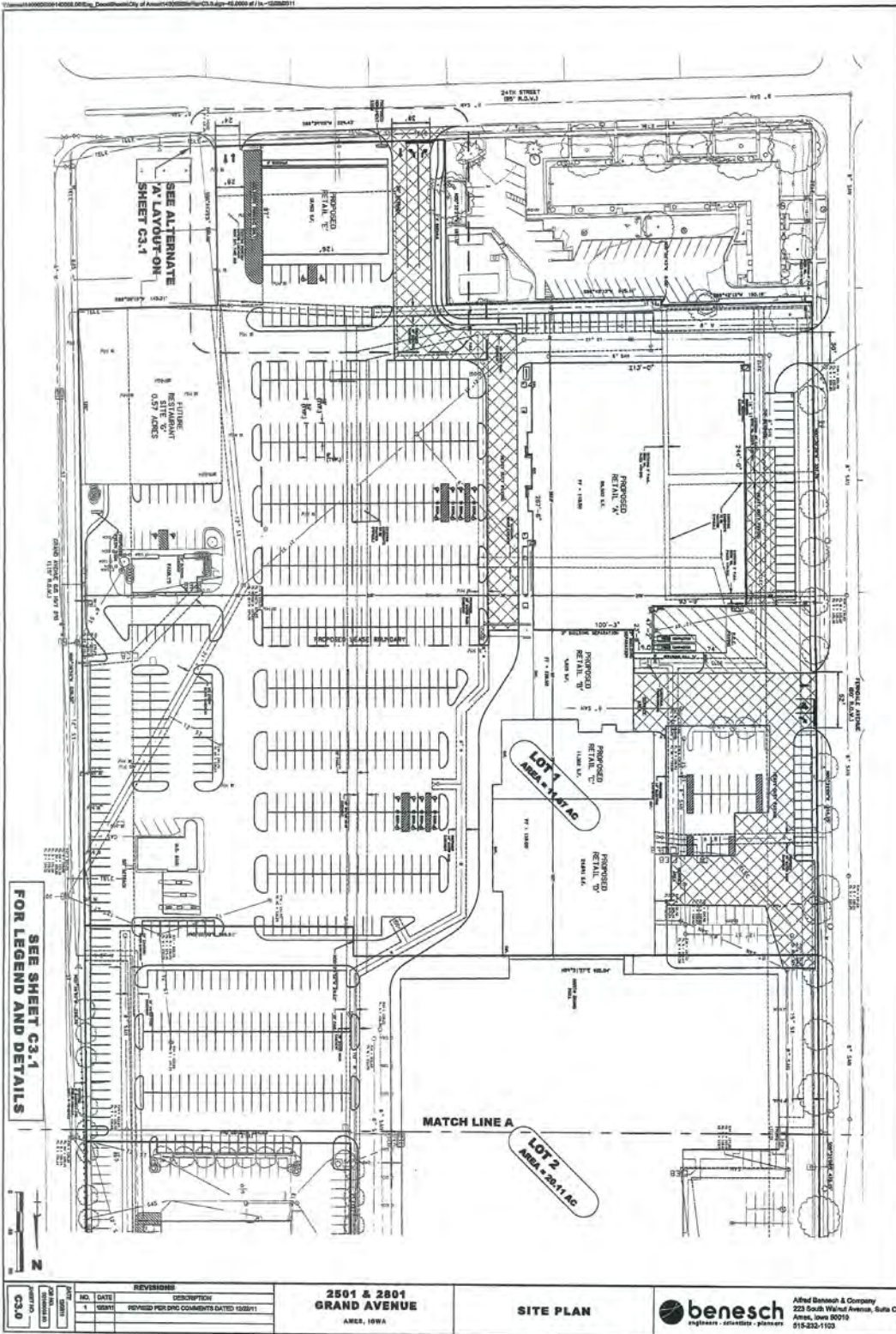

REVISIONS		
NO.	DATE	DESCRIPTION
1	08/21/11	REVISED PER DRC COMMENTS DATED 08/21/11

**2501 & 2801
GRAND AVENUE**
AMES, IOWA

SITE PLAN

benesch
engineers • architects • planners

Alfred Benesch & Company
223 South Walnut Avenue, Suite C
Ames, Iowa 50010
515-252-1122

Attachment D: Adaptive Reuse Plan Criteria

Sec. 29.306. ADAPTIVE REUSE.

(1) **Purpose.** The purpose of these adaptive reuse provisions is to foster the renovation and reuse of structures that have historic, architectural, or economic value to the City and are vacant or at risk of becoming under- utilized, vacant or demolished.

(2) **Qualifying Adaptive Reuses.** Any proposal for the adaptive reuse of a structure or group of contiguous structures, whether or not the proposal involves one or more Nonconforming Uses, Nonconforming Structures, and/or Nonconforming Lots, shall qualify for City Council review if the proposal meets all of the following conditions:

(a) The proposed adaptive reuse must be residential, commercial, or a combination of such uses except if it is located in an industrial zone. If the proposed adaptive reuse is located in an industrial zone, it may be devoted to any use or uses that the City Council finds compatible with the uses permitted in the industrial zone. All adaptive reuses proposed in industrial zones, except industrial uses, require a Special Use Permit.

(b) The structure or group of structures proposed for adaptive reuse must have historic, architectural, or economic value to the City justifying renovation and preservation, as determined by the City Council.

(c) The City Council must determine that the long-term benefits of the proposed adaptive reuse outweigh any negative impact on the neighborhood of the proposed project and on the City, as compared with the alternative of having the structures demolished or remaining vacant or under-utilized.

(d) In all matters relative to the administration of the Adaptive Reuse requirements, the City Council shall obtain a recommendation from the Historic Preservation Commission on all structures that are determined to have architectural or historic value.

(3) **Adaptive Reuse Performance Standards.** If the City Council determines that a proposed project qualifies for consideration as an adaptive reuse, then the City Council may waive some or all of the applicable Zone Development Standards and General Development Standards set forth in Article 4, so long as the project conforms to the following:

(a) The renovation and remodeling of structures for adaptive reuse may not destroy or obscure essential architectural features. In addition, such architectural features must be enhanced to the extent that it is feasible and prudent to do so.

(b) Where landscaping and public space required by Section 29.403 cannot be provided on site, any area on site that is available for landscaping shall be so utilized. When the City grants permission, the owner or operator of the site must also use areas within the public right-of-way and adjacent to the site to satisfy landscaping requirements.

(c) Where necessary parking cannot be provided on site, reasonable provision for parking shall be provided off site.

(4) **Adaptive Reuse Procedures.** Any property in any zone is eligible for adaptive reuse status if it meets the requirements of this Section 29.306, unless otherwise limited by the Use Table for the zone. Submission and review of a project qualified for adaptive reuse shall be in accordance with the procedures set forth in Section 29.1502(4)(c), Major Site Development Plan.

Attachment E: Major Site Development Plan Criteria

- 1. The design of the proposed development shall make adequate provisions for surface and subsurface drainage to limit the rate of increased runoff of surface water to adjacent and downstream property.***

The amount of impervious coverage is only increasing in locations where new sidewalks and parking lot islands are to be constructed. This results in minimum impact to the site. The storm water management plan will remain unchanged and will drain in the same manner as it does today.

- 2. The design of the proposed development shall make adequate provision for connection to water, sanitary sewer, electrical, and other utility lines within the capacity limits of those utility lines.***

The existing utilities were reviewed and found adequate to support the anticipated load of the proposed development. There are no offsite upgrades needed to serve the site for any utility.

- 3. The design of the proposed development shall make adequate provision for fire protection through building placement, acceptable location of flammable materials, and other measures to ensure fire safety.***

The fire inspector has reviewed access and fire truck circulation and found that the needs of the fire department are met for access and circulation. Access into the overall mall site will remain on changed.

- 4. The design of the proposed development shall not increase the danger of erosion, flooding, landslide, or other endangerment to adjoining and surrounding property.***

It is not anticipated that this proposed development will be a danger due to its location on the site. The storm water features will remain unchanged.

- 5. Natural topographic and landscape features of the site shall be incorporated into the development design.***

The developer is working with the existing topography of the site. Landscaping in the form of trees, shrubs and grasses will be incorporated into the design. Front yard landscaping is being incorporated in the site along Grand Avenue and 30th Street. Additional parking lot islands will be added to the parking lot area directly south of this site.

- 6. The design of the interior vehicle and pedestrian circulation shall provide for convenient flow of vehicles and movement of pedestrians and shall prevent hazards to adjacent streets or property.***

Access into the site will come from existing access drive from Grand Avenue and 30th Street. The circulation within will function as a typical commercial parking lot. Sidewalk access will be provided from the building to Grand Avenue. A new sidewalk will be installed from 30th Street along the parking lot drive aisle and from the mall to the building entrance.

The drive through will wrap the building on three sides and provide adequate space for drive aisle stacking without interfering with the flow of traffic within the parking lot. The exit from the drive-through extends beyond the building and is bounded by raised curb on both sides forcing a 90 degree turn into the parking lot to reduce the possibility of driving through and across parking lot aisles and stalls.

- 7. The design of outdoor parking areas, storage yards, trash and dumpster areas, and other exterior features shall be adequately landscaped or screened to minimize potential nuisance and impairment to the use of adjoining property.***

The dumpster area will be screened with as required by code and grasses that will reach five feet at maturity. Other areas of the site are providing adequate landscaping to lessen the impact on adjacent sites.

- 8. The proposed development shall limit entrances and exits upon adjacent streets in order to prevent congestion on adjacent and surrounding streets and in order to provide for safe and orderly vehicle movement.***

All existing access into the development will remain at their existing locations. The proposed drive-through use is designed to allow for queuing on site with minimal interruption to overall circulation of the site.

- 9. Exterior lighting shall relate to the scale and location of the development in order to maintain adequate security, while preventing a nuisance or hardship to adjacent property or streets.***

All lighting will be required to comply with the City's Outdoor Lighting code, Section 29.411. Building lighting must also meet down lighting requirements.

- 10. The proposed development shall ensure that dust and other forms of air pollution, noise disturbances, odor, glare, and other nuisances will be limited to acceptable levels as prescribed in other applicable State and City regulations.***

The proposed development is not expected to generate any nuisances.

11. Site coverage, building scale, setbacks, and open spaces shall be in proportion with the development property and with existing and planned development and structures, in adjacent and surrounding property.

The site is part of an Adaptive Reuse Plan that was originally approved in 2007 and has had subsequent amendments with the most recent being approved in 2012. The combination of existing conditions and new development does include some variances from the standard Planned Regional Commercial requirements but are allowed through the approved Adaptive Reuse Plan if approved by City Council. The 2012 ARP did allow for construction of a restaurant in this area. This proposed multi-tenant building waivers from the 2012 plan only in overall parking ratio of the site, perimeter and parking lot landscaping, but still works well with the overall mall site in design and use.

Attachment F: Proposed Site Plan and Elevations

MAJOR SITE DEVELOPMENT PLAN FOR

NORTH GRAND MALL

SITE F

2801 GRAND AVENUE

AMES, IOWA

THE STATEWIDE URBAN DESIGN AND SPECIFICATIONS (SUDAS 2019) AND THE CURRENT CITY OF AMES SUPPLEMENTAL SPECIFICATIONS SHALL APPLY TO THE CONSTRUCTION WORK ON THIS PROJECT UNLESS NOTED ON THE PLANS OR IN THE CONTRACT.

THIS PROJECT IS COVERED BY THE IOWA DEPARTMENT OF NATURAL RESOURCES NPDES GENERAL PERMIT NO. 2. THE CONTRACTOR SHALL CARRY OUT THE TERMS AND CONDITIONING OF GENERAL PERMIT NO. 2 AND STORM WATER POLLUTION PREVENTION PLAN WHICH IS PART OF THESE CONTRACT DOCUMENTS. REFER TO SECTION 2602 OF THE DOT STANDARD SPECIFICATION FOR ADDITIONAL INFORMATION.

LOCATION MAP

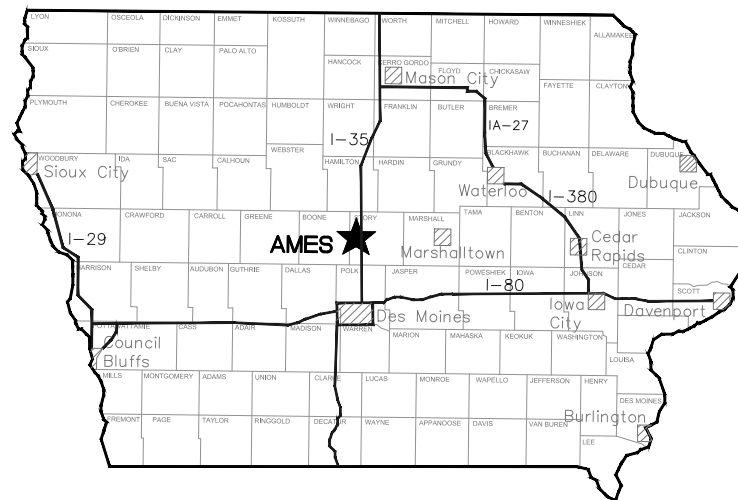
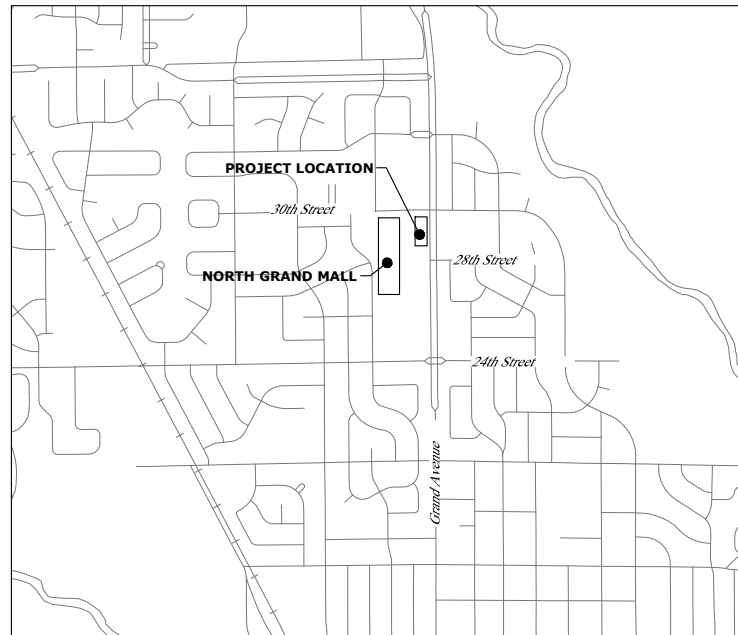

INDEX OF SHEETS	
No.	Description
G1.01	COVER SHEET/ LOCATION MAP/LEGEND
G2.01	DETAILS
C1.01	EXISTING CONDITIONS & REMOVALS
C2.01 - C2.03	SITE LAYOUT & DIMENSION PLAN
C2.04	PAVEMENT JOINTING PLAN
C3.01 - C3.02	SITE GRADING PLAN
C3.03 - C3.04	GRADING DETAIL VIEW
C4.01	SITE UTILITY PLAN (SAN & WATER)
C4.02	SITE UTILITY PLAN (STORM)
C5.01	LANDSCAPING PLAN

LEGEND	
PROPOSED	EXISTING
Concrete Paving	Beehive Intake
Sidewalk	Bollard
Cleanout	Building
	Buried Power
	Bushes
	Cable Pedestal
	Cleanout
	Culvert
	Curb Stop
	Electric Pedestal
	Fence
	Fiber Optic
	Force Main
	Gas Line
	Gas Meter
	Gas Valve
	Hydrant
	Electric Junction Box
	Light Post
	Mailbox
	Manhole
	Overhead Communication
	Overhead Power
	Power Pole
	Property Pin
	Property/Right-Of-Way Line
	Railroad Tracks
	Sanitary Manhole
	Sanitary Sewer
	Sign
	Storm Intakes
	Storm Sewer
	Storm Sewer Manhole
	Stump
	Buried Communication
	Telephone Manhole
	Telephone Pedestal
	Telephone Pole
	Traffic Pole
	Treeline
	Trees
	Water Line
	Water Manhole
	Water Meter
	Water Valve
	Witness Post
	Yard Hydrant

SITE PLAN DATA:

OWNERS/ APPLICANTS
 THRESHOLD NGM LP 51%
 KIRKWOOD APARTMENTS ACQUISITION
 TWO LC 15%
 NGM OWNERSHIP GROUP LC 34%
 C/O BRENT HAVERKAMP
 5820 LINCOLN WAY
 SUITE 101
 AMES, IA 50014

PREPARED BY
 SCOTT WILLIAMS, P.E.
 FOX ENGINEERING
 414 S 17TH STREET, SUITE 107
 AMES, IA 50010
 PH (515)233-0000

SITE ADDRESS
 2801 GRAND AVENUE

LEGAL DESCRIPTION
 STREETS OF NORTH GRAND, LOT 2, AMES,
 STORY COUNTY, IOWA

LOT AREA
 20.11 AC (876,163 S.F.)

SETBACKS
 FRONT: 50'
 SIDE: 0'
 REAR: 0'
 LOT LINE ABUTTING AN R-ZONED LOT: 50'

ZONING
 PRC

IMPERVIOUS AREA CREATED OR REPLACED
 PAVEMENT REMOVAL 49,042 S.F.
 NEW BUILDING 7,166 S.F.
 NEW SIDEWALK / PATIO 7,238 S.F.
 NEW PAVEMENT 28,284 S.F.
 42,688 S.F. (0.98 AC)

PARKING (NE LOT)

EXISTING	STANDARD:	372
	COMPACT:	46
	ACCESSIBLE:	10
		428

PARKING (OVERALL MALL SITE)

PROPOSED	STANDARD:	290
	COMPACT:	42
	ACCESSIBLE:	14
		346

EXISTING	PLAT 2	LOT 2	LOT 3	TOTAL
STANDARD	590	1,115	113	1,818
COMPACT	12	46	0	58
ACCESSIBLE	20	10	4	34
				TOTAL 1,910

PROPOSED	PLAT 2	LOT 2	LOT 3	TOTAL
STANDARD	613	1,020	113	1,746
COMPACT	12	42	0	54
ACCESSIBLE	22	14	4	40
				TOTAL 1,840

ENGINEER:
FOX ENGINEERING
 414 SOUTH 17TH STREET, SUITE 107
 AMES, IOWA 50010
 PHONE: (515) 233-0000
 FAX: (515) 233-0103



I hereby certify that this engineering document was prepared by me or under my direct personal supervision and that I am a duly licensed Professional Engineer under the laws of the State of Iowa.

Scott A. Williams 8/22/19
 SCOTT A. WILLIAMS DATE
 License number 13310

My license renewal date is December 31, 2020.
 Pages or sheets covered by this set: ALL

SITE NOTE:
 ALL CONSTRUCTION MATERIALS, DUMPSTERS, DETACHED TRAILERS OR SIMILAR ITEMS ARE PROHIBITED ON PUBLIC STREETS OR WITHIN THE PUBLIC RIGHT-OF-WAY.

GENERAL NOTE: ALL UTILITIES ARE ONLY GENERALLY LOCATED. CONTRACTOR IS RESPONSIBLE FOR LOCATING AND EXPOSING ALL UTILITIES THAT MAY INTERFERE WITH CONSTRUCTION BEFORE CONSTRUCTION BEGINS.

DRAWING FILENAME
 K:\1901\5000\5459-188 North Grand Mall-Site F\Drawings\General\5459-188_Cover & Details.dwg
 PLOT STYLE TABLE
 LAYER MGR NAME
 FOX015.ctb
 LAYOUT NAME
 G1.01

NORTH GRAND MALL

DATE	REVISION	BY	DATE
07/02/19	AS PER DISCUSSION DATED 06/07/19	SAW	
08/22/19	REVISED PER CITY URBAN DESIGN COMMENTS	SRS	
		CHECKED:	LAST UPDATE: 08/22/19

FOX Engineering Associates, Inc.
 414 South 17th Street, Suite 107
 Ames, Iowa 50010
 Phone: (515) 233-0000
 FAX: (515) 233-0103

FOX engineering

COVER SHEET/ LOCATION MAP/LEGEND
 NORTH GRAND MALL
 SITE F
 2801 GRAND AVENUE
 AMES, IOWA

PROJECT NO.
 5459-188

SHEET
 G1.01

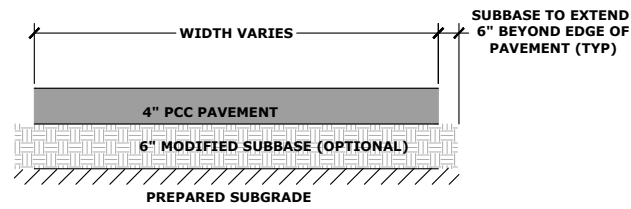

1 TYPICAL SIDEWALK SECTION
NTS

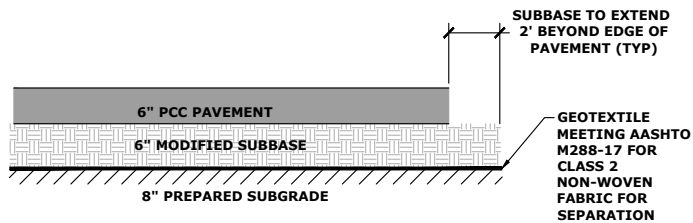

2 PCC PAVEMENT SECTION
NTS

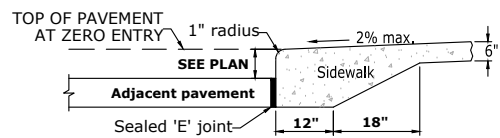

3 THICKENED EDGE SIDEWALK DETAIL
NOT TO SCALE

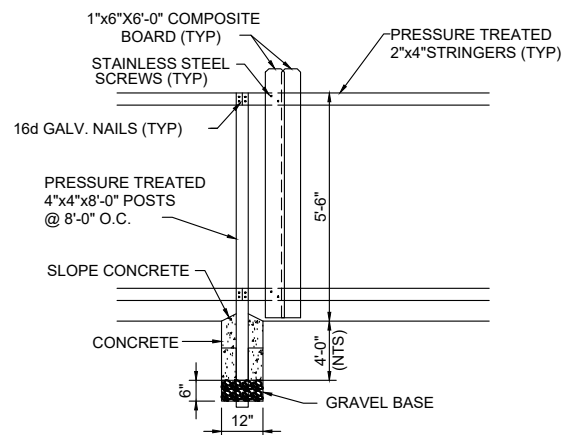
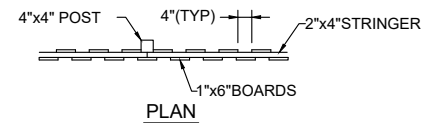
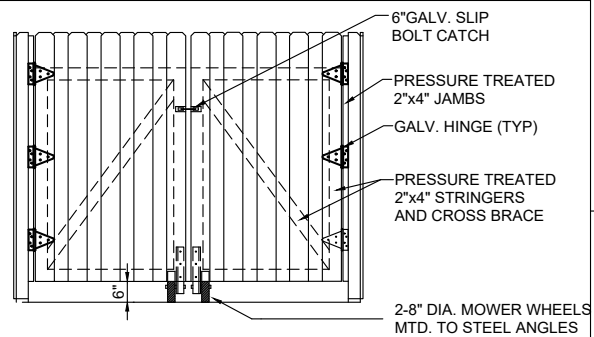

4 DUMPSTER ENCLOSURE DETAIL
NOT TO SCALE

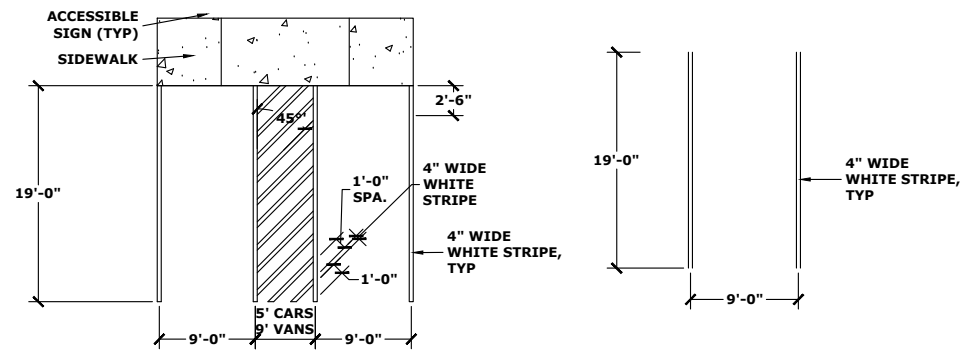

TYPICAL ACCESSIBLE PARKING SPACES

STRIPING PATTERN FOR SINGLE PARKING STALL

5 TYPICAL PAVEMENT MARKING DETAILS
NTS

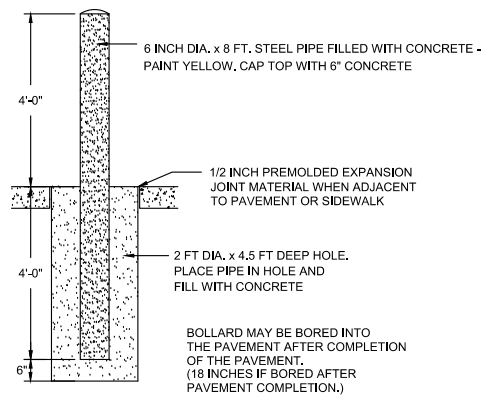

6 TYPICAL BOLLARD DETAIL
NTS

SIGNAGE NOTES:

1. VERIFY THAT SIGNAGE PROVIDED COMPLIES WITH STATE AND LOCAL CODES.
2. VAN ACCESSIBLE PLACARD SHALL BE PLACED IN FRONT OF VAN ACCESSIBLE STALLS.
3. FIELD VERIFY LOCATIONS OF SIGNS.

OTHER SIGNS MAY BE APPROVED BY THE ENGINEER.

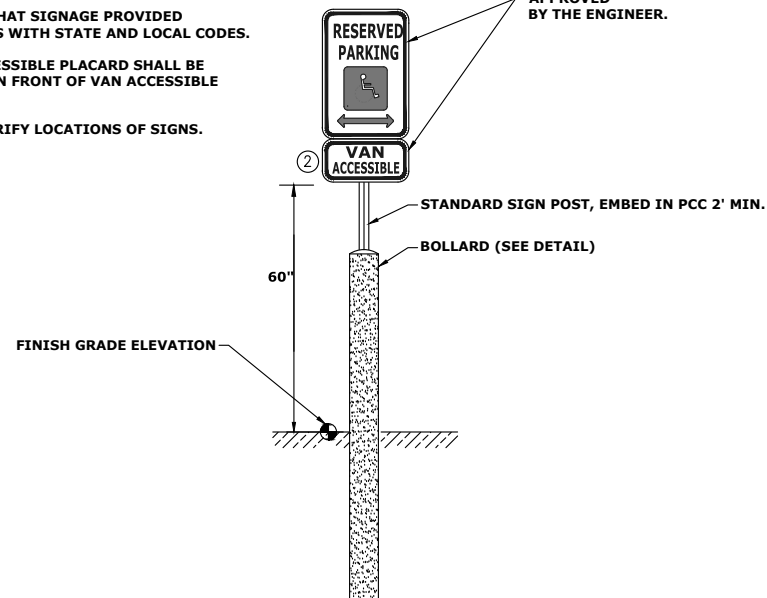

7 HANDICAP SIGN POST DETAIL
NOT TO SCALE

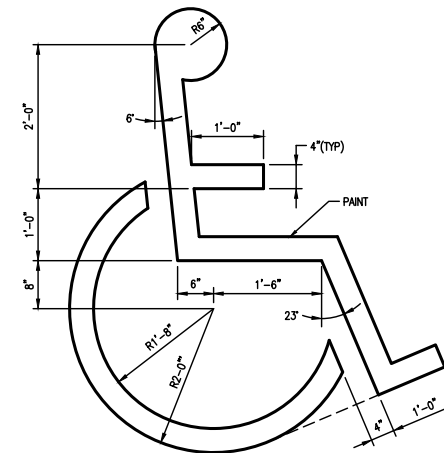

NOTE: SYMBOL TO BE CENTERED IN PARKING SPACE AND ORIENTED AS ILLUSTRATED ON PLANS.

8 HANDICAPPED PARKING SYMBOL
NOT TO SCALE



9 MUTCD SIGN R7-8 (HANDICAP PARKING)
NOT TO SCALE



10 MUTCD SIGN R7-8a (VAN ACCESSIBLE)
NOT TO SCALE

DRAWING FILENAME: K:\p001\5000\5459-18B North Grand Mall-Site F\Drawings\General\5459-18B_Cover & Details.dwg
 PLOT STYLE TABLE: FoxGrayScale.ctb
 LAYER MGR NAME: GZ.01
 LAYOUT NAME: GZ.01

DATE	BY	DESIGNED	DRAWN	CHECKED	LAST UPDATE
07/19	SAW		SRS		08/21/19

REVISION	DATE

FOX Engineering Associates, Inc.
 414 South 17th Street, Suite 107
 Ames, Iowa 50010
 Phone: (515) 233-0000
 FAX: (515) 233-0103

DETAILS
 NORTH GRAND MALL
 SITE F
 2801 GRAND AVENUE
 AMES, IOWA

PROJECT NO.
 5459-18B
 SHEET
 G2.01

DRAWING FILENAME: K:\proj\5000\5459-188 North Grand Mall- Site F Drawings\Civil\5459-188 IMPROVEMENTS PLAN.dwg
 PLOT STYLE TABLE: FoxGrayScale.ctb
 LAYER MGR NAME: CL01

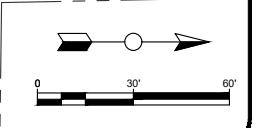
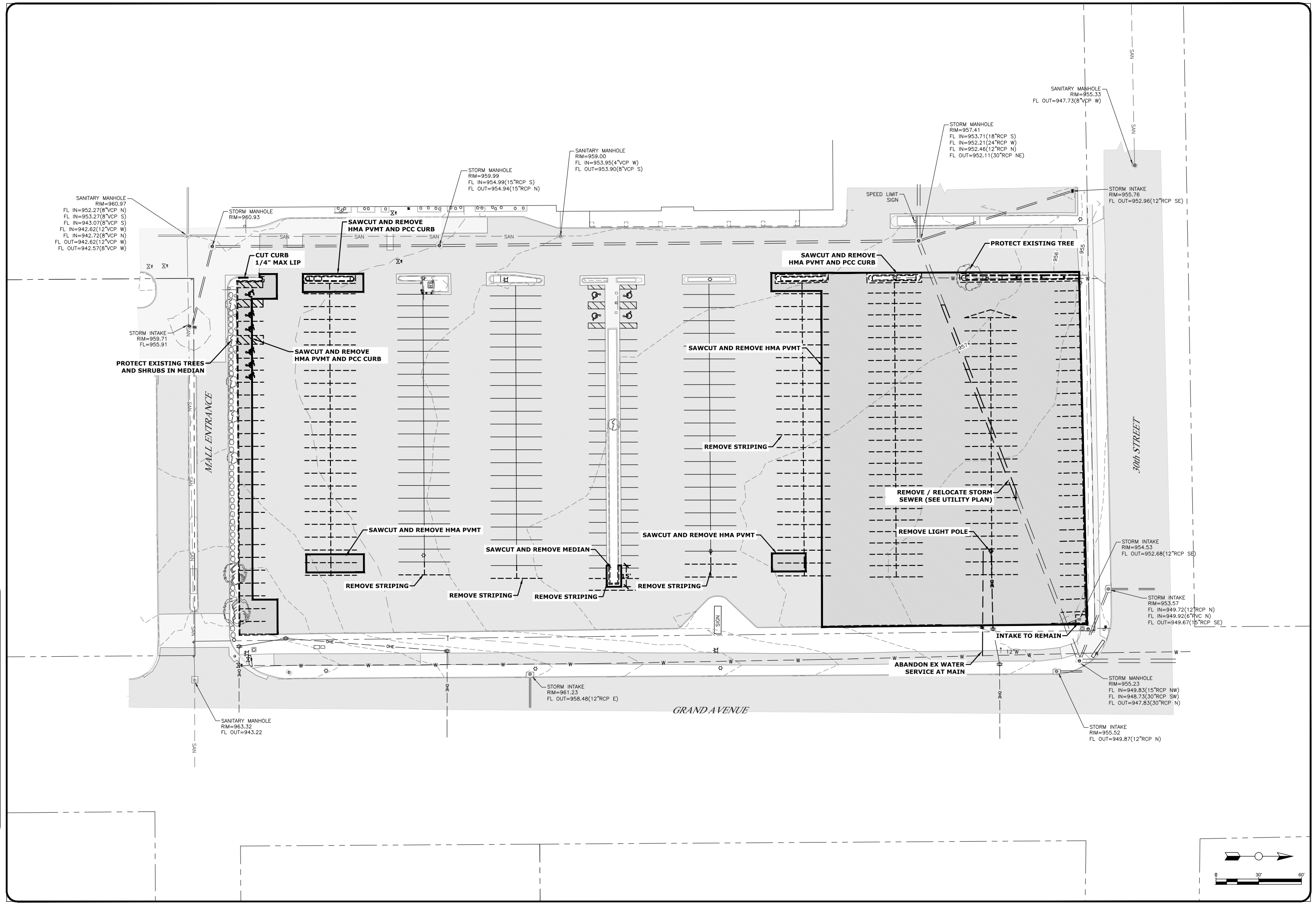

DATE	BY	REVISION
08/27/19	SAW	DESIGNED
08/19	SRS	DRAWN
08/19		CHECKED
08/27/19		LAST UPDATE:

FOX Engineering Associates, Inc.
 414 South 17th Street, Suite 107
 Ames, Iowa 50010
 Phone: (515) 233-0000
 FAX: (515) 233-0103

FOX Engineering

EXISTING CONDITIONS & REMOVALS
 NORTH GRAND MALL
 LOT F
 2801 GRAND AVENUE
 AMES, IA

PROJECT NO.
 5459-188

SHEET
C1.01

DRAWING FILENAME: K:\proj\5000\5459-18B_North_Grand_Mall_Site_F\Drawings\Civil\5459-18B_IMPROVEMENTS_PLAN.dwg
 PLOT STYLE TABLE: FoxGray.ctb
 LAYER MGR NAME: FoxGrayScale.ctb
 LAYOUT NAME: C2.01

NORTH GRAND MALL

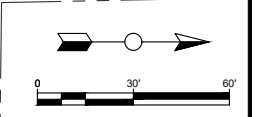
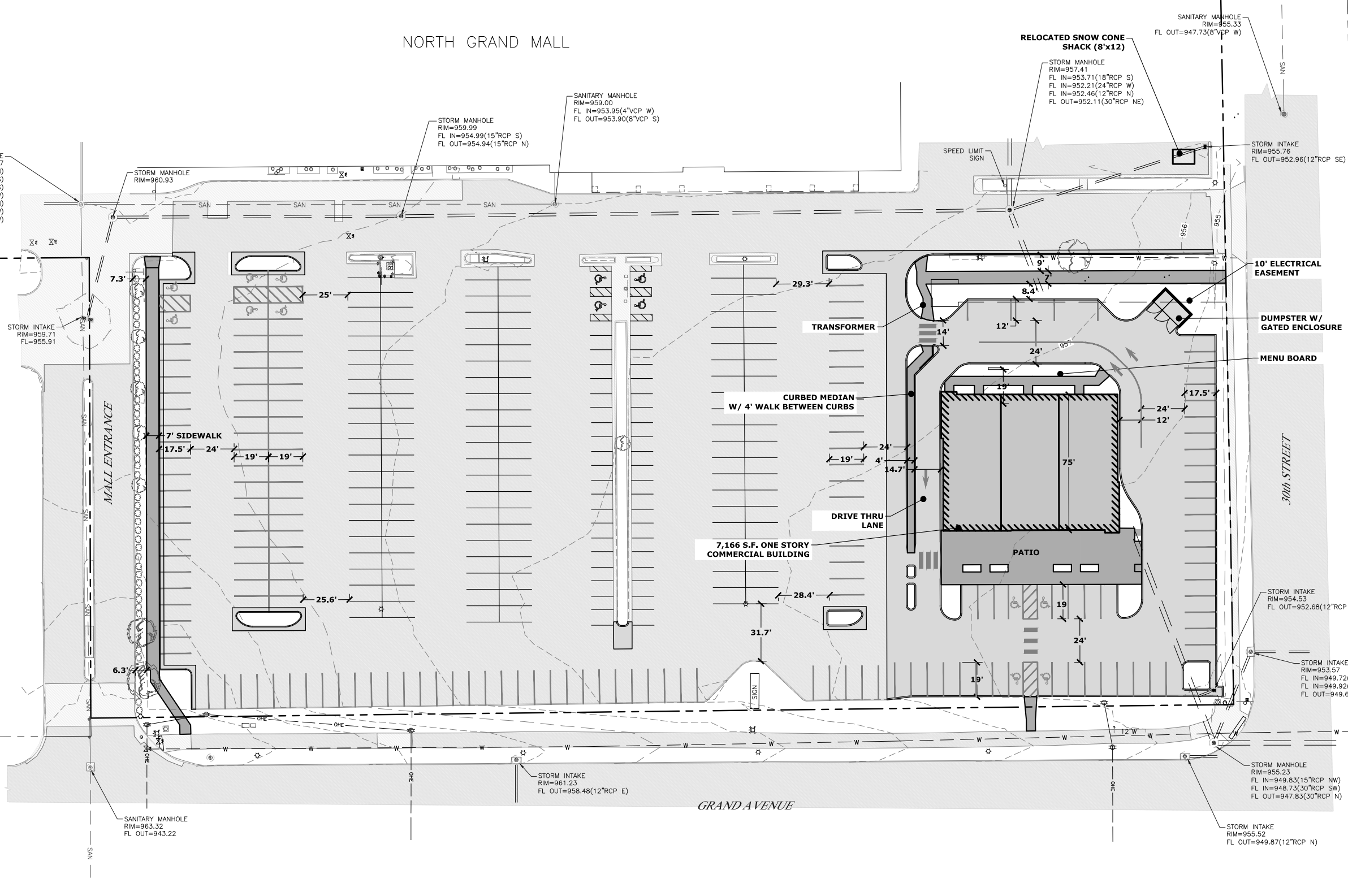

DATE	BY	REVISION
08/27/19	SAW	REVISED LAYOUT BASED ON P&Z COMMENTS
08/19	SRS	
08/19	SRS	
08/27/19		LAST UPDATE:

FOX Engineering Associates, Inc.
 414 South 17th Street, Suite 107
 Ames, Iowa 50010
 Phone: (515) 233-0000
 FAX: (515) 233-0103

FOX Engineering

OVERALL SITE LAYOUT & DIMENSION PLAN
 NORTH GRAND MALL
 LOT F
 2801 GRAND AVENUE
 AMES, IA

PROJECT NO.
5459-18B

SHEET
C2.01

DRAWING FILENAME
 K:\proj\5000\5459-188_North_Grand_Mall_Site_F\Drawings\Civil\5459-188_IMPROVEMENTS_PLAN.dwg
 PLOT STYLE TABLE
 FoxGrayScale.ctb
 LAYER MNGR NAME
 C2.02
 LAYOUT NAME
 C2.02

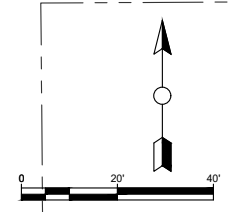
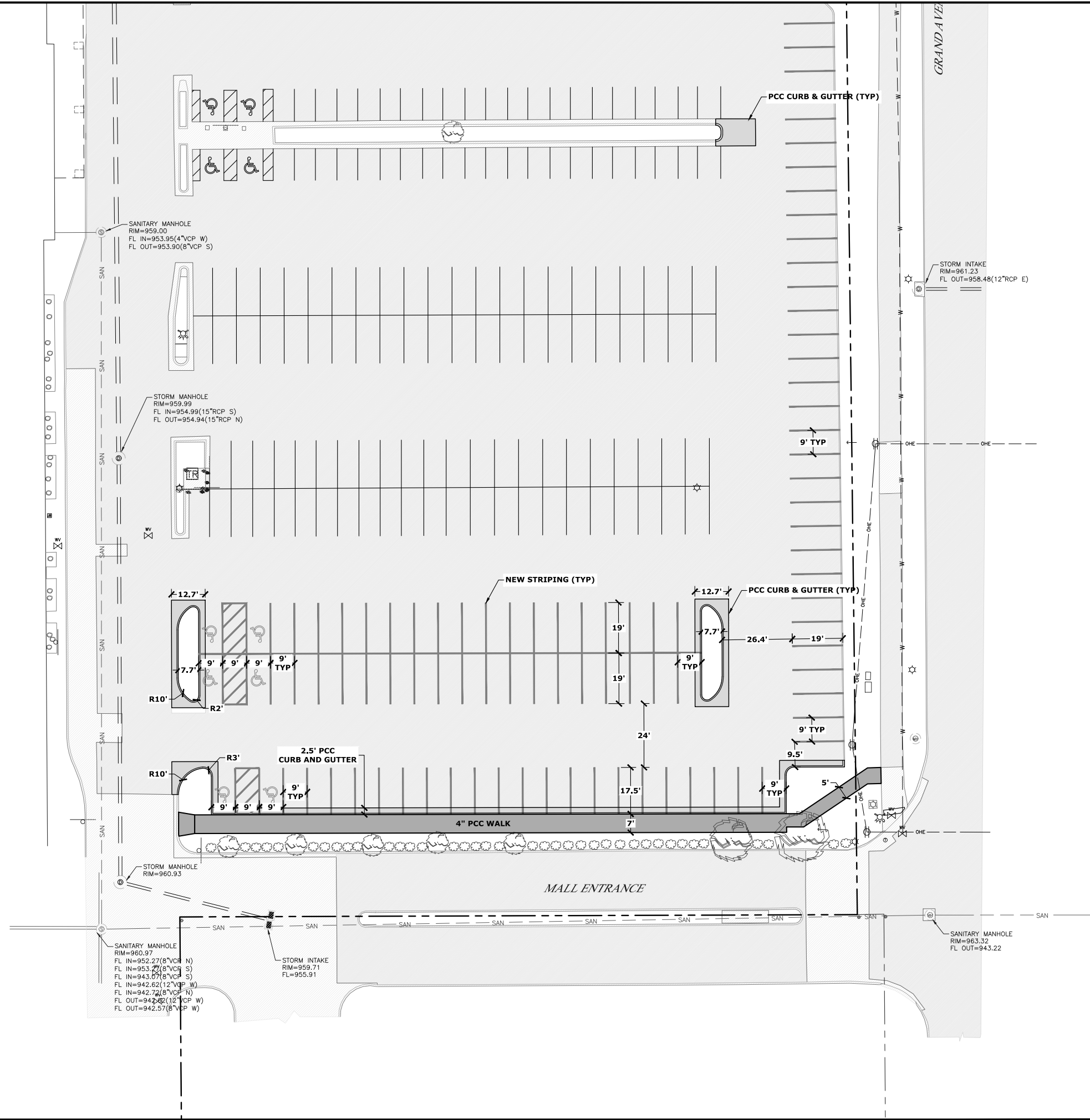

DATE	REVISION	BY	DATE
		RESIGNED: SAW	08/19
		DRAWN: SRS	08/19
		CHECKED:	
		LAST UPDATE:	08/21/19

FOX Engineering Associates, Inc.
 414 South 17th Street, Suite 107
 Ames, Iowa 50010
 Phone: (515) 233-0000
 FAX: (515) 233-0103

FOX Engineering

SITE LAYOUT & DIMENSION PLAN (SOUTH)
 NORTH GRAND MALL
 LOT F
 2801 GRAND AVENUE
 AMES, IA

PROJECT NO.
 5459-188
 SHEET
C2.02

K:\proj\5000\5459-188_North_Grand_Mall_Site_F\Drawings\Civil\5459-188_IMPROVEMENTS_PLAN.dwg
 DRAWING FILENAME
 PLOT STYLE TABLE
 LAYER MNGR NAME
 FoxGrayScale.ctb
 LAYOUT NAME
 C2.04

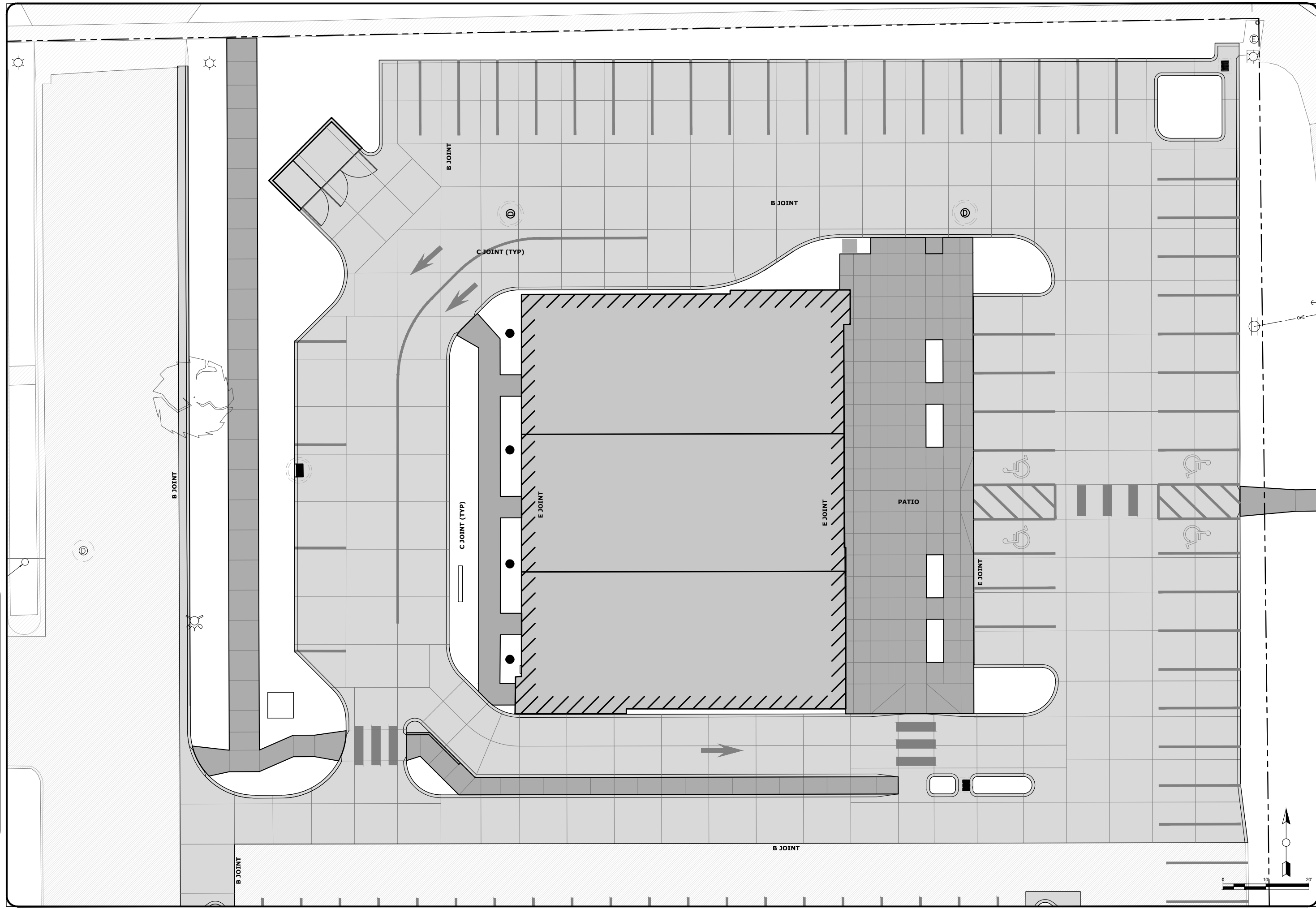

DATE	REVISION	DESIGNED BY	DATE
08/27/19	REVISED LAYOUT BASED ON P&Z COMMENTS	SAW	08/19
		SRS	08/19
		CHECKED	
		LAST UPDATE:	08/27/19

FOX Engineering Associates, Inc.
 414 South 17th Street, Suite 107
 Ames, Iowa 50010
 Phone: (515) 233-0000
 FAX: (515) 233-0103

FOX Engineering

PAVEMENT JOINTING PLAN
 NORTH GRAND MALL
 LOT F
 2801 GRAND AVENUE
 AMES, IA

PROJECT NO.
 5459-188

SHEET
 C2.04

K:\proj\5000\5459-188 North Grand Mall-Site F\Drawings\Civil\5459-188_IMPROVEMENTS PLAN.dwg
 DRAWING FILENAME
 PROJECT NO. 5459-188
 PLOT STYLE TABLE FoxGrayScale.ctb
 LAYER MNGR NAME
 LAYOUT NAME C3.01

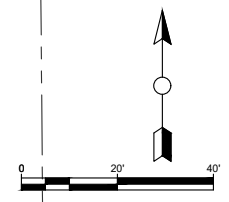
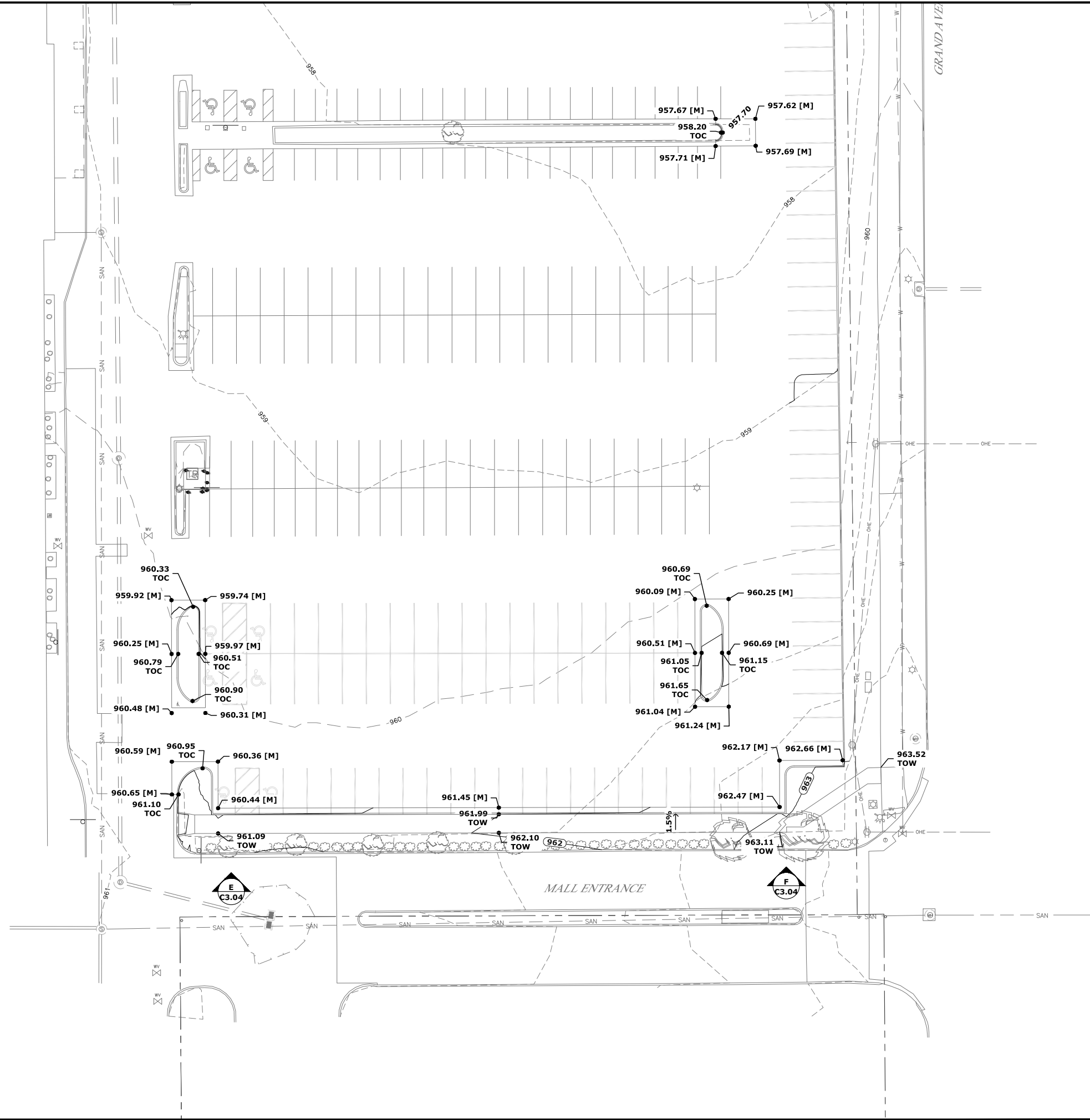

DATE	BY	REVISION
08/21/19	SAW	DESIGNED
08/19	SRS	DRAWN
08/19		CHECKED
08/21/19		LAST UPDATE

PROJECT NO.
5459-188

SHEET
C3.01

FOX Engineering
 FOX Engineering Associates, Inc.
 414 South 17th Street, Suite 107
 Ames, Iowa 50010
 Phone: (515) 233-0000
 FAX: (515) 233-0103

SITE GRADING PLAN (SOUTH)
 NORTH GRAND MALL
 LOT F
 2801 GRAND AVENUE
 AMES, IA

DRAWING FILENAME: K:\proj\5000\5459-188_North_Grand_Mall_Site_F\Drawings\Civil\5459-188_IMPROVEMENTS_PLAN.dwg
 PLOT STYLE TABLE: FoxGrayScale.ctb
 LAYER: MNGR NAME
 LAYOUT NAME: C3.03

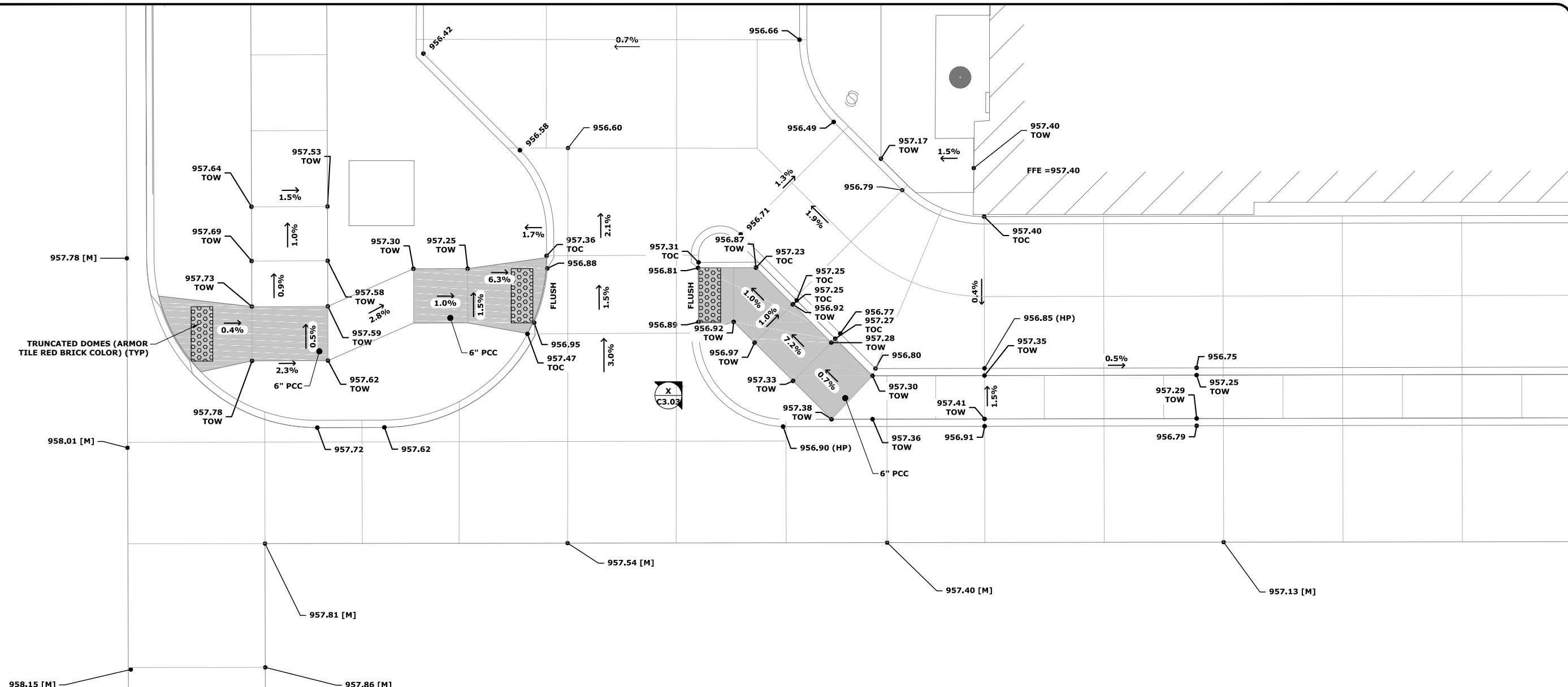

A
 C3.03 **GRADING DETAIL VIEW**
 WEST EXIT

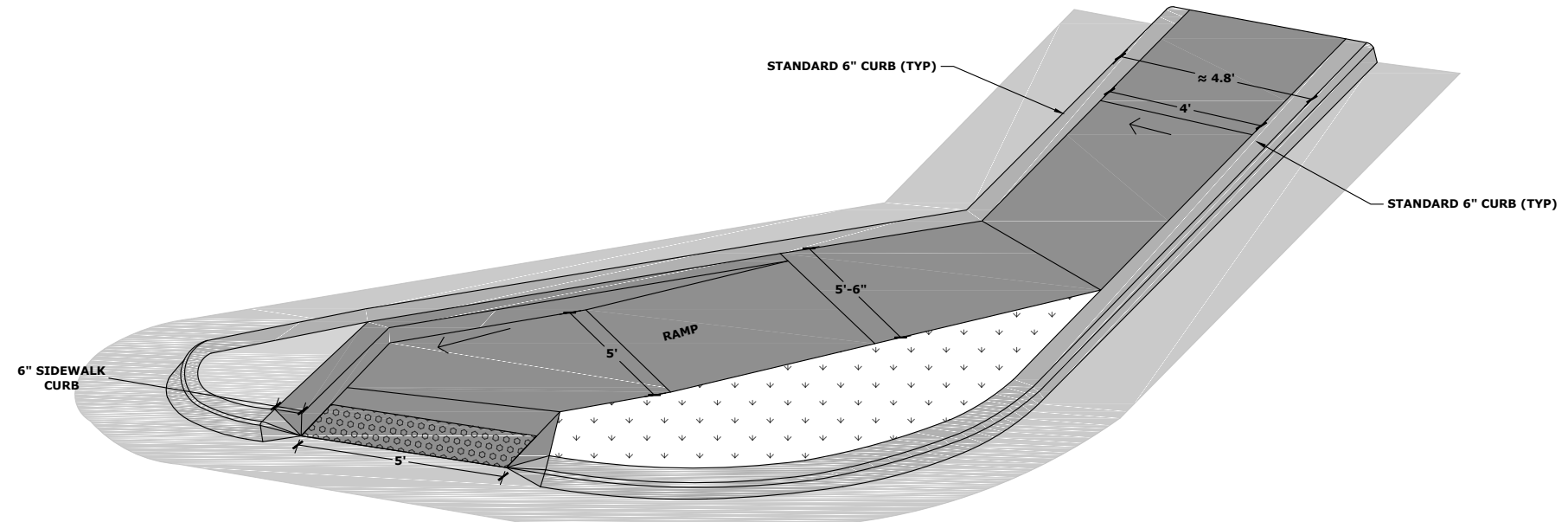

X
 C3.03 **OBLIQUE VIEW**
 RAMP TO MEDIAN SIDEWALK

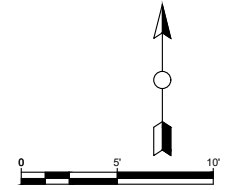

DATE	BY	REVISION
08/21/19	SAW	DESIGNED
08/19	SRS	DRAWN
08/19	SRS	CHECKED
08/21/19		LAST UPDATE:

DATE	BY	REVISION
08/21/19	SAW	REVISED LAYOUT BASED ON P&E COMMENTS

FOX Engineering Associates, Inc.
 414 South 17th Street, Suite 107
 Ames, Iowa 50010
 Phone: (515) 233-0000
 FAX: (515) 233-0103



GRADING DETAIL VIEW
 NORTH GRAND MALL
 LOT F
 2801 GRAND AVENUE
 AMES, IA

PROJECT NO.
 5459-188
 SHEET
C3.03

DRAWING FILENAME K:\proj\5000\5459-188 North Grand Mall Site\Drawings\Civil\5459-188 IMPROVEMENTS PLAN.dwg
 PLOT STYLE TABLE FoxGrayScale.ctb
 LAYER MNGR NAME C3.04
 LAYOUT NAME C3.04

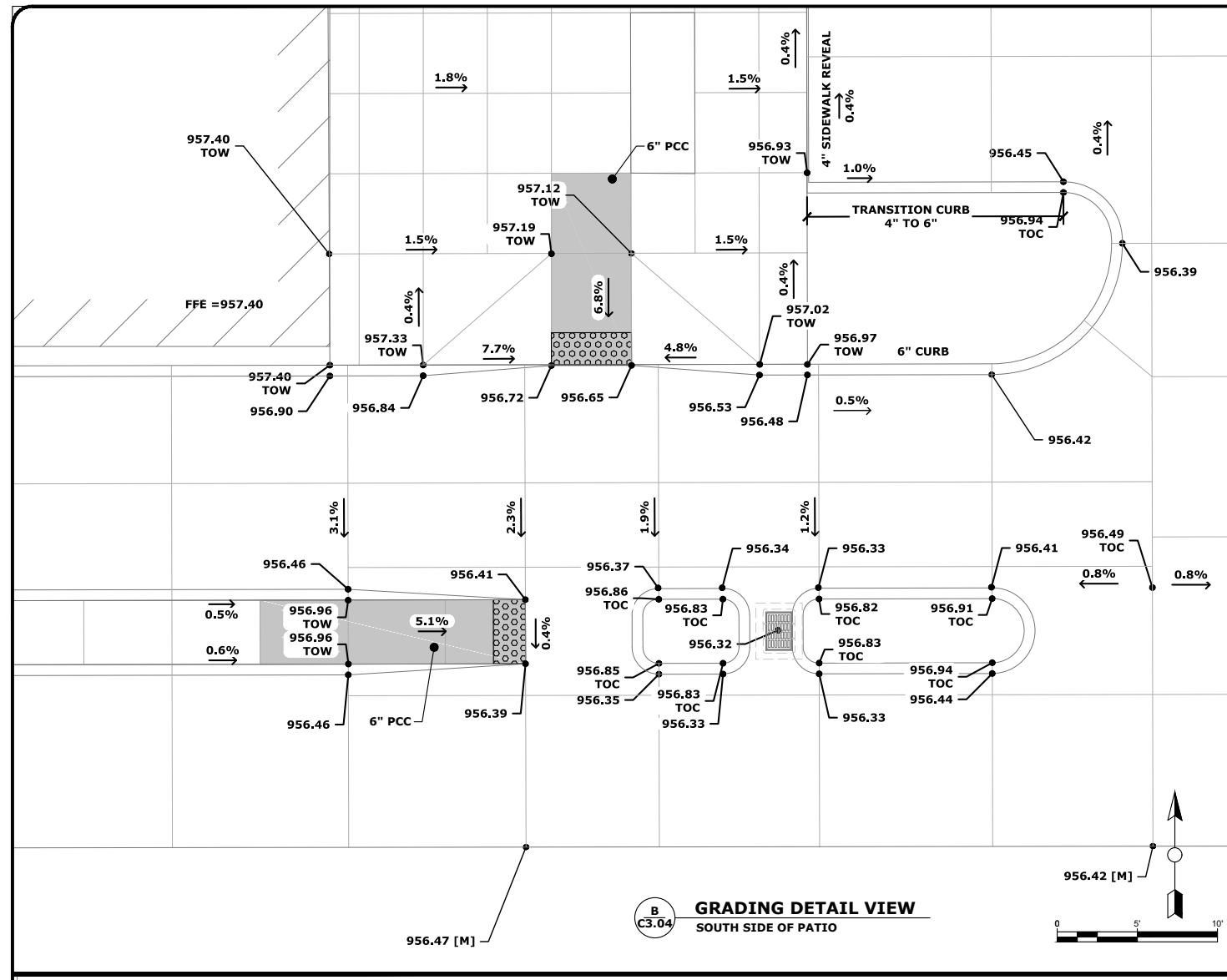

B
C3.04 **GRADING DETAIL VIEW**
SOUTH SIDE OF PATIO

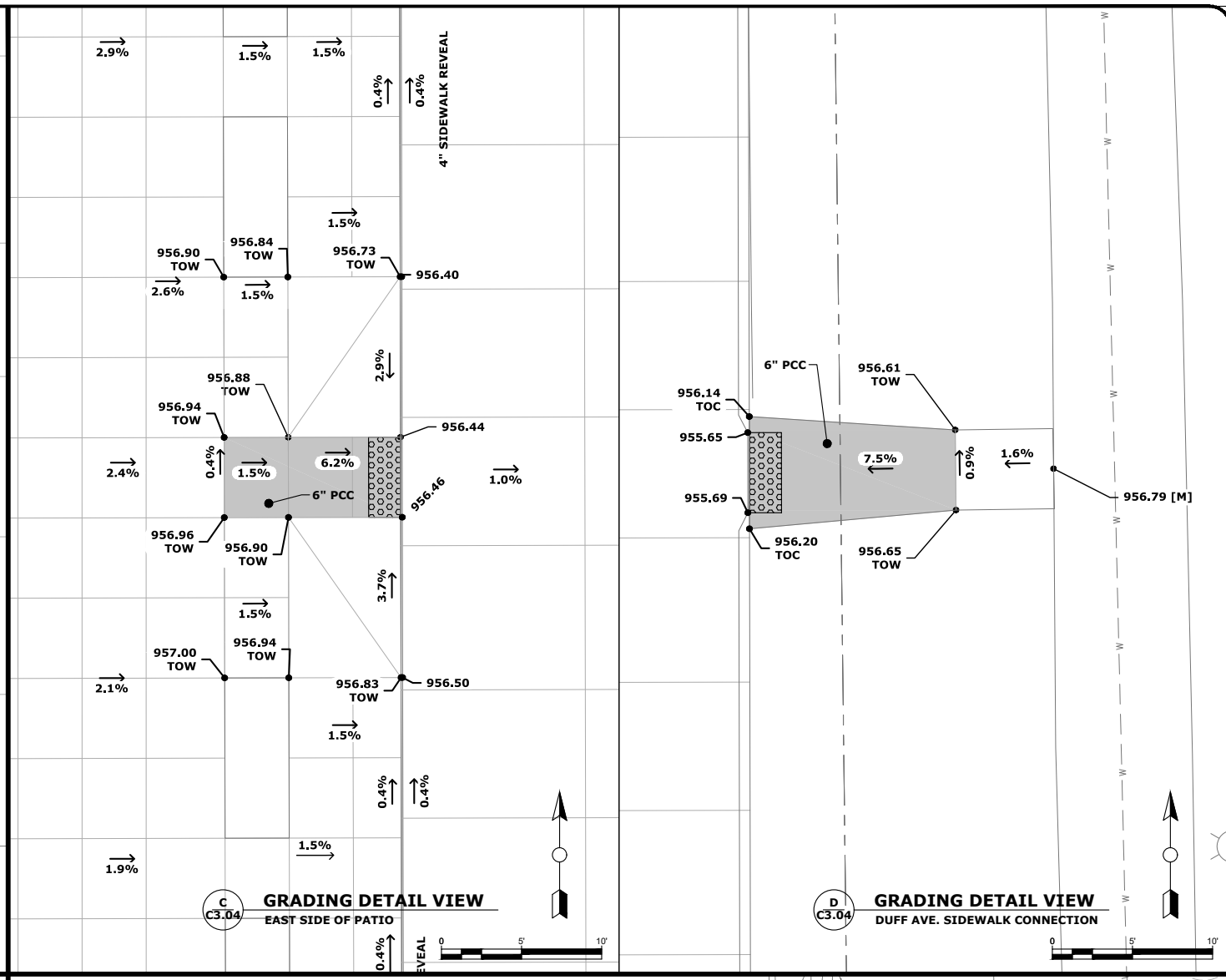
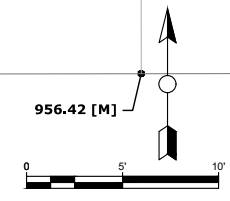

C
C3.04 **GRADING DETAIL VIEW**
EAST SIDE OF PATIO

D
C3.04 **GRADING DETAIL VIEW**
DUFF AVE. SIDEWALK CONNECTION

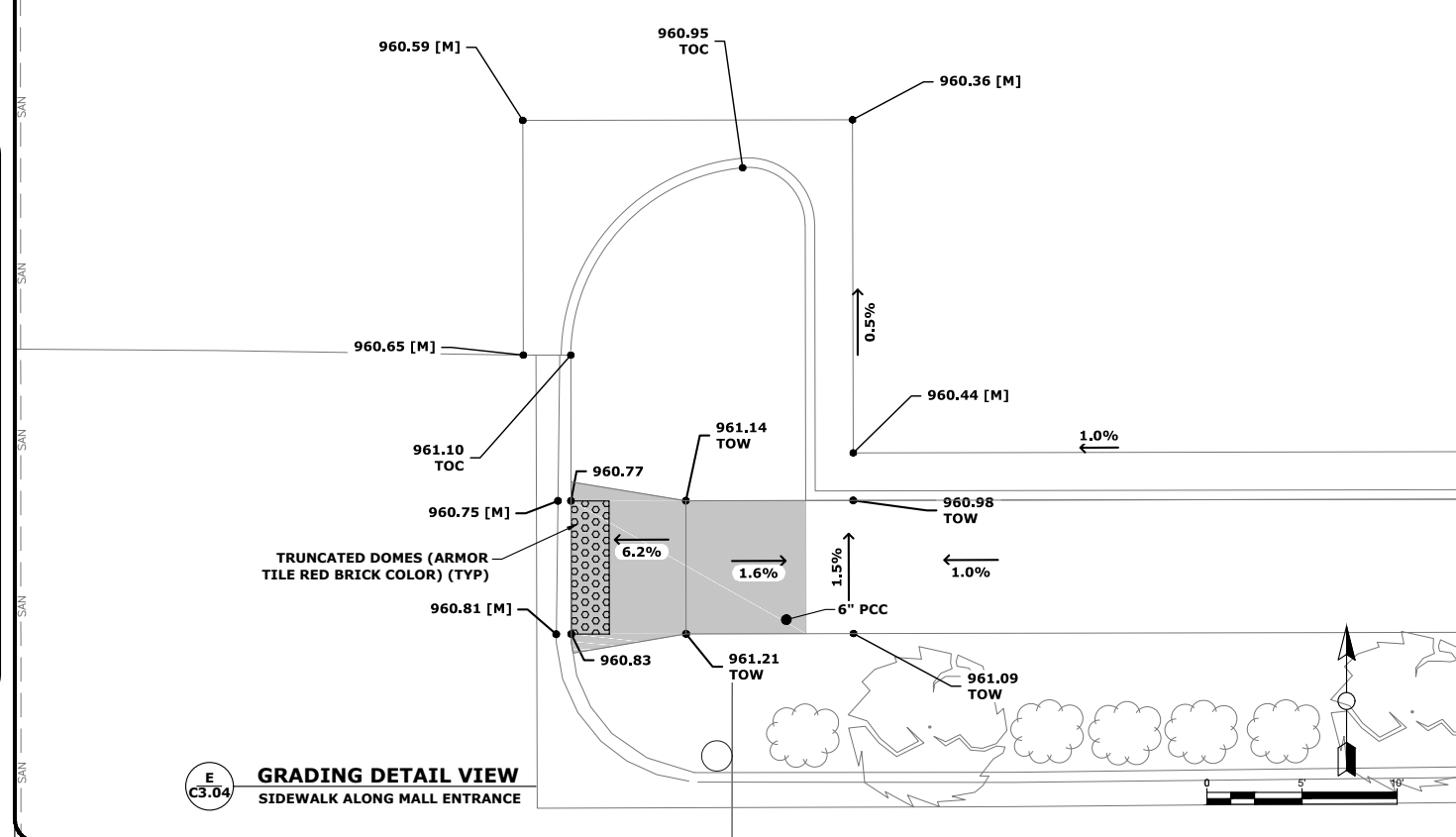
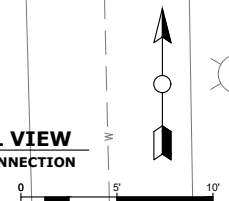
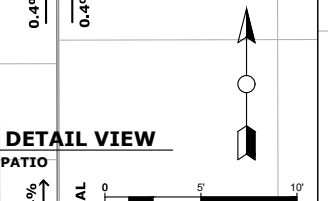

E
C3.04 **GRADING DETAIL VIEW**
SIDEWALK ALONG MALL ENTRANCE

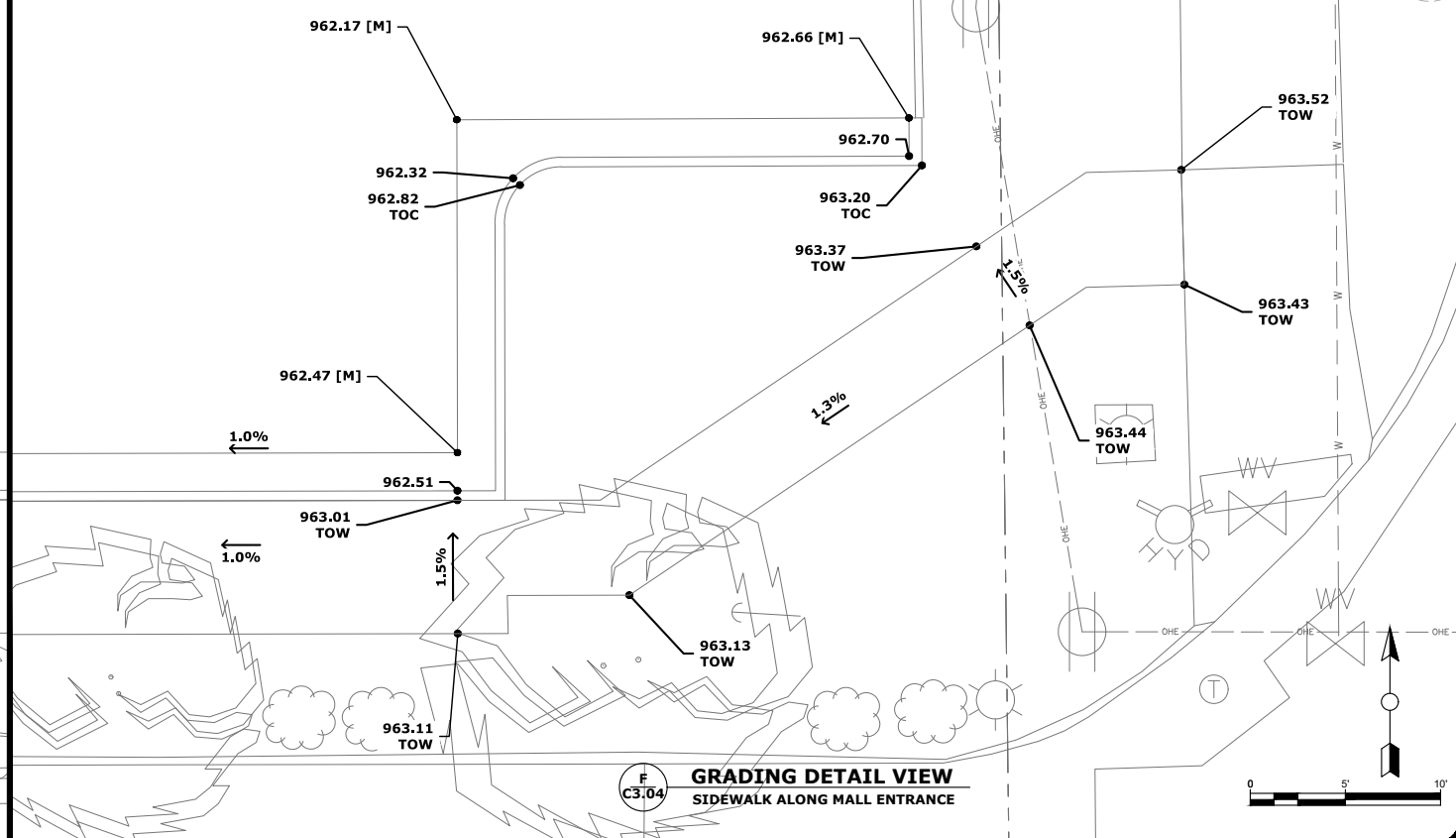
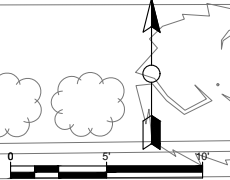

F
C3.04 **GRADING DETAIL VIEW**
SIDEWALK ALONG MALL ENTRANCE

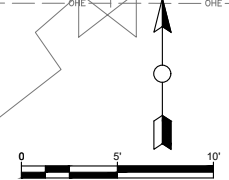

DATE	BY	REVISION
08/21/19	SAW	REVISOR LAYOUT BASED ON R&Z COMMENTS
08/19	SRS	DRAWN
08/19	SRS	CHECKED
08/21/19		LAST UPDATE:

FOX Engineering Associates, Inc.
 414 South 17th Street, Suite 107
 Ames, Iowa 50010
 Phone: (515) 233-0000
 FAX: (515) 233-0103

FOX Engineering

GRADING DETAIL VIEW
 NORTH GRAND MALL
 LOT F
 2801 GRAND AVENUE
 AMES, IA

PROJECT NO.
5459-188

SHEET
C3.04

DRAWING FILENAME: K:\proj\5000\5459-18B_North_Grand_Mall_Site_F\Drawings\Civil\5459-18B_IMPROVEMENTS_PLAN.dwg
 PLOT STYLE TABLE: FoxGrayScale.ctb
 LAYER MGR NAME: C4.01

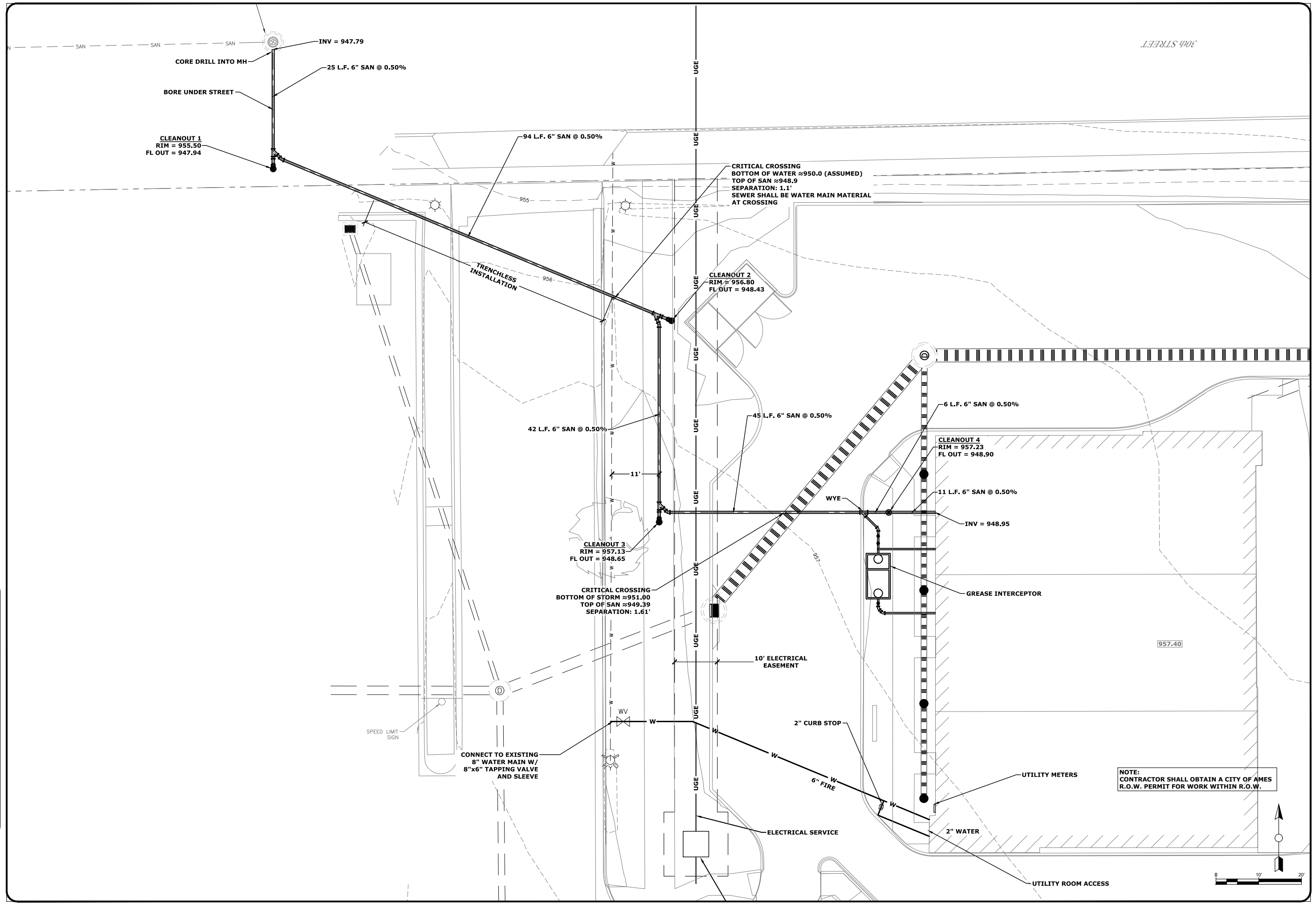

NOTE:
 CONTRACTOR SHALL OBTAIN A CITY OF AMES
 R.O.W. PERMIT FOR WORK WITHIN R.O.W.

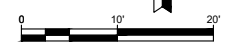

DATE	BY	REVISION
08/27/19	SAW	REVISED LAYOUT BASED ON P&Z COMMENTS
08/19	SRS	
08/19	SRS	
08/27/19		LAST UPDATE:

FOX Engineering Associates, Inc.
 414 South 17th Street, Suite 107
 Ames, Iowa 50010
 Phone: (515) 233-0000
 FAX: (515) 233-0103

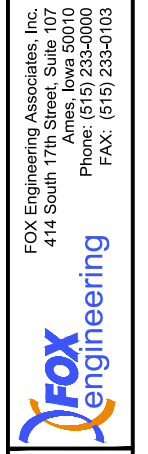

SITE UTILITY PLAN (SAN & WATER)
 NORTH GRAND MALL
 LOT F
 2801 GRAND AVENUE
 AMES, IA

PROJECT NO.
 5459-18B

SHEET
 C4.01

K:\proj\5000\5459-188_North_Grand_Mall_Site_F\Drawings\Civil\5459-188_IMPROVEMENTS_PLAN.dwg
 DRAWING FILENAME
 PLOT STYLE TABLE
 FoxGrayScale.ctb
 LAYER MNGR NAME
 C4.02

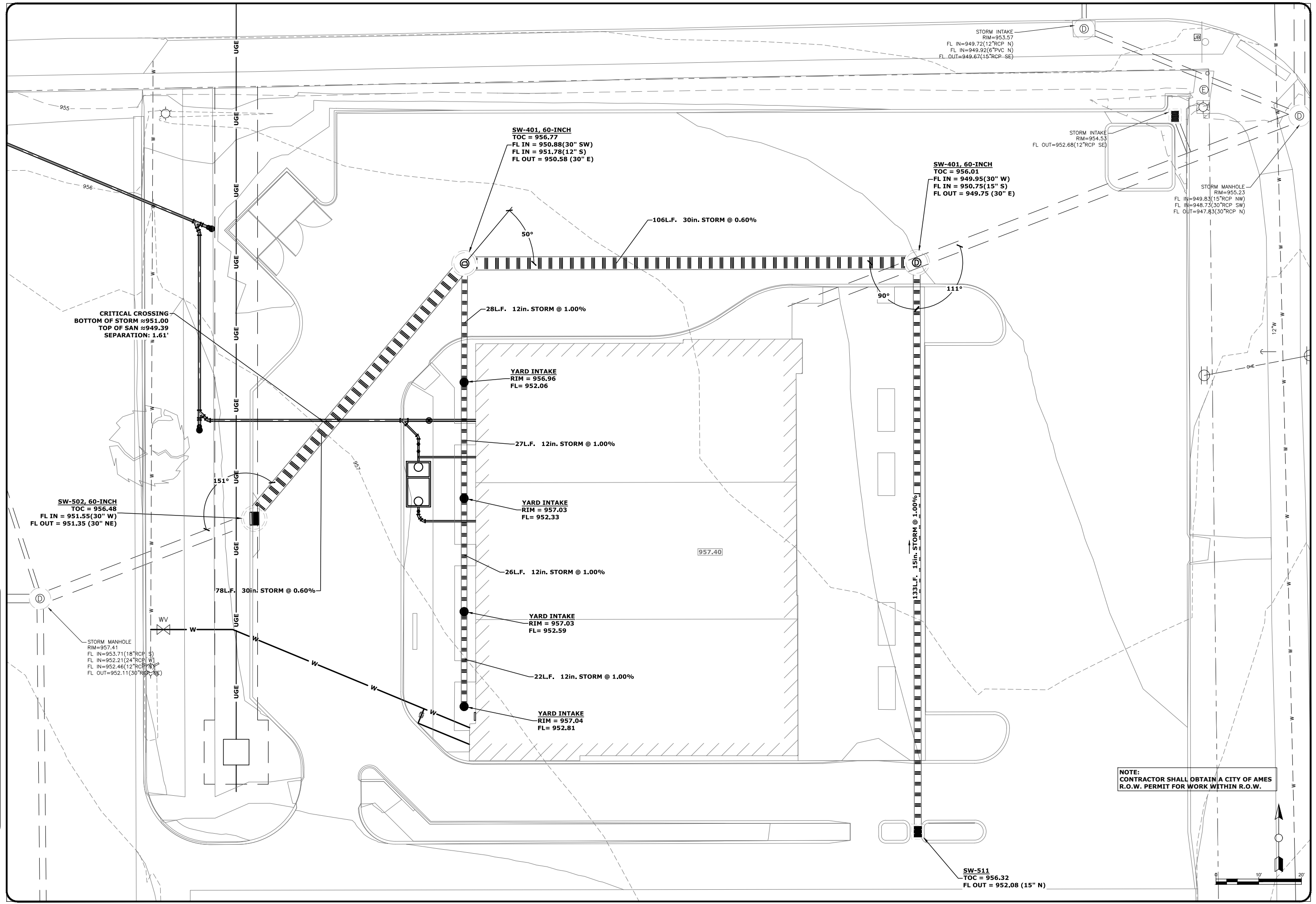

NOTE:
 CONTRACTOR SHALL OBTAIN A CITY OF AMES
 R.O.W. PERMIT FOR WORK WITHIN R.O.W.

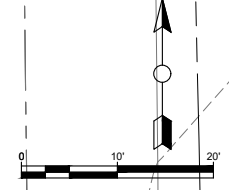

DATE	BY	REVISION
08/19/19	SAW	DESIGNED
08/19/19	SRS	DRAWN
08/21/19		CHECKED
		REVISED LAYOUT BASED ON P&Z COMMENTS
		LAST UPDATE:

FOX Engineering Associates, Inc.
 414 South 17th Street, Suite 107
 Ames, Iowa 50010
 Phone: (515) 233-0000
 FAX: (515) 233-0103

FOX Engineering

SITE UTILITY PLAN (STORM)
 NORTH GRAND MALL
 LOT F
 2801 GRAND AVENUE
 AMES, IA

PROJECT NO.
 5459-188

SHEET
C4.02

DRAWING FILENAME: K:\2010\5000\5459-188_North_Grand_Mall_Site_F\Drawings\Civil\5459-188_IMPROVEMENTS_PLAN.dwg
 PLOT STYLE TABLE: FoxGrayScale.ctb
 LAYER: MNGR_NAME
 LAYOUT NAME: C5.01

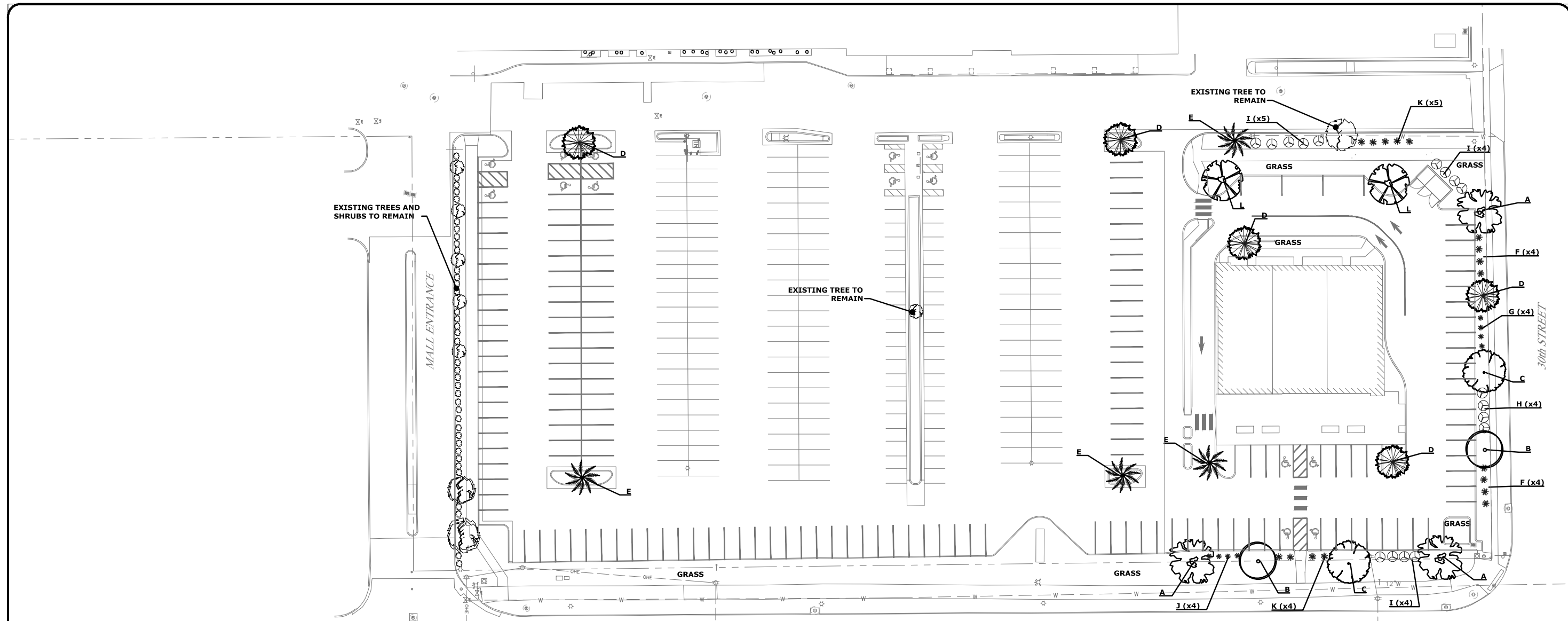

1 LANDSCAPING PLAN

GRAND AVENUE

LANDSCAPING NOTES

SOIL LOCATED IN REQUIRED PLANTING AREAS (YARD AREAS, BUFFER YARDS, OR PLANTERS) WILL BE ORIGINAL TOPSOIL FROM THE SITE.

CERTIFICATION OF THE SOIL CONDITION AND QUALITY (NO LESS THAN 5% ORGANIC) MUST BE PROVIDED BY A CONTRACTOR, LICENSED ENGINEER, OR LANDSCAPE SPECIALIST PRIOR TO APPROVAL OF THE FINAL OCCUPANCY CERTIFICATE FOR A BUILDING.

Plant Name	Quantity	Plant Size	Plant Spacing	Planting Date	Planting Location
A	4	12" W	12" W	08/19/19	30th Street
B	4	12" W	12" W	08/19/19	30th Street
C	4	12" W	12" W	08/19/19	30th Street
D	4	12" W	12" W	08/19/19	30th Street
E	4	12" W	12" W	08/19/19	30th Street
F	4	12" W	12" W	08/19/19	30th Street
G	4	12" W	12" W	08/19/19	30th Street
H	4	12" W	12" W	08/19/19	30th Street
I	4	12" W	12" W	08/19/19	30th Street
J	4	12" W	12" W	08/19/19	30th Street
K	4	12" W	12" W	08/19/19	30th Street
L	4	12" W	12" W	08/19/19	30th Street

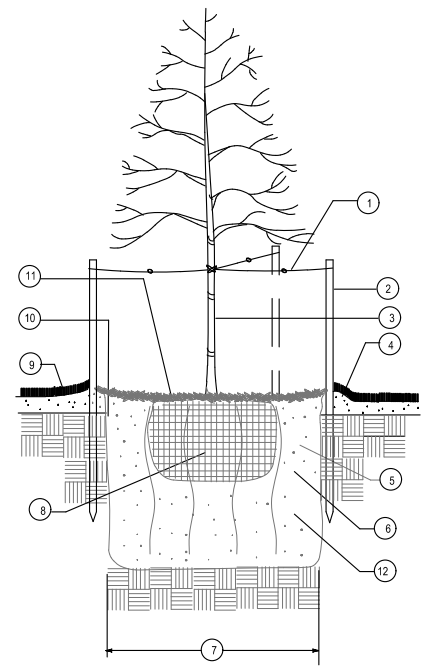

2 TREE PLANTING DETAIL
NOT TO SCALE

- 1 TREE TIE - FASTEN TO TREE TRUNK W/ RUBBER HOSE ABOUT SCAFFOLD BRANCHES
- 2 WOOD STAKE OR WOOD DEADMEN (8-10" EXPOSED) STAKE ON THREE SIDES SPACED 120 DEGREES APART
- 3 TREE TRUNK W/ WRAP
- 4 5" WATERING BASIN
- 5 FERTILIZER TABLETS (3" DEEP)
- 6 PLANTING BACKFILL
- 7 THREE TIMES ROOTBALL DIAMETER (MINIMUM)
- 8 ROOTBALL
- 9 FINISH GRADE
- 10 PLANT PIT W/ ROUGHENED SIDES
- 11 3-4" SHREDDED BARK/HARDWOOD MULCH
- 12 LOOSEN SOIL BY AUGER MIN. 2" BELOW ROOTBALL

NOTES:
 1. THE PLANTING HOLE SHOULD BE SHALLOW AND WIDE TO ALLOW FOR RAPID GROWTH AFTER PLANTING.
 2. DO NOT THIN CROWN. PRUNE DAMAGED OR BROKEN BRANCHES AS NEEDED.
 3. SET TREE 2-3 INCHES ABOVE FINISHED GRADE.
 4. APPLY WATER TO HOLE WHILE BACKFILLING TO ASSURE AIR POCKETS DO NOT FORM.

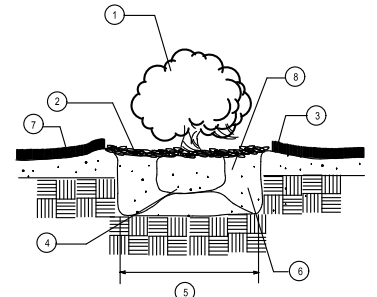

3 SHRUB PLANTING DETAIL
NOT TO SCALE

- 1 SHRUB
- 2 4" SHREDDED BARK MULCH
- 3 5" WATERING BASIN
- 4 ROOTBALL
- 5 TWICE ROOTBALL DIAMETER
- 6 FERTILIZER TABLET (1) - 3" DEEP
- 7 FINISH GRADE
- 8 PLANTING BACKFILL - SEE SPECIFICATION

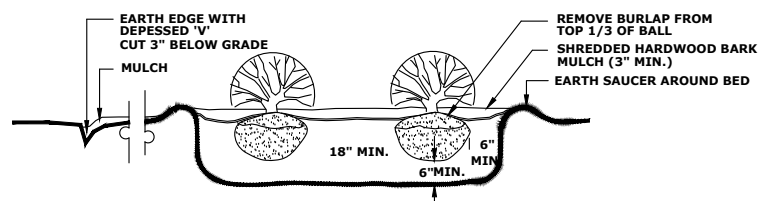

4 SHRUB PLANTING BED DETAIL
NOT TO SCALE

- 1 EARTH EDGE WITH DEEPSSED 'V' CUT 3" BELOW GRADE
- 2 MULCH
- 3 REMOVE BURLAP FROM TOP 1/3 OF BALL
- 4 SHREDDED HARDWOOD BARK MULCH (3" MIN.)
- 5 EARTH SAUCER AROUND BED

DATE	BY	REVISION
08/19/19	SAW	DESIGNED
08/19/19	SRS	DRAWN
08/21/19		CHECKED
08/21/19		LAST UPDATE

FOX Engineering Associates, Inc.
 414 South 17th Street, Suite 107
 Ames, Iowa 50010
 Phone: (515) 233-0000
 FAX: (515) 233-0103

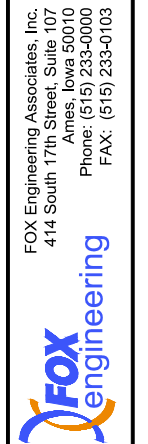

LANDSCAPING PLAN
 NORTH GRAND MALL
 LOT F
 2801 GRAND AVENUE
 AMES, IA

PROJECT NO.
5459-188

SHEET
C5.01

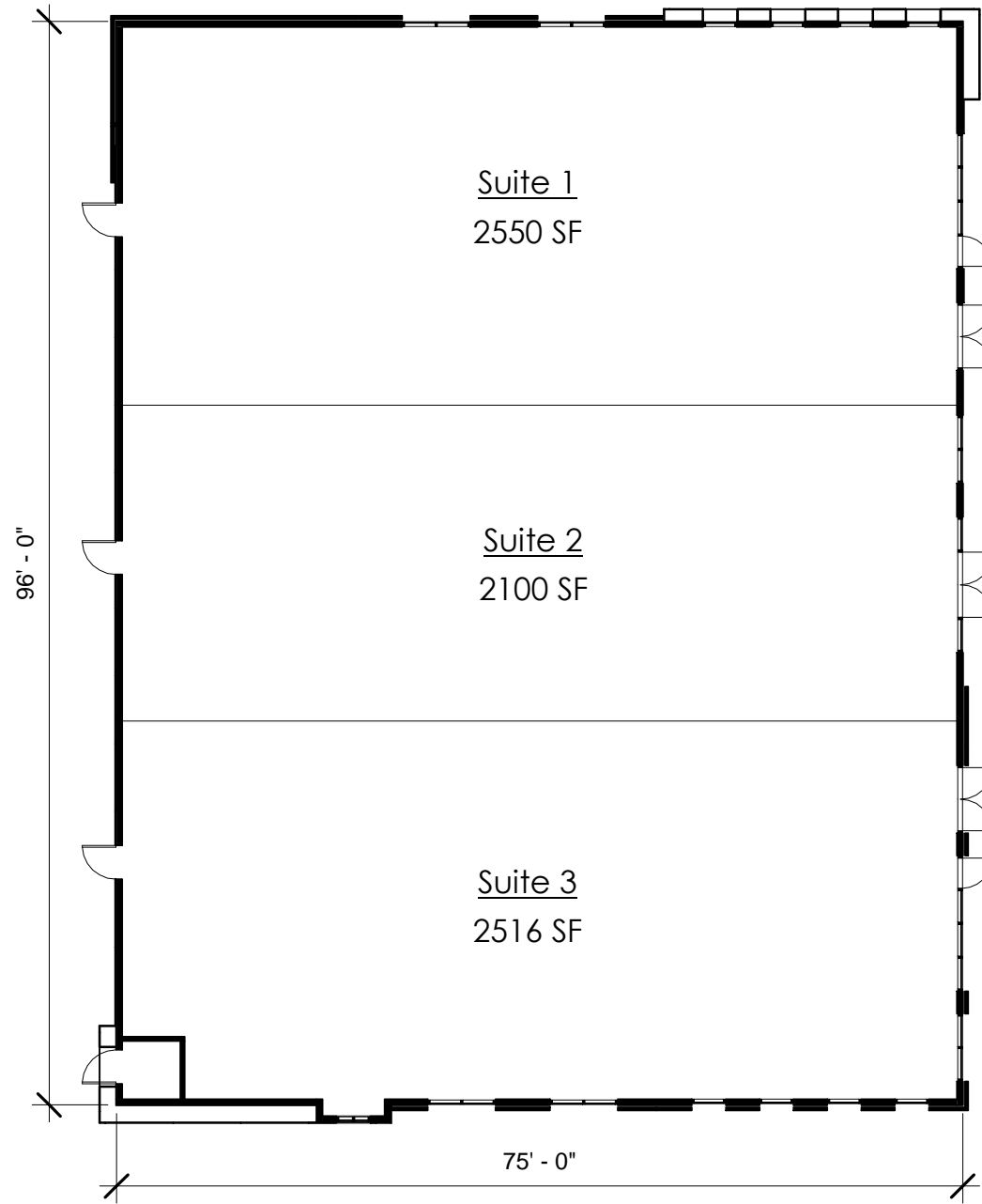

① First Floor
1/16" = 1'-0"

2801 Grand Ave. Retail

Concept Floor Plan

2019.07.31

19-002

PRACTIC
DESIGN



① NE 3D View



② SE 3D View

2801 Grand Ave. Retail

Concept 3D

2019.07.31

19-002

PRACTIC
DESIGN



① East Elevation
3/32" = 1'-0"

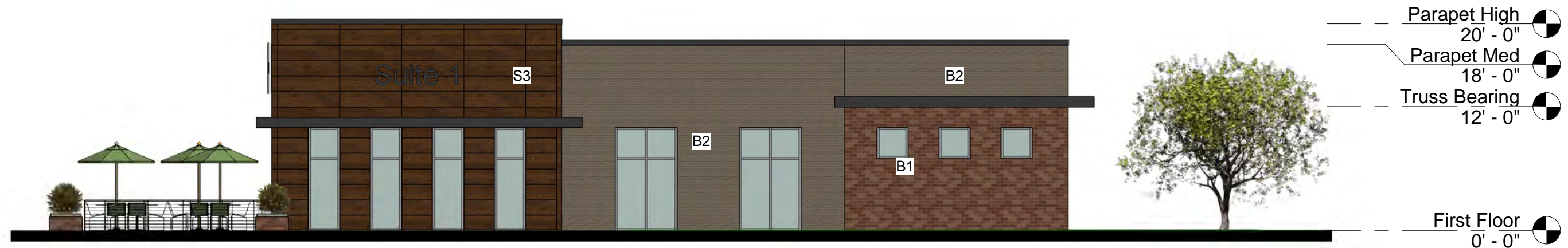

② North Elevation
3/32" = 1'-0"

Materials

- B1 Brown Brick
- B2 Tan Brick
- S1 Tan Fiber Cement Panel
- S2 Darker Fiber Cement Panel
- S3 Wood Fiber Cement Panel

2801 Grand Ave. Retail

Concept Elevations

2019.07.31
19-002

**PRACTIC
DESIGN**

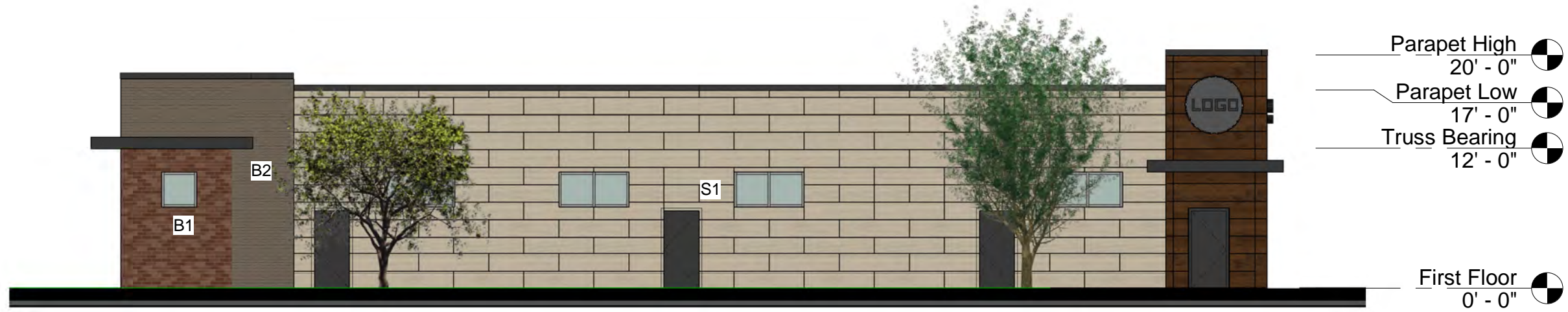

① West Elevation
3/32" = 1'-0"



② South Elevation
3/32" = 1'-0"

Materials

- B1 Brown Brick
- B2 Tan Brick
- S1 Tan Fiber Cement Panel
- S2 Darker Fiber Cement Panel
- S3 Wood Fiber Cement Panel

2801 Grand Ave. Retail

Concept Elevations

2019.07.31

19-002

PRACTIC
DESIGN

COUNCIL ACTION FORM

SUBJECT: CREATION OF A NEW CHAPTER OF THE AMES MUNICIPAL CODE, KNOWN AS CHAPTER 35, GUEST LODGING CODE- ESTABLISHING DEFINITIONS, ADMINISTRATION, STANDARDS, LICENSING, AND ENFORCEMENT FOR GUEST LODGING AND AMENDING THE TEXT OF THE ZONING ORDINANCE (CHAPTER 29) AND THE RENTAL HOUSING CODE (CHAPTER 13) TO ALLOW THEIR USE AND ESTABLISHING A FEE FOR LICENSURE.

BACKGROUND:

City Council provided direction on June 11, 2019 to remove the exemption from licensing for apartment tenants wishing to offer short-term rentals (**herein referred to as Guest Lodging**) from the proposed draft ordinances. Included in this revision, all offerings of Guest Lodging will be required to have a license. Additionally, as directed at the City Council meeting on April 23, 2019, Vacation Lodging has also been removed from the attached proposed ordinances. Vacation Lodging (formally referred to as a Vacation Rental) is the subject of a separate staff report.

Both Chapter 29 Zoning Ordinance and the new Chapter 35 Guest Lodging ordinance required modifications per City Council direction. Chapter 29 was modified to allow Guest Lodging as an Accessory Use for apartment buildings along with other minor administrative corrections. Chapter 35 was modified to add “Apartment Share” as a defined term along with other corresponding changes to the licensing and standards requirements. As result in the delay of proceeding with the ordinance, staff proposes to also delay implementation from September 1st to November 1st to allow for the same two months of implementation after adoption of the ordinances as was originally contemplated.

City Council had previously reviewed a draft of the proposed ordinances on February 26, 2019, and given direction to proceed with finalizing the text for the Guest Lodging Code and publishing notice for the text amendments to the Zoning Ordinance (Chapter 29). On November 13, 2018, the City Council had directed staff to proceed with drafting standards that would allow Guest Lodging within apartment dwellings and to proceed with described licensing system of one and two-family homes. City Council first reviewed a conceptual regulatory framework for on October 23rd regarding one and two-family homes.

Staff has worked with the City Attorney’s office to finalize the Guest Lodging Code and text amendments consistent with the Council’s direction. Guest Lodging is not a household living use, it is a lodging use that addresses how transient occupancy is allowed in conjunction with household living and the primary residents of a dwelling. Staff estimates that there are currently 50-60 properties that are advertised and that operate as a form of Guest Lodging.

Staff anticipates that the number would increase with legalization and awareness of the Guest Lodging options available.

The changes necessary to create a new use of Guest Lodging are extensive:

1. Create a new type of principal and accessory use within the Zoning Ordinance (Chapter 29),
2. Establish a new licensure chapter (Chapter 35) of the *Ames Municipal Code*, and
3. Modify the Rental Housing Code with clarifying text amendments.

A complete discussion of the proposed changes is included in the Addendum. The draft ordinances are included as Attachment 'A', and are summarized as follows:

- Duration of Stay. Guest Lodging is for a period of 31 consecutive days or less to the same person.
- Occupancy Limitations. Occupancy limitations vary by unit type and are generally based on the number of guest bedrooms with a maximum number of adults allowed.
- Approval. The intent is for an administrative review and approval for Hosted Home Shares and Home Shares as accessory uses. Amending the Bed & Breakfast special home occupation permit as an accessory use to become a Special Use Permit as a principal use.
- Annual licensing. An annual license is required. An annual licensing fee would be required in addition to any other city permits and fees.
- Parking. On-site parking subject to minimum parking requirements of Section 29.406.
- Fire Safety Requirements. Compliance with fire safety requirements of the Rental Housing Code (means of egress and fire protection systems) is required of all Guest Lodging units. A checklist will be made available and applicants will be required to indicate compliance.
- Inspections. All applications would be subject to verification and inspection for compliance. Subsequent inspections would be at the discretion of the Enforcement Officer.
- Renewal/Revocation Standards. The license to operate Guest Lodging may be revoked if it is determined that the Guest Lodging is operating inconsistent with the licensing standards or if there are verified complaints with notice of correction action regarding its operation. An appeal process to the Zoning Board of Adjustment is included.

The proposed regulations provide clear expectations with defined standards for the licensing and operating of Guest Lodging, and if needed, enforcement or license revocation. The goal is to minimize possible negative impacts to surrounding residential properties and neighborhoods from use of home for transient guest stays.

CODE COMPLIANCE & MONITORING:

The first step in achieving compliance with the adopted ordinances is public awareness of the new regulations. With City Council approval on first reading on July 23th and subsequent second and third readings in August, the new ordinances would be effective on or about September 1st. Staff proposes a delayed compliance period to allow time to receive and process applications, before enacting enforcement procedures, beginning on November 1st.

During the initial 60-day compliance period there would be no citations for operating an STR and if someone is in process of seeking a license they would not be subject to a citation during its review. Staff anticipates that review and approval of licensing applications can be incorporated into current inspection/planning duties.

Beyond providing public awareness, staff would have a limited ability to provide proactive compliance monitoring without address identification. The typical Airbnb listing data includes only a neighborhood map of listing, but does not where the unit is located with a property address.

Address information is not publically available without subscribing to a third party monitoring compliance software service. These types of vendors provide a proprietary evaluation of a listing to identify an address. An initial annual subscription with a monitoring compliance services for addresses and contact identification would help the City to proactively reach out to those who may be unaware of the new licensing requirements and would help to bring everyone into compliance. Staff's understanding of the pricing from one vendor indicates a price of \$1,500 based upon 50 listings in the City and a cost of \$30.00 per listing going forward.

However, Staff believes that that working through traditional methods would be effective in the initial stage of implementation due to the current estimated low number of listings. If staff is unsuccessful in efforts to obtain compliance from property owners, we can revisit the need for additional services.

LICENSING FEE:

A fee of \$50 would suffice in covering administration costs and would be in-line with the annual rental housing registration renewal fee for a single family home. In addition to the annual fee, an inspection fee would be charged with the initial application and may be charged for renewals if inspections are needed in the future. It is important to note that this license system is designed to be prospective about future use of the property, meaning a property owner is paying up front for the license, not paying for a prior year of licensure after the fact. Additionally, this license is to the property owner and a change in ownership will trigger a new license requirement and fee to issue a new one-year license. If City Council chooses to acquire a subscription to a monitoring service, reviewing license fees would be appropriate at that time.

ALTERNATIVES:

1a. The City Council can adopt on first reading by separate motion, each of the attached ordinances:

- i. Ordinance creating a new chapter of the *Ames Municipal Code* known as Chapter 35, Guest Lodging Code, establishing definitions, administration, standards, licensing, and enforcement for Guest Lodging, and
- ii. Ordinance amending the text of the Zoning Ordinance (Chapter 29), and
- iii. Ordinance amending text of the Rental Housing Code (Chapter 13) to allow the use of Guest Lodging, and

1b. The City Council can by resolution on third reading and passage of the ordinances described in Alternative #1a, establish a fee for Guest Lodging licensure for 2019-2020 at \$50.00.

2. City Council can continue the public hearing to a date certain and direct modifications to the draft ordinances prior to first reading. ***City Council would choose this Alternative if it directs a substantive change to the ordinances, such as including Vacation Lodging, formerly known as Vacation Rentals.***

3. The City Council can adopt on first reading, a modified version of any of the three attached ordinances and establish a fee for Guest Lodging licensure upon third reading of the ordinances.

MANAGER'S RECOMMENDED ACTION:

Staff has worked with the City Attorney's Office to finalize the Guest Lodging Code and text amendments consistent with the Council's direction. The changes necessary to address allowing Guest Lodging are extensive, as these would be a new type of principal and accessory use within the Zoning Ordinance (Chapter 29), and would establish a new category of licensure, incorporated into a new Chapter (Chapter 35) of the *Ames Municipal Code*. Clarifying text amendments are also needed within the Rental Housing Code.

With four types of proposed Guest Lodging (Apartment Share, Bed & Breakfast Establishment, Hosted Home Share, and Home Share), each has unique attributes related to occupancy, parking, and the approval process. However, objective criteria are included in the text to enable review for compliance and approval. Additional scrutiny through the Special Use Permit process for Bed & Breakfast Establishments will help to ensure neighborhood compatibility.

Upon adoption of new Guest Lodging standards, the goal would be to undergo a public education campaign to let people know of the new requirements. Staff believes allowing until November 1st to both receive initial applications would be appropriate, before enacting enforcement procedures.

Licensing allows for periodic contact with property owners and helps ensure continued compliance. An annual licensing fee similar in cost to a Single Family Rental Letter of Compliance Cost is planned for the proposed licensing process. A Council update on the status of Guest Lodging licensing and compliance 6-9 months after adoption, would shed

light on whether any adjustments to the initial fee (set with the adoption of the ordinances) would be warranted.

Therefore, it is the recommendation of the City Manager that the City Council adopt on first reading each of the attached ordinances as described in Alternative #1a and upon third reading and passage of the ordinances described in Alternative #1a, establish a fee for initial Guest Lodging licensure described in Alternative #1b.

However, in the event the City Council determines on July 23rd to reintroduce Vacation Lodging (formerly Vacation Rentals where the owner is not present), staff would recommend Alternative 2 to continue the public hearing to August 13th and bring back updated ordinances to the next meeting.

Addendum

The allowance of Guest Lodging as a transient occupancy use in residentially zoned areas has the potential to be incompatible with surrounding residential uses. Therefore, special regulation for short-term occupancy is necessary to ensure that Guest Lodging use will be compatible with surrounding residential uses and will not materially alter the character of neighborhoods in which they are located.

The Guest Lodging Code is proposed as a new chapter of the *Ames Municipal Code*. It establishes definitions, administration, standards, licensing, and enforcement for Guest Lodging. It provides reasonable and necessary regulations for the licensing and operation of Guest Lodging in order to:

- (1) Ensure the safety, welfare and convenience of renters, owners and neighboring property owners throughout Ames;
- (2) Help maintain the City's needed housing supply for household living; and
- (3) Protect the character of the City's neighborhoods by limiting the operations, number, and concentration of Guest Lodging in residential zones.

Objective standards are included to enable review for compliance and approval. The Guest Lodging period would be 31 consecutive days or less.

The Guest Lodging types include: apartment shares, hosted home shares; home shares; and bed & breakfast establishments. Additional scrutiny through the Special Use Permit process for Bed & Breakfast Establishments will help to ensure neighborhood compatibility.

Each of the proposed types of Guest Lodging has unique attributes related to occupancy, parking, and the approval process. In cases where the property owner is the primary resident, the Guest Lodging use may be considered as an accessory use to the use of a single-family dwelling as household living. A new definition for "primary residence" helps differentiate when Guest Lodging would be considered as an accessory or principal use.

The proposed text amendment to the Zoning Ordinance adds each of the Guest Lodging types to the list of permitted uses in Article 5. Uses would be included as either a new accessory use to Household Living or as a new principal use under Short-Term Lodging.

Apartment Shares

This new category of accessory use allows apartment tenants the ability to offer their dwelling unit for Guest Lodging with application by the property owner when the apartment is the primary residence of the tenant. Apartment shares are subject to the occupancy standards of Chapter 13. Each dwelling unit is licensed individually. A licensing application is required that would be administratively approved and required to be renewed annually.

Hosted Home Shares

As an incidental, accessory use, hosted home shares are the least impactful of the Guest Lodging types. Bedrooms that may be rented are limited to a maximum of two with no more than two adults as guests per dwelling unit. The dwelling is the primary residence of the property owner and the property owner is required to be on site and present during the rental period. This type of activity is viewed as an accessory use (subordinate and incidental to the residential use of the home). The impact of a hosted home share is not much greater than that of a private home with frequent houseguests. A licensing application is required that would be administratively approved and required to be renewed annually.

Home Shares

This option is somewhat unique in allowing for whole-house Guest Lodging facilities on limited basis without the primary resident present during the stay. The Guest Lodging code would allow a maximum of two adults per approved bedroom, not to exceed a total of five adults per dwelling unit. Approval would be by staff as an administrative process. Rental Housing Code registration is not required given the use of the home as a primary residence with a limited number of guest stay days in a year. The cumulative total of rental days allowed per annual renewal is 90 days. The proposed limitations are also meant to distinguish the Guest Lodging use from a use that should actually register as rental housing property subject to Chapter 13 requirements. In accordance with the Guest Lodging definition, the maximum stay for any guest is 31 consecutive days.

Bed & Breakfast Establishments (B&B's)

Bed & Breakfast Establishments are private homes or residences where the property owner resides, as their principal residence. Bed & Breakfast Establishments are permitted a maximum occupancy of two adults per approved bedroom for overnight Guest Lodging. The Zoning Board of Adjustment determines the number of bedrooms specific to the dwelling unit through the special use permitting process. No more than five bedrooms may be approved. B&B's are exempt from the City's Rental Housing Code; however, state licensing and inspection as a food establishment is required when there are more than four guest families accommodated. (Iowa Code, section 137F.1) The operating license would be required to be renewed annually.

PLANNING AND ZONING COMMISSION RECOMMENDATION:

The Planning & Zoning Commission reviewed the proposed ordinances for the use of single and two-family dwellings as Guest Lodging on September 19, 2018 and the use of apartments as Guest Lodging on January 16, 2019.

In each case, the P&Z made a unanimous recommendation of approval (5-0) with certain modifications or limitations as summarized below.

September 19, 2018 unanimous recommendation regarding single-family homes as Guest Lodging:

- Two-family dwellings be included, and

- That the City Council consider proactive compliance monitoring to ensure that all Guest Lodging properties are licensed.

January 16, 2019 unanimous recommendation regarding inclusion of apartments as Guest Lodging:

- Home Shares in rental apartments would be allowed as an accessory use in all zoning districts with no tenant or property owner license required; Oversight compliance would be the responsibility of the landlord.
- The Commission also recommended that if Vacation Rentals (Vacation Lodging) were an allowed use, that a maximum of 10% of apartment units could be used for such a use and that one and two-family dwellings be allowed subject to a special use permit approval as was originally described by staff. However, Vacation Rentals (Vacation Lodging) are not part of the draft ordinance.

The Planning & Zoning Commission's recommendations were incorporated into the updated draft ordinances and are part of the staff recommendation.

ORDINANCE NO.

AN ORDINANCE TO AMEND THE MUNICIPAL CODE OF THE CITY OF AMES, IOWA, BY ENACTING NEW SUBSECTIONS 29.201(14), 29.201(18.1), 29.201(19.1), AND 29.201(92.1) AND AMENDING CHAPTER 29 THEREOF, FOR THE PURPOSE OF HARMONIZING CHAPTER 29 WITH CHAPTER 35, GUEST LODGING CODE; REPEALING ANY AND ALL ORDINANCES OR PARTS OF ORDINANCES IN CONFLICT TO THE EXTENT OF SUCH CONFLICT; PROVIDING A PENALTY; AND ESTABLISHING AN EFFECTIVE DATE.

BE IT ENACTED, by the City Council for the City of Ames, Iowa, that:

Section One. The Municipal Code of the City of Ames, Iowa shall be and the same is hereby amended by enacting new subsections 29.201(14), 29.201(18.1), 29.201(19.1), and 29.201(92.1) and by amending Chapter 29 as follows:

“Sec. 29.201. DEFINITIONS.

Except as otherwise defined in this Ordinance or unless the context may otherwise require, the following words are defined for the purpose of this Ordinance as follows:

...

(14) **Apartment Dwelling** means a dwelling building containing three or more residential units. The term includes what is commonly known as an apartment building, but does not include community residential facilities or single-family attached dwellings. Apartment dwellings may be occupied by families only, or by a group of unrelated persons limited to five or less per residential unit.

~~*** Basement. See subsection 250.~~

...

(18.1) **Basement.** That floor level of a building between the upper surface of a floor and the ceiling or floor joists next above, which has at least 50% of the total area of its perimeter of foundational walls located below natural and finished grade.

...

(19.1) **Bed & Breakfast Establishment** means the Guest Lodging of a portion of a dwelling unit that is the primary residence of the property owner, where the property owner provides lodging and may provide breakfast for overnight guests. A Bed & Breakfast Establishment is a short-term lodging use and is a category of Guest Lodging licensed under Chapter 35.

...

(92.1) **Guest Lodging** means the advertising, offering, or otherwise availability of use of a dwelling unit for overnight lodging for a period of thirty-one (31) consecutive days or less in exchange for money, goods, labor or service. Guest Lodging types include Apartment Shares, Home Shares, Hosted Home Shares and Bed & Breakfast Establishments, as licensed under Chapter 35. Guest Lodging does not include any hotel or motel facility.

...

(250) ~~Basement. That floor level of a building between the upper surface of a floor and the ceiling or floor joists next above, which has at least 50% of the total area of its perimeter of foundational walls located below natural and finished grade.~~

...

Sec. 29.406. OFF-STREET PARKING.

...

**Table 29.406(2)
Minimum Off-Street Parking Requirements**

PRINCIPAL LAND USE	ALL ZONES EXCEPT DOWNTOWN AND CAMPUSTOWN SERVICE CENTER ZONES	DOWNTOWN AND CAMPUSTOWN SERVICE CENTER ZONES
RESIDENTIAL DWELLINGS		

<u>Group Living</u>		
Boarding houses, rooming houses, and lodging houses	1 space/bed	0.5 space/bed
College and University housing, fraternities and sororities	1 space/3 beds	NONE
Group Living Nursing and convalescent homes	1 space/5 beds, plus 1 space/2 staff members of the largest shift	NONE
<u>Short-Term Lodging</u>		
Bed & Breakfast Establishment	<u>1 space/guest bedroom, plus 1 space for the owner</u>	<u>N/A</u>
Short Term Lodging Hotel/Motel, including ancillary uses	1 space/guest room; plus 6 spaces/1,000 sf of ballroom, meeting, bar and restaurant areas; plus 1 space/2 employees of the largest shift	1 space/guest room; plus 6 spaces/1,000 sf of ballroom, meeting, bar and restaurant areas; plus 1 space/2 employees of the largest shift

...

Sec. 29.501. CLASSIFICATION OF USES.

...

(3) **Accessory Uses.** Unless otherwise stated in this Ordinance or otherwise indicated in the Use Tables for each zone:

...

(e) Accessory Uses: are incidental and customary to and commonly associated with the operation of the Principal Use;

i. ~~Are Is~~ clearly incidental and customary to and commonly associated with the operation of the Principal Use;

ii. ~~Are Is~~ operated and maintained under the same ownership or by lessees or concessionaires of the owner, and on the same zone lot as the Principal Use;

iii. ~~Do Does~~ not include structures or structural features inconsistent with the Principal Use;

iv. May include the Guest Lodging of all or a portion of a household living dwelling unit that is the primary residence of the property owner. May also include the use of apartment dwelling units for Guest Lodging, consistent with the licensing requirements of Chapter 35, when apartment dwellings are permitted in the base zone.;

v. ~~iv. Does~~ Do not include residential occupancy in conjunction with uses other than other than hotels, motels, tourist homes and similar uses offering transient housing accommodations, which is also not permitted except by owners and employees employed on the premises and of the immediate families of such owners and employees; and

~~vi. v. Has~~ Have a gross floor area that, in combination with all other uses accessory to Principal Uses located in the same structure or on the same lot, does not exceed 25% of the gross floor area utilized by all Principal Uses. ~~This~~ The 25% floor area limitation, ~~however, shall~~ does not apply to off-street parking. Guest Lodging is exempt from the 25% floor area limitation.

...

**Table 29.501(4)-1
RESIDENTIAL USE CATEGORIES**

Household Living

Accessory Uses

Home Share

Hosted Home Share

Short-Term Lodging

Definition. Facilities offering ~~transient~~ lodging accommodations to the general public, where the average length of stay is ~~less than 60~~ 31 days or less. Short-term lodging is subject to State of Iowa definitions, permits, and rules, including remittance of hotel and motel tax.

Uses Included

~~Boarding, rooming or lodging houses and single room occupancy (SRO) hotels, where the average length of stay is less than 60 days.~~

~~Bed and breakfasts~~ Bed & Breakfast Establishment

~~Hotels~~ Hotel

~~Motels~~ Motel

~~Recreational Vehicle Parks~~ Recreational Vehicle Park

Accessory Uses

Coffee shops and dining areas primarily for use by guests or residents of the facility.

...

Sec. 29.600. "A" AGRICULTURAL.

...

Table 29.600(2)
Agricultural (A) Zone Uses

USE CATEGORIES	STATUS	APPROVAL REQUIRED	APPROVAL AUTHORITY
RESIDENTIAL USES			
Group Living	N		
<u>Household Living</u>			

Household Living Accessory Uses			
Accessory Apartment	N		
Home Office	Y	HO	ZBA/Staff
Home Occupation <u>Home Business</u>	Y	HO	ZBA/Staff
<u>Home Share</u>	<u>Y</u>	<u>ZP</u>	<u>ZEO</u>
<u>Hosted Home Share</u>	<u>Y</u>	<u>ZP</u>	<u>ZEO</u>
Short-term Lodgings <u>Short-Term Lodging</u>	N		
<u>Bed & Breakfast Establishment</u>	<u>Y</u>	<u>SP</u>	<u>ZBA</u>

...

Sec. 29.701. "RL" RESIDENTIAL LOW DENSITY.

...

Table 29.701(2)
Residential Low Density (RL) Zone Uses

USE CATEGORIES	STATUS	APPROVAL REQUIRED	APPROVAL AUTHORITY
RESIDENTIAL USES			

Household Living Accessory Uses			
Clubhouse	N		
Home Office	Y	HO	ZBA/Staff
Home Occupation <u>Home Business</u>	Y	HO	ZBA/Staff
<u>Home Share</u>	<u>Y</u>	<u>ZP</u>	<u>ZEO</u>
<u>Hosted Home Share</u>	<u>Y</u>	<u>ZP</u>	<u>ZEO</u>
Short-term Lodgings <u>Short-Term Lodging</u>	N, except Bed and Breakfast permitted as a Home Occupation.	HO	ZBA/Staff
<u>Bed & Breakfast Establishment</u>	<u>Y</u>	<u>SP</u>	<u>ZBA</u>

...

Sec. 29.702. "RM" RESIDENTIAL MEDIUM DENSITY.

...

Table 29.702(2)
Residential Medium Density (RM) Zone Uses

USE CATEGORIES	STATUS	APPROVAL REQUIRED	APPROVAL AUTHORITY
RESIDENTIAL USES			

Household Living Accessory Uses			
Clubhouse	N		
Home Office	Y	HO	ZBA/Staff
Home Occupation-Home Business	Y	HO	ZBA/Staff
<u>Home Share</u>	<u>Y</u>	<u>ZP</u>	<u>ZEO</u>
<u>Hosted Home Share</u>	<u>Y</u>	<u>ZP</u>	<u>ZEO</u>
Short-term Lodgings Short-Term Lodging	N, except Bed and Breakfast permitted as a Home Occupation.	HO	ZBA/Staff
<u>Bed & Breakfast Establishment</u>	<u>Y</u>	<u>SP</u>	<u>ZBA</u>

...

Sec. 29.703. "UCRM" URBAN CORE RESIDENTIAL MEDIUM DENSITY ZONE.

...

Table 29.703(2)
Urban Core Residential Medium Density (UCRM) Zone Uses

USE CATEGORIES	STATUS	APPROVAL REQUIRED	APPROVAL AUTHORITY
RESIDENTIAL USES			

Household Living Accessory Uses			
Clubhouse	N		
Home Office	Y	HO	ZBA/Staff
Home Occupation-Home Business	Y	HO	ZBA/Staff
<u>Home Share</u>	<u>Y</u>	<u>ZP</u>	<u>ZEO</u>
<u>Hosted Home Share</u>	<u>Y</u>	<u>ZP</u>	<u>ZEO</u>
Short-term Lodgings Short-Term Lodging	N, except Bed and Breakfast permitted as a Home Occupation	HO	ZBA/Staff
<u>Bed & Breakfast Establishment</u>	<u>Y</u>	<u>SP</u>	<u>ZBA</u>

...

Sec. 29.704. "RH" RESIDENTIAL HIGH DENSITY.

...

Table 29.704(2)
Residential High Density (RH) Zone Uses

USE CATEGORIES	STATUS	APPROVAL REQUIRED	APPROVAL AUTHORITY
RESIDENTIAL USES			

Household Living Accessory Uses			
Clubhouse	Y	SDP Minor	Staff
Home Office	Y	HO	ZBA/Staff
Home Occupation-Home Business	Y	HO	ZBA/Staff
<u>Home Share</u>	<u>Y</u>	<u>ZP</u>	<u>ZEO</u>
<u>Hosted Home Share</u>	<u>Y</u>	<u>ZP</u>	<u>ZEO</u>
Short-term Lodgings Short-Term Lodging	N, except Bed and Breakfast permitted as a Home Occupation	HO	ZBA/Staff
<u>Bed & Breakfast Establishment</u>	<u>Y</u>	<u>SP</u>	<u>ZBA</u>

...

Sec. 29.705. "RLP" RESIDENTIAL LOW DENSITY PARK ZONE.

Table 29.705(4)
Residential Low Density Park (RLP) Zone Uses

USE CATEGORY	STATUS	APPROVAL REQUIRE D	APPROVAL AUTHORITY
RESIDENTIAL USES			

Household Living	Y	SDP Major	City Council. Single-Family Manufactured Home and accessory uses listed in Table 29.500 only. Home Office and Home Business allowed as necessary uses.
<u>Manufactured Housing</u>	<u>Y</u>	<u>SDP Major</u>	<u>City Council</u>
<u>Household Living Accessory Uses</u>	-	-	-
<u>Accessory Uses Specific to Manufactured Housing</u>	<u>Y</u> , see Table 29.501(4)- <u>1</u>	<u>SDP Major/ZP</u>	<u>City Council/Staff</u>
<u>Home Occupation</u>	<u>Y</u>	<u>SP</u>	<u>ZBA</u>
<u>Home Share</u>	<u>Y</u>	<u>ZP</u>	<u>ZEO</u>
<u>Hosted Home Share</u>	<u>Y</u>	<u>ZP</u>	<u>ZEO</u>
<u>Short-term Lodgings Short-Term Lodging</u>	N	-	

- Y = Yes; permitted as indicated by required approval
 N = No; prohibited
 SP = Special Use Permit required; See Section 29.1503
 ZP = Building/Zoning Permit required; See Section 29.1501
 SDP Minor = Site Development Plan Minor; See Section 19.1502(3)
 SDP Major = Site Development Plan Major; See Section 19.1502(4)
 ZBA = Zoning Board of Adjustment
 ZEO = Zoning Enforcement Officer

...

Sec. 29.801. “NC” NEIGHBORHOOD COMMERCIAL ZONING STANDARDS.

...

**Table 29.801(2)
Neighborhood Commercial (NC) Zone Uses**

USE CATEGORY	STATUS	APPROVAL REQUIRED	APPROVAL AUTHORITY
RESIDENTIAL USES			

Household Living Accessory Uses	-	-	-
<u>Home Share</u>	<u>Y</u>	<u>ZP</u>	<u>ZEO</u>
<u>Hosted Home Share</u>	<u>Y</u>	<u>ZP</u>	<u>ZEO</u>
Short-term Lodgings <u>Short-Term Lodging</u>	<u>N</u>	-	
<u>Bed & Breakfast Establishment</u>	<u>Y</u>	<u>SP</u>	<u>ZBA</u>

- Y = Yes; permitted as indicated by required approval
- N = No; prohibited
- SP = Special Use Permit required; See Section 29.1503
- ZP = Building/Zoning Permit required; See Section 29.1501
- SDP Minor = Site Development Plan Minor; See Section 19.1502(3)
- SDP Major = Site Development Plan Major; See Section 19.1502(4)
- ZBA = Zoning Board of Adjustment
- ZEO = Zoning Enforcement Officer

...

Sec. 29.802. “CCN” COMMUNITY COMMERCIAL NODE.

...

**Table 29.802(2)
Community Commercial Node (CCN) Zone Uses**

USE CATEGORY	STATUS	APPROVAL REQUIRED	APPROVAL AUTHORITY
RESIDENTIAL USES			

Household Living	N		
Short-term Lodgings <u>Short-Term Lodging</u>	<u>Y, except Bed & Breakfast Establishment</u>	SDP Minor	Staff

...

Sec. 29.804. "HOC" HIGHWAY-ORIENTED COMMERCIAL.

...

Table 29.804(2)
Highway-Oriented Commercial (HOC) Zone Uses

USE CATEGORY	STATUS	APPROVAL REQUIRED	APPROVAL AUTHORITY
RESIDENTIAL USES			

<u>Short-term Lodgings</u> <u>Short-Term Lodging</u>	Y, except <u>Bed & Breakfast Establishment</u>	SDP Minor	Staff

...

29.805. "PRC" PLANNED REGIONAL COMMERCIAL.

...

Table 29.805(2)
Planned Regional Commercial (PRC) Zone Uses

USE CATEGORY	STATUS	APPROVAL REQUIRED	APPROVAL AUTHORITY
RESIDENTIAL USES			

<u>Short-term Lodgings</u> <u>Short-Term Lodging</u>	Y, except <u>Bed & Breakfast Establishment</u>	SDP Minor	Staff
***			-

...

Sec. 29.806. "CCR" COMMUNITY COMMERCIAL/RESIDENTIAL NODE.

...

Table 29.806(2)
Community Commercial/Residential Node (CCR) Zone Uses

USE CATEGORY	STATUS	APPROVAL REQUIRED	APPROVAL AUTHORITY
RESIDENTIAL USES			

<u>Short-term Lodgings</u> <u>Short-Term Lodging</u>	Y, except <u>Bed & Breakfast Establishment</u>	SDP Minor	Staff

...

Sec. 29.808. "DSC" DOWNTOWN SERVICE CENTER.

...

**Table 29.808(2)
Downtown Service Center (DSC) Zone Uses**

USE CATEGORY	STATUS	APPROVAL REQUIRED	APPROVAL AUTHORITY
RESIDENTIAL USES			

<u>Short term Lodgings</u> <u>Short-Term Lodging</u>	<u>Y, except Bed & Breakfast Establishment</u>	SDP Minor	Staff

...

Sec. 29.809. "CSC" CAMPUSTOWN SERVICE CENTER.

...

**Table 29.809(2)
Campustown Service Center (CSC) Zone Uses**

USE CATEGORY	STATUS	APPROVAL REQUIRED	APPROVAL AUTHORITY
RESIDENTIAL USES			

<u>Short term Lodgings</u> <u>Short-Term Lodging</u>	<u>Y, except Bed & Breakfast Establishment</u>	SDP Minor	Staff

...

Sec. 29.903. ~~Research Park Innovation District (RI)~~ "RI" RESEARCH PARK INNOVATION DISTRICT.

...

**Table 29.903(2)
RI Zone Uses**

USE CATEGORIES	STATUS	APPROVAL REQUIRED	APPROVAL AUTHORITY
RESIDENTIAL USES			

<u>Short term Lodgings</u> <u>Short-Term Lodging</u>	<u>Y, except Bed & Breakfast Establishment</u>	SDP Minor	Staff

...

Sec. 29.1003. “S-SMD” SOUTH LINCOLN SUB AREA MIXED-USE DISTRICT.

...

Table 29.1003(2)
South Lincoln Sub Area (S-SMD) Mixed-Use District

USE CATEGORY	STATUS	APPROVAL REQUIRED	APPROVAL AUTHORITY
RESIDENTIAL USES			

Household Living Accessory Uses			
Home Office	Y	HO	ZBA/Staff
Home Occupation Home Business	Y	HO	ZBA/Staff
Home Share	Y	ZP	ZEO
Hosted Home Share	Y	ZP	ZEO
Short-term Lodgings Short-Term Lodging	N, except Bed and Breakfast permitted as a Home Occupation	HO	ZBA/Staff
Bed & Breakfast Establishment	Y	SP	ZBA

...

Sec. 29.1004. "DGC" DOWNTOWN GATEWAY COMMERCIAL.

...

Table 29.1004(2)
Downtown Gateway Commercial Uses

USE CATEGORY	STATUS	APPROVAL REQUIRED	APPROVAL AUTHORITY
RESIDENTIAL USES			

Short-term Lodging Short-Term Lodging (stand alone or mixed use)	Y, except Bed & Breakfast Establishment	SDP Major	Staff

...

Sec. 29.1101. “O-SFC” SINGLE FAMILY CONSERVATION OVERLAY.

(4) Permitted Uses.

(a) Subject to the Building/Zoning Permit requirements of Section 29.1501, land, buildings and structures may be used for the following purposes in an O-SFC Zone without City Council approval, in accordance with standards and regulations of the Base Zone:

(i) Dwelling - Single-Family

(ii) Dwelling – Two Family

(iii) Bed & Breakfast Establishment (Special Use Permit required: See Section 29.1503)

(b) All uses and structures conforming to the Base Regulations and all lawfully vested nonconforming uses and structures that exist in the O-SFC on the effective date of the amendment of the official zoning map to show the O-SFC are hereby deemed to be conforming with the terms of this Section. The O-SFC shall not be deemed to create a nonconforming use or structure within the scope of Section 29.307.

...

Sec. 29.1201. “F-VR” VILLAGE RESIDENTIAL DISTRICT.

...

**Table 29.1201(5)
Village Residential (F-VR) Floating Zone Uses**

USE CATEGORY	NEIGHBORHOOD CENTER	NEIGHBORHOOD GENERAL	NEIGHBORHOOD EDGE

OTHER USES			

Essential Public Services	Y	Y	Y
<u>Household Accessory Uses*</u>	<u>Y</u>	<u>Y</u>	<u>Y</u>

*Guest Lodging is subject to the requirements of Chapter 35; Home Occupations are subject to Section 29.1304.

...

Sec. 29.1202. "F-S" SUBURBAN RESIDENTIAL ZONE.

...

Table 29.1202(4)-1
Suburban Residential Floating Zoning
Residential Low Density (FS-RL) Uses

USE CATEGORIES	STATUS	APPROVAL REQUIRED	APPROVAL AUTHORITY
RESIDENTIAL USES			

Household Living Accessory Uses			
Clubhouse	N		
Home Office	Y	HO	ZBA/Staff
Home Occupation-Home Business	Y	HO	ZBA/Staff
<u>Home Share</u>	<u>Y</u>	<u>ZP</u>	<u>ZEO</u>
<u>Hosted Home Share</u>	<u>Y</u>	<u>ZP</u>	<u>ZEO</u>
Short-term Lodgings Short-Term Lodging	N, except Bed and Breakfast permitted as a Home Occupation	HO	ZBA/Staff
<u>Bed & Breakfast Establishment</u>	<u>Y</u>	<u>SP</u>	<u>ZBA</u>

...

Table 29.1202(4)-2
Suburban Residential Floating Zoning
Residential Medium Density (FS-RM) Uses

USE CATEGORIES	STATUS	APPROVAL REQUIRED	APPROVAL AUTHORITY
RESIDENTIAL USES			

Household Living Accessory Uses			
Clubhouse	Y	SDP Major	City Council
Home Office	Y	HO	ZBA/Staff
Home Occupation-Home Business	Y	HO	ZBA/Staff
<u>Home Share</u>	<u>Y</u>	<u>ZP</u>	<u>ZEO</u>
<u>Hosted Home Share</u>	<u>Y</u>	<u>ZP</u>	<u>ZEO</u>
Short-term Lodgings Short-Term Lodging	N, except Bed and Breakfast permitted as a Home Occupation	HO	ZBA/Staff
<u>Bed & Breakfast Establishment</u>	<u>Y</u>	<u>SP</u>	<u>ZBA</u>

...

Sec. 29.1203. "F-PRD" PLANNED RESIDENCE DISTRICT.

...

**Table 29.1203(4)
Planned Residence District (F-PRD) Floating Zone Uses**

Permitted Principle Uses	Permitted Accessory Uses
***	Accessory uses of the Household Living category provided for in <u>Table 29.501(4)-1 Section 29.500</u> of this ordinance. Garages Open space uses Home occupations subject to standards of Section 29.1304 of this ordinance Home Day Care subject to the standards of Section 29.1304 Office and Trade use where the property owner can demonstrate through a written Market Study that the Office and Trade use can be supported by the residents of the Planned Residence District Project Rental services offices not to exceed 5,000 square feet Assisted Living, for the residents of the PRD

...

Sec. 29.1302. GUEST LODGING REQUIREMENTS, BED & BREAKFAST ESTABLISHMENTS.

- (1) **Special Use Permit.** Bed & Breakfast Establishments must obtain a Special Use Permit from the Zoning Board of Adjustment prior to receiving a Guest Lodging license. The Special Use Permit is not transferable to a subsequent owner or to another property.
- (2) **Guest Rooms.** Bed & Breakfast Establishments may have no more than five approved guest bedrooms. The Zoning Board of Adjustment will determine the number of bedrooms specific to the dwelling unit.
- (3) **Off-Street Parking Requirements.** Bed & Breakfast Establishments must have one reserved space per guest room, plus one space for the owner. The parking spaces shall meet standards established by Section 29.406 of this ordinance.
- (4) **Local and State Regulations.** The Guest Lodging establishment must comply with local and state regulations regarding all applicable permits and licenses including, but not limited to fire, health, food service, hotel, liquor, revenue, building/zoning permits and licenses.

To obtain a Special Use Permit for a Bed & Breakfast Establishment, all criteria in "Home Occupations," set forth in Section 29.1304, must be met, in addition to the following:

- (1) ~~Guest Rooms.~~ A maximum of 5 per structure in the RM and RH Zones and a maximum of 2 per structure in the RL Zone. The Zoning Board of Adjustment may restrict the number of guest rooms to a lesser number.
- (2) ~~Breakfast shall be the only meal served.~~ This service must occur before 11:00 a.m. Only guests residing in the structure or persons living in the premises may be served. The structure shall not be remodeled into a commercial kitchen unless required by Environmental Health rules and regulations established pursuant to Municipal Code Chapter 11.
- (3) ~~Off-Street Parking Requirements.~~ One space per guest room, plus one space for the owner. The parking spaces shall meet standards established by Section 29.406 of this ordinance.
- (4) ~~Guests shall register~~ upon arrival, stating their names, current residence address and the license plate number of the vehicle that is being used by the guest. The registration form shall be kept by the owner for a period of 3 years and shall be made available for examination by a representative of the City upon one day's notice.
- (5) ~~Guest stays shall be limited to 2 weeks.~~
- (6) ~~The Special Use Permit is not transferable to a subsequent owner or to another property.~~

~~(7) The establishment must comply with local and state regulations regarding all applicable permits and licenses including, but not limited to fire, health, food service, hotel, liquor, revenue, building/zoning permits and licenses.~~

...

Sec. 29.1304. HOME OCCUPATIONS.

...

(1) Permitted, Special and Prohibited Home Occupations.

...

~~(viii) Bed and breakfast operations;~~

....”

Section Two. Violation of the provisions of this ordinance shall constitute a municipal infraction punishable as set out in Ames Municipal Code Chapter 29.

Section Three. All ordinances, or parts of ordinances, in conflict herewith are hereby repealed to the extent of such conflict, if any.

Section Four. This ordinance shall be in full force and effect from and after its passage and publication as required by law. Enforcement of this ordinance shall begin on January 1, 2019.

Passed this _____ day of _____, _____.

Diane R. Voss, City Clerk

John A. Haila, Mayor

ORDINANCE NO.

AN ORDINANCE TO AMEND THE MUNICIPAL CODE OF THE CITY OF AMES, IOWA, BY ENACTING A NEW SECTION 13.100(5)(b) THEREOF, FOR THE PURPOSE OF HARMONIZING CHAPTER 13 WITH CHAPTER 35, GUEST LODGING CODE; REPEALING ANY AND ALL ORDINANCES OR PARTS OF ORDINANCES IN CONFLICT TO THE EXTENT OF SUCH CONFLICT; PROVIDING A PENALTY; AND ESTABLISHING AN EFFECTIVE DATE.

BE IT ENACTED, by the City Council for the City of Ames, Iowa, that:

Section One. The Municipal Code of the City of Ames, Iowa shall be and the same is hereby amended by enacting a new Section 13.100(5)(b) as follows:

“Sec. 13.100 GENERAL

...

(5) Exceptions.

The following residential structures are exempt from these rules:

...

(b) the use of a dwelling unit, wholly or partially, as a Bed & Breakfast Establishment, Home Share, or Hosted Home Share licensed under Chapter 35.

...”

Section Two. Violation of the provisions of this ordinance shall constitute a municipal infraction punishable as set out in Ames Municipal Code Chapter 13.

Section Three. All ordinances, or parts of ordinances, in conflict herewith are hereby repealed to the extent of such conflict, if any.

Section Four. This ordinance shall be in full force and effect from and after its passage and publication as required by law. Enforcement of this ordinance shall begin on January 1, 2019.

Passed this _____ day of _____, _____.

Diane R. Voss, City Clerk

John A. Haila, Mayor

ORDINANCE NO.

AN ORDINANCE TO AMEND THE MUNICIPAL CODE OF THE CITY OF AMES, IOWA, BY ENACTING A NEW CHAPTER 35, GUEST LODGING CODE THEREOF FOR THE PURPOSE OF REGULATING GUEST LODGING IN THE CITY OF AMES, IOWA; PROVIDING A PENALTY; AND ESTABLISHING AN EFFECTIVE DATE.

BE IT ENACTED, by the City Council for the City of Ames, Iowa, that:

Section One. The Municipal Code of the City of Ames, Iowa shall be and the same is hereby amended by enacting a new Chapter as follows:

“[NEW] Chapter 35 GUEST LODGING CODE

Sec. 35.100. TITLE, PURPOSE AND SCOPE.

These regulations shall be known as the Guest Lodging Code of the City of Ames, hereinafter referred to as “this code.”

In the adoption of this code, the City finds that the Guest Lodging of dwelling units has the potential to be incompatible with surrounding residential uses. Therefore, special regulation for short-term occupancy is necessary to ensure that these uses will be compatible with surrounding residential uses and will not materially alter the character of neighborhoods in which they are located. This code provides reasonable and necessary regulations for the licensing and operation of Guest Lodging in order to:

- (1) Ensure the safety, welfare and convenience of guests, owners and neighboring property owners throughout Ames;
- (2) Help maintain the City’s needed housing supply for household living; and
- (3) Protect the character of the City’s neighborhoods by limiting the operations, number, and concentration of Guest Lodging in residential zones.

Sec. 35.200. DEFINITIONS.

For the purposes of this code, the following words, terms and phrases have the meanings set forth herein. Where terms are not defined herein but are defined elsewhere, such as in *Ames Municipal Code Chapter 13, Rental Housing Code or Chapter 29, Zoning Ordinance*, such terms have the meanings ascribed therein.

Apartment Share means the Guest Lodging of a portion or the entire dwelling unit within an apartment building that is the primary residence of the tenant.

Applicant means a property owner or agent of a property owner who has filed an application for a Guest Lodging license.

Bed & Breakfast Establishment means the Guest Lodging of a portion of a dwelling unit that is the primary residence of the property owner, where the property owner is present and provides lodging, and may provide breakfast for overnight guests.

Bedroom, Approved Bedroom means any room or space used or intended to be used for sleeping purposes that is found to be in compliance with the standards of Chapter 13.

Enforcement Officer means that person or persons designated by the City Manager who is responsible for the administration and enforcement of this code.

Dwelling Unit means a single unit providing complete, independent living facilities for one or more persons, including permanent provisions for living, sleeping, eating, cooking and sanitation.

Guest Contract means one or more persons who act as a single group and as a single reservation and payment for a Guest Lodging.

Guest Lodging means the advertising, offering, or otherwise availability of use of a dwelling unit for overnight lodging for a period of thirty-one (31) consecutive days or less in exchange for money, goods, labor or service. Guest Lodging does not include any hotel or motel facility.

Guest Lodging License means the regulatory license required by this code.

Home Share means the limited Guest Lodging of the entire dwelling unit that is the primary residence of the property owner, while the property owner is not present.

Hosted Home Share means the limited Guest Lodging of a portion of a dwelling unit that is the primary residence of the property owner, while the property owner is present. For the purposes of this definition, “present” means the property owner is staying in the dwelling overnight during the Guest Lodging.

Letter of Compliance means a document issued by the Inspection Division, stating the premises have been inspected and found to be in compliance with *Ames Municipal Code Chapter 13, Rental Housing Code*, on the date of inspection.

Owner means any person, agent, operator, firm or corporation having a legal or equitable interest in the property; or recorded in the official records of the state, county or municipality as holding title to the property; or otherwise having control of the property, including the guardian of the estate of any such person, and the executor or administrator of the estate of such person if ordered to take possession of real property by a court.

Primary Residence means a dwelling unit that is the only place where a person has a true, fixed, and permanent home, and to where, whenever the person is briefly and temporarily absent, the person intends to return. A person may have only one primary residence.

Sec. 35.300. GUEST LODGING LICENSING

- (1) **License Required.** No person or entity may advertise, offer, let, operate, or otherwise make available Guest Lodging without a current Guest Lodging license issued by the City of Ames in accordance with the provisions of this code.

35.400 GUEST LODGING STANDARDS

- (1) **Application.** Any property owner or entity intending to allow or carry on the business of offering Guest Lodging on their property must submit a written application with the Enforcement Officer demonstrating that the proposed Guest Lodging meets the required standards of this code. To receive approval, an applicant must demonstrate that all applicable standards listed below have been met:
 - (a) **Applicant is the Property Owner.** A license must be obtained and renewed annually by the property owner and will be issued in the property owner’s name. Each dwelling unit is licensed individually.
 - (i) **Primary Residence.** The dwelling unit is the primary residence of the property owner for a Home Share, Hosted Home Share, and Bed & Breakfast Establishment and the primary residence of the tenant for an Apartment Share.
 - (b) **Zoning.** The dwelling unit is located in a zoning district permitting their use as Guest Lodging, as identified in the zoning use tables found in Chapter 29, Zoning Ordinance. Generally, Guest Lodging is allowed in any of the following zoning districts: A, RL, RM, UCRM, RLP, RH, F- VR, FS-RL, FS-RM, F-PRD, S-SMD, NC, CCR, DSC, CSC, and DGC.

- (c) **Occupancy.**
 - (i) Hosted Home Shares are limited to a maximum of two approved bedrooms and two adults as guests per dwelling unit. The applicant must specify which portions of the dwelling unit will constitute the licensed premises available for use for the Guest Lodging.
 - (ii) Bed & Breakfast Establishments are limited to a maximum occupancy of two adults per approved bedroom. The Zoning Board of Adjustment determines the number of bedrooms specific to the dwelling unit. No more than five bedrooms may be approved.
 - (iii) Home Shares are limited to a maximum of two adults per approved bedroom, not to exceed a total of five adults per dwelling unit.
 - (iv) Apartment Shares are limited to the occupancy standards of Chapter 13, Rental Housing Code.
 - (d) **Off-Street Parking.** Parking is provided according to the requirements of the *Zoning Ordinance Section 29.406* and the following:
 - (i) Hosted Home Shares - No additional parking required.
 - (ii) Bed & Breakfast Establishments - 1 reserved space per guest bedroom, plus 1 space for the owner.
 - (iii) Home Shares - 1 space per bedroom (maximum required - 5 spaces).
 - (iv) Apartment Shares – No additional parking required.
 - (e) **Fire Safety Requirements.** All units must be evaluated with a checklist for fire safety (means of egress and fire protection systems) and owners must ensure continued compliance with fire safety regulations included in *Ames Municipal Code Chapter 13, Division VIII*.
 - (f) **Tax Compliance.** At time of renewal, documentation must be provided indicating that required taxes for the previous year have been paid pursuant to *Ames Municipal Code Section 24.3*.
 - (g) **Special Use Permit.** Bed & Breakfast Establishment owners must obtain a Special Use Permit from the Zoning Board of Adjustment, prior to receiving a Guest Lodging license.
 - (h) **Inspection.** Upon application for a license all Guest Lodging must be made available for City verification and inspection for compliance. Refusal by the applicant to allow such inspection shall be grounds for denial of a license. Subsequent inspections may be conducted as part of a regular periodic inspection program or as required to verify correction of deficiencies, or as necessitated by complaints.
- (2) **Additional Operational Requirements.** In addition to initial application requirements, the following also apply:
- (a) **Concurrent Guest Contracts Not Allowed Within a Dwelling Unit.** Accommodations must be offered as one guest contract only. Bed & Breakfast Establishments are exempt from this limitation and may offer one guest contract per approved bedroom.
 - (b) **Maximum Number of Days per Annual Renewal Period (for Home Shares only).** Home Shares are limited to a total of 90 days per annual renewal period, with each guest contract including a period of 31 days or less.
 - (c) **Mandatory Postings of License.** A copy of the Guest Lodging license issued by the City must be displayed in a prominent location within the interior of the dwelling near the front door.
 - (d) **Registry of Guests.** Each owner must keep a registry of guests accommodated during the licensing period.
 - (e) **Responsiveness to Complaints.** The owner or representative must respond to complaints in a reasonably timely manner and shall maintain a record of the actions taken in response.

Sec. 35.500. ADMINISTRATIVE PROCEDURES.

- (1) **Administrative Rules.** The Enforcement Officer shall have the authority to establish administrative rules and regulations consistent with this code, for the purpose of interpreting, carrying out, and enforcing it.
- (2) **Application Review and Issuance of License including Renewal.**
 - (a) **Application Form.** Application for a Guest Lodging license or license renewal must be on forms provided by the City.
 - (b) **License Fee.** The application fee for a Guest Lodging license or license renewal must be as established by resolution of the City Council. These fees are in addition to any other permit or registration fees that may be required.
 - (c) **Application Submittal and Review.** Complete and accurate information must be provided to the City.
 - (i) **Staff review.** The application will be reviewed by staff within five working days for completeness.
 - (ii) **Incomplete Application.** Any application that does not include all required information will be considered incomplete. In such cases, the City will notify the applicant in writing, explaining the information required. If the applicant does not provide the required information within 31 days of the notice, the application will be deemed withdrawn/denied for lack of responsiveness with no return of application fees.
 - (iii) **Inspection.** All premises being considered for licensure as Guest Lodging must be subject to inspection by the City for the purpose of investigating and determining compliance with the requirements of this code. Should the premises not be made available for inspection when requested, the application will be considered incomplete.
 - (iv) **Approval.** A complete application in compliance with this code will be approved and granted a one-year license.
 - (v) **Conditional Approval.** When circumstances do not warrant a full one-year license, a conditional approval may be granted. A conditional approval allows an applicant to operate while coming into full compliance or while correcting a violation. A conditional approval is time limited for no more than three months and is not renewable.
 - (vi) **Denial including Non-Renewal.** Any violation of the provisions of this code may be considered during the application review and may result in denial or non-renewal. Verified complaints with notice of corrective action involving violations of the zoning code, building code, and/or applicable laws or regulations may be a basis for denying a license. A property owner may not reapply for a license for a period of 12 months for that dwelling unit, if denied a Guest Lodging license based upon this section.
 - (vii) **Notification.** Within 31 days of determining the receipt of a complete application, the applicant will be notified of approval, denial, or additional information needed to approve the request.
- (3) **Term**
 - (a) All licenses shall terminate after one year. Annual applications must be submitted by the property owner of record, prior to expiration of the license.
 - (b) If a Guest Lodging license expires, the dwelling unit may not be used or occupied as Guest Lodging until such time as a subsequent license has been granted for that unit.
- (4) **Transferability.** The license must be issued in the name of the property owner and is not transferable to a subsequent owner or to another property.

(5) **Revocation.**

- (a) The Enforcement Officer may immediately revoke or temporarily suspend a Guest Lodging license based upon any of the following, if it is found that:
 - (i) A required Letter of Compliance has either expired or been revoked;
 - (ii) The licensee, designated operator, or guest has violated any of the provisions of this code or conditions of the license;
 - (iii) The applicant has made a false statement of material fact on an application for a Guest Lodging license;
 - (iv) The licensee, designated operator, or guest has violated any federal, state, or city law or regulation pertaining to the use of the property as Guest Lodging; or
 - (v) The Chief of Police or Fire Chief and/or their designees have determined that the Guest Lodging would pose a serious threat to public health, safety, or welfare.
 - (b) The Enforcement Officer shall send or deliver written notice to the property owner stating the basis for the decision of revocation or suspension, the effective date of the revocation or suspension, the right to appeal the decision, and the procedure for filing an appeal. Any notice of suspension must include information about possible corrective action and time for compliance, as applicable.
 - (c) Upon revocation of a license, the dwelling unit or parcel described in the license is ineligible to receive another license pursuant to this code for one year from the date of revocation.
- (6) **Violations and Penalties.** In addition to the aforementioned actions of revocation, suspension, denial or non-renewal of a license, any violation of any provision of this code may also be enforced as a municipal infraction by the Enforcement Officer. The penalty for a first violation shall be \$500. The penalty for each subsequent violation shall be \$750.

Sec. 35.600. APPEALS.

Any party aggrieved by the Enforcement Officer's decision to deny, suspend, revoke, or issue a license may appeal the determination to the Zoning Board of Adjustment within 31 days, under the procedures set forth in the *Zoning Ordinance Section 29.1403(8)*.

Section Two. Violation of the provisions of this ordinance shall constitute a municipal infraction punishable as set in this ordinance.

Section Three. All ordinances, or parts of ordinances, in conflict herewith are hereby repealed to the extent of such conflict, if any.

Section Four. This ordinance shall be in full force and effect from and after its passage and publication as required by law. Enforcement of this ordinance shall begin on January 1, 2019.

Passed this _____ day of _____, _____.

Diane R. Voss, City Clerk

John A. Haila, Mayor

COUNCIL ACTION FORM

SUBJECT: NUISANCE ASSESSMENTS - SNOW/ICE REMOVAL

BACKGROUND:

After a snowfall, abutting property owners have the responsibility of removing snow and ice accumulations from the sidewalks. According to the *Municipal Code*, owners shall remove these accumulations within 10 daylight hours after the storm has stopped. If, after that time, sidewalks remain uncleared, the City may remove accumulations and assess the actual cost of the removal to the property owner. This action is performed on a complaint basis. Once a complaint has been received, notice is given to the abutting property owner that the City will clear the sidewalks if the owner has not done so within 24 hours of that notice.

City staff has removed snow and/or ice at the properties listed below. Also included in the list are the names and addresses of the property owners and the costs associated with the snow/ice removal. The work was completed, and bills have been mailed to these individuals. To date, the bills have not been paid. A certified notice of this hearing was mailed to the property owners.

Charles O. Thoen, Revocable Trust c/o Tyler Thoen 1205 British Columbia Avenue Ames, IA 50014 Snow/ice removal for property located at 1101 Lincoln Way Work performed on February 27, 2019	\$385.00
Elizabeth C. Binder 324 Dotson Drive Ames, IA 50014 Snow/ice removal for property located at 324 Dotson Drive Work performed on February 28, 2019	\$455.00

ALTERNATIVES:

1. The City Council can adopt a resolution assessing the costs of the snow/ice removal to the property owners shown on the above list. The Finance Director will then prepare a spread sheet on these assessments, and the City Clerk's Office will file the assessments with the Story County Treasurer for collection in the same manner as property taxes as provided for by the *Code of Iowa*.

2. The City Council can choose not to certify these costs to the County Treasurer and, instead, absorb the costs.

MANAGER'S RECOMMENDED ACTION:

These property owners failed to clear their sidewalks even after receiving notice to do so, and have neglected to pay the costs incurred by the City in making their sidewalks safe for public use.

Therefore, it is the recommendation of the City Manager that the City Council adopt Alternative No. 1, thereby assessing the costs of the snow/ice removal to the property owners shown above.

OLD CAF

ITEM: ~~29b-52~~

DATE: ~~07-09-19~~

08-27-19

COUNCIL ACTION FORM

**SUBJECT: PARKING REGULATIONS FOR SCENIC VALLEY SUBDIVISION,
FOURTH ADDITION**

BACKGROUND:

In response to final platting of the Scenic Valley Subdivision, fourth addition, there will be new residential streets added to the city. To maintain safe two-way traffic and access for emergency vehicles parking will need to be prohibited on one side of the street. Typically, parking is prohibited on the same side of the street where the fire hydrants are placed to maximize available parking.

The new streets with proposed parking regulations are as follows:

1. Barcelos Street – No parking at all times on the south side.
2. Everest Avenue – No parking at all times on the east side.
3. Everest Circle – No parking at all times on the east side.

To begin the process, the City Attorney will need to draft an ordinance establishing no parking regulations. A map of the proposed no parking regulations has been provided in Attachment A.

ALTERNATIVES:

1. Direct the City Attorney to draft an ordinance establishing no parking on:
 - a. The south side of Barcelos Street
 - b. The east side of Everest Avenue
 - c. The east side of Everest Circle.
2. Reject the proposed parking regulations.

MANAGER'S RECOMMENDED ACTION:

Establishing consistent no parking regulations will ensure safe access for all users along these new residential streets. Therefore, it is the recommendation of the City Manager that the City Council adopt Alternative No. 1, as noted above.

Attachment A

Scenic Valley Subdivision

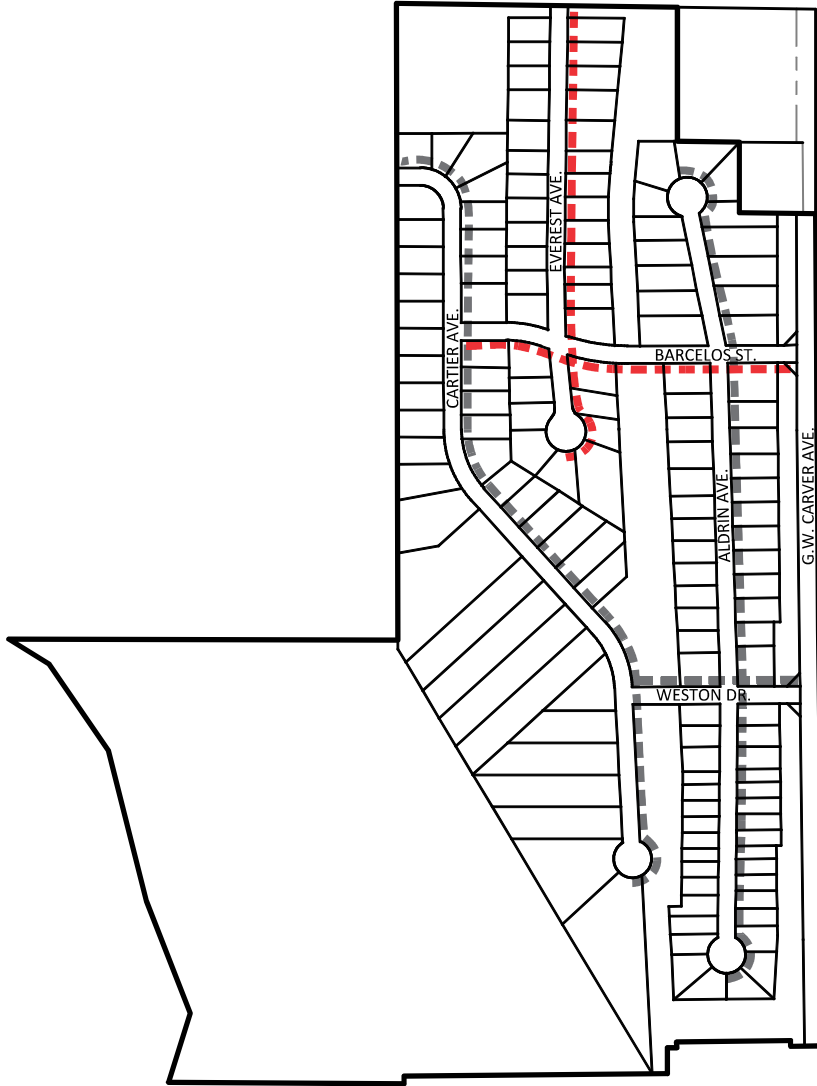

LOCATION MAP

Proposed No Parking - - - - -

Existing No Parking - - - - -

ORDINANCE NO.

AN ORDINANCE TO AMEND THE MUNICIPAL CODE OF THE CITY OF AMES, IOWA, BY ENACTING A NEW CHAPTER 18, SECTION 18.31(377), (378), (379) THEREOF, FOR THE PURPOSE OF PARKING REGULATIONS REPEALING ANY AND ALL ORDINANCES OR PARTS OF ORDINANCES IN CONFLICT TO THE EXTENT OF SUCH CONFLICT; PROVIDING A PENALTY; AND ESTABLISHING AN EFFECTIVE DATE.

BE IT ENACTED, by the City Council for the City of Ames, Iowa, that:

Section One. The Municipal Code of the City of Ames, Iowa shall be and the same is hereby amended by enacting a new Section as follows:

“Sec. 18.31. REGULATIONS FOR SPECIFIC STREETS OR LOCATIONS.

(377) **BARCELOS STREET.** Parking is prohibited at all times on the south side of Barcelos Street.

(378) **EVEREST AVENUE.** Parking is prohibited at all times on the east side of Everest Avenue.

(379) **EVEREST CIRCLE.** Parking is prohibited at all times on the east side of Everest Circle.”

Section Two. Violation of the provisions of this ordinance shall constitute a municipal infraction punishable as set out by law.

Section Three. All ordinances, or parts of ordinances, in conflict herewith are hereby repealed to the extent of such conflict, if any.

Section Four. This ordinance shall be in full force and effect from and after its passage and publication as required by law.

Passed this _____ day of _____, _____.

Diane R. Voss, City Clerk

John A. Haila, Mayor